



ED 110310
110314
110320
110322



GL 110170
110171
110172
110173
110174
110175
110176
110178
110179
200276

ENGLISH

Table of contents

1. Safety 24
1.1 Safety instructions 24
1.2 Key to symbols 26
1.3 Hazard sources 26
1.4 Proper use 28

2. General information 29
2.1 Liability and Warrantees 29
2.2 Copyright protection 29
2.3 Declaration of conformity 29

3. Transport, packaging and storage 30
3.1 Delivery check 30
3.2 Packaging 30
3.3 Storage 30

4. Technical data 31
4.1 Overview of parts 31
4.2 Technical specification 33

5. Installation and operation 36
5.1 Assembly of cooling tops with glass cover 36
5.2 Positioning and connection 37
5.3 Operation 38

6. Cleaning and maintenance 42

7. Possible Malfunctions 43

8. Waste disposal 44

Bartscher GmbH
Franz-Kleine-Str. 28
D-33154 Salzkotten
Germany

phone: +49 (0) 5258 971-0
fax: +49 (0) 5258 971-120



Read these instructions before using and keep them available at all times!

This instruction manual contains information about the installation, operation and maintenance of the device and should be consulted as an important source of information and reference guide.

Awareness of the safety instructions and instructions for use in this manual will ensure the safe and correct use of the device.

In addition to the information given here, you should comply with any local Health and safety Controls and generally applicable safety regulations.

The instruction manual forms part of the product and should be kept near the device and easily accessible for anyone carrying out the installation, servicing, maintenance or cleaning.

Please keep these instructions and give them to future owners of the device.

1. Safety

This device is designed in accordance with the presently applicable technological standards. However, the device can pose a danger if handled improperly and inappropriately.

All persons using the device must follow the recommendations and instructions in this manual.

1.1 Safety instructions

- This device may only be operated in technically proper and safe condition.
- The device is not intended for use by individuals (including children) with physical or mental disabilities, insufficient experience, and/or insufficient knowledge unless such persons are under the care of a person responsible for their safety or have received instructions regarding appropriate use of the device.
- Children should be observed to ensure that they are not playing with the device.
- Only a qualified technician and using original spare parts and accessories should carry out repairs and maintenance of the device.
Do not attempt to repair the device yourself.

- Do not use any accessory or spare parts that have not been recommended by the manufacturer. These can be dangerous for the user or lead to damages of the device or personal injury, and further, the warranty expires.
- To prevent hazards and to ensure optimum efficiency, no modifications or alterations to the device that are not explicitly approved by the manufacturer may be undertaken.
- Never allow the power cable to come into contact with heat sources or sharp edges. The power cable should not hang over the side of the working surface. Ensure that no one can step on or trip over the cable.
- The power cable must not be folded, bent or tangled, and must always remain fully unrolled.
- Never place the device or other objects on the power cable.
- Do not lay the cable over carpets or heat insulations. Do not cover the cable. Keep away the cable from operating range and do not dunk it into water.
- Inspect the power cable regularly for damage. Never use the device if the cable is damaged. If the power cable is damaged, have an authorised service center or qualified electrician replace it.
- The device is not adapted for use with an external timer or remote control.
- **Never** leave the device unattended when in use.
- Do not move or tilt the device when in operation.
- Only use the device indoors.

1.2 Key to symbols

In this manual, symbols are used to highlight important safety instructions and any advice relating to the device. The instructions should be followed very carefully to avoid any risk of accident, personal injury or material damage.



WARNING!

This symbol highlights hazards which could lead to injury.



WARNING!

This symbol highlights dangerous situations which could lead to injury or death.



WARNING! Hot surface!

This symbol is a warning that the device surface is hot when in use. Ignoring this warning may result in burns!



CAUTION!

This symbol highlights dangerous situations which could lead to light injuries, or damage, malfunction, and/or destruction of the device.



NOTE!

This symbol highlights recommendations and information aimed for effective and trouble-free device operation.

1.3 Hazard sources



DANGER!

Electric shock hazard!

To avoid the hazard results please follow the safety instructions below.

- Do not use the machine in case of incorrect operation, damages or dropping on the floor.
- The supply cable must be disconnected from the socket only by pulling the plug.
- Never carry or lift the device by the supply cable.

- In any case do not open the device housing. In case of electrical or mechanical modifications the electric shock hazard will occur.
- Never immerse the plug in water or other liquids.
- Never operate the device with moist hands or standing on wet floor.
- Remove the plug from its socket:
 - when the device is not used,
 - in case of anomalies during operation,
 - before cleaning.



DANGER!

Suffocation hazard!

- Prevent access of children to the package materials like plastic bags and foamed polystyrene elements.



WARNING! Hot surface!

Burn hazard!

To avoid the hazard results please follow the safety instructions below.

- During normal operation the compressor surface may be hot. Do not touch it with bare hands.



WARNING!

Fire or explosion hazard!

In case of improper operation there is the fire or explosion hazard due to ignition of the device content.

To avoid the hazard results please follow the safety instructions below.

- Do not store the flammable or explosive substances in the device, like ether, kerosene, or glues.
- Do not clean the device with use of flammable liquids. The released vapours may cause fire or explosion.

- Do not store gasoline or other flammable substances in the vicinity of the device. The vapours may cause fire or explosion.
- Do not store the explosive objects in the device, like cans with explosive work substances.
- Do not allow for the cooling circuit damages.

1.4 Proper use



CAUTION!

The device has been designed and constructed only for commercial use and should be operated by qualified personnel of restaurants, cafeterias, bars and similar facilities.

The operational safety of the device is assured only in case of proper use, according to the operation manual.

All technical activities like installation and maintenance must be performed by the qualified service personnel only.

The **cool display top** is designed **only** for **cooling of food products** in appropriate GN containers.

Do not use the cool display top for any of the following:

- storing of the flammable or explosive substances in the device, like ether, kerosene, or glues;
- storing of pharmaceutical products or preserved blood.



CAUTION!

Any use going beyond the intended purpose and/or any different use of the device is forbidden and is not considered as conventional.

Any claims against the manufacturer or his authorized representative as a consequence of experiencing damages resulting from unconventional use are impossible.

The operator is liable for all damages resulting from inappropriate use.

2. General information

2.1 Liability and Warrantees

All the information and instructions in this manual take into account standard safety regulations, current levels of technical engineering as well as the expertise and experience we have developed over the years.

The instruction manual was translated with all due care and attention. However, we do not accept liability for any translation errors. The German version of this instruction manual is definitive.

If the delivery consists of a special model, the actual scope of delivery may differ from the descriptions and illustrations in this manual. This is also the case for special orders or when the device has been modified in line with new technology.



CAUTION!

Read this manual carefully and thoroughly before any operation of the device, and especially before turning it on!

Manufacturer **is not liable** for any damages or faults caused by:

- violation of advice concerning operation and cleaning;
- use other than designed;
- alterations made by user;
- use of inadequate spare parts.

We reserve the right to make technical changes for purposes of developing and improving the useful properties.

2.2 Copyright protection

The instruction manual including any texts, drawings, images or other illustrations is copyright. No part of this publication may be reproduced, transmitted or used in any form or by any means without permission in writing from the manufacturer. Any person who commits any unauthorized act in relation to this publication shall be liable to claims for damages. All rights reserved.



NOTE!

The contents, texts, drawings, pictures and any other illustrations are copyright and subject to other protection rights. Any person unlawfully using this publication is liable to criminal prosecution.

2.3 Declaration of conformity



The device complies with the current standards and directives of the EU. We certify this in the EC declaration of conformity. If required we will be glad to send you the according declaration of conformity.

3. Transport, packaging and storage

3.1 Delivery check

Please check the delivery upon completeness and transport damage immediately after receipt. In case of visible damage do not accept or accept the delivery with reservation only.

Note the extent of damage on the carrier's bill of delivery. Trigger off the complaint.

Hidden damages should be reclaimed immediately after notice, as claims for damages can only be asserted within the effective period for complaints.

3.2 Packaging

Please do not throw away the covering carton of your device as it might be useful for storage purposes, when moving or, in case of damages, when the device must be sent back to a repair center. The outer and inner packing material should be removed completely from the device before installation.



NOTE!

If you liked to dispose the packing, consider the regulations applicable in your country. Supply re-usable packing materials to the recycling.

Please inspect the device upon completeness. In case any part is missing please contact our customer service center immediately.

3.3 Storage

Keep the package closed until installation and under consideration of the outside indicated positioning- and storage markings.

Packages should be stored under consideration of the following:

- Do not store outdoors.
- Keep it dry and dust-free.
- Do not expose it to aggressive media.
- Do not expose it to direct sunlight.
- Avoid mechanical shocks and vibration.
- In case of longer storage (> 3 months) make sure you check the state of the packaging and the parts regularly.
If required refresh or renew.

4. Technical data

4.1 Overview of parts

Cooling Tops ED (with stainless steel cover)

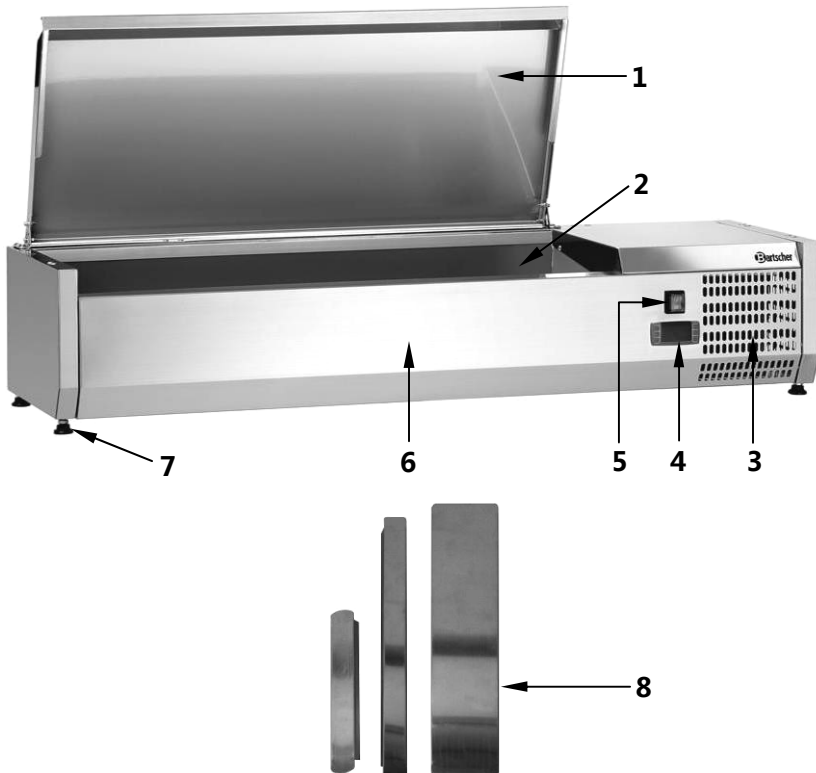

- 1 Stainless steel lid
- 2 Trough for GN containers
- 3 Ventilation holes
- 4 Digital temperature controller
- 5 Main switch
- 6 Housing
- 7 Feet (4)
- 8 Bridges

Cooling Tops GL (with glass cover)

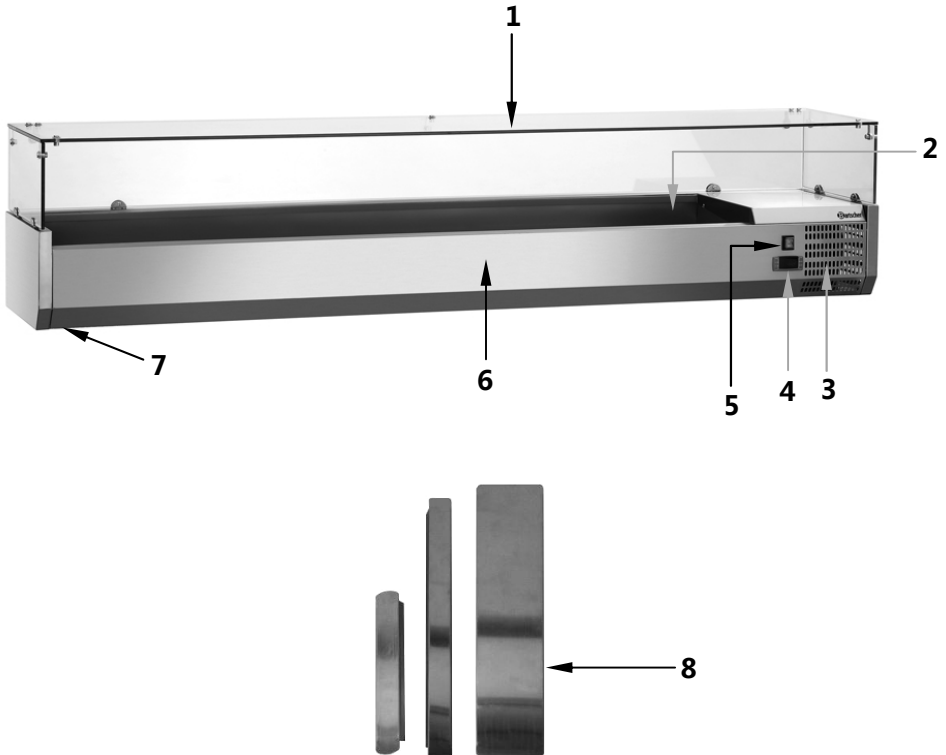

- 1 Glass cover
- 2 Tray for placing GN containers
- 3 Ventillation ducts
- 4 Digital temperature regulator
- 5 Main switch
- 6 Housing
- 7 Feet (4)
- 8 Bridges

4.2 Technical specification

Cooling tops ED

for GN containers of depth of 150 mm***, with stainless steel lid

- chrome-nickel steel with stainless steel lid
- electronic control
- water condensate evaporation
- digital temperature controller
- cooling device with trough for cooling
- static cooling
- R134a coolant
- operating temperature:: 0 °C to 10 °C

***Delivery without GN containers

Name	Cooling tops ED	
	5 x 1/4 GN	7 x 1/4 GN
Code no.:	110310	110314
Power supply:	0.166 kW / 230 V 50 Hz	0.174 kW / 230 V 50 Hz
Dimensions:	W 1200 x D 340 x H 275 mm	W 1500 x D 340 x H 275 mm
Weight:	23.6 kg	26.0 kg
Auxiliary equipment:	4 bridges: 180 x 25 x 10 mm 6 bridges: 266 x 27 x 10 mm	4 bridges: 180 x 25 x 10 mm 6 bridges: 266 x 27 x 10 mm

Name	Cooling tops ED	
	3 x 1/3 GN + 1 x 1/2 GN	5 x 1/3 GN + 1 x 1/2 GN
Code no.:	110320	110322
Power supply:	0.166 kW / 230 V 50 Hz	0.174 kW / 230 V 50 Hz
Dimensions:	W 1200 x D 400 x H 275 mm	W 1500 x D 400 x H 275 mm
Weight:	24.8 kg	27.8 kg
Auxiliary equipment:	4 bridges: 180 x 25 x 13 mm 6 bridges: 326 x 25 x 13 mm	4 bridges: 180 x 25 x 13 mm 6 bridges: 326 x 25 x 13 mm 1 bridge: 326 x 76 x 13 mm

We reserve the right to make technical changes!

Cooling tops GL

For GN containers, depth: 100 mm^{***}, with glass cover

- Stainless steel housing, glass cover
- electronic control
- water condensate evaporation
- digital temperature controller
- cooling device with trough for cooling
- static cooling
- R134a coolant
- operating temperature:: 0 °C to 10 °C

***Delivery without GN containers

Name	Cooling tops GL4	
	GL4 5 x 1/4 GN	GL4 6 x 1/4 GN
Code no.:	110170	110171
Power supply:	0.166 kW / 230 V 50 Hz	0.194 kW / 230 V 50 Hz
Dimensions:	W 1200 x D 340 x H 425 mm	W 1400 x D 340 x H 425 mm
Weight:	36.4 kg	40.6 kg
Auxiliary equipment:	1 bridge: 264 x 42 x 13 mm 4 bridges: 181 x 25 x 13 mm 4 bridges: 264 x 25 x 13 mm	1 bridge: 264 x 78 x 13 mm 4 bridges: 181 x 25 x 13 mm 5 bridges: 264 x 25 x 13 mm

Name	Cooling tops GL4	
	GL4 7 x 1/4 GN	GL4 8 x 1/4 GN
Code no.:	110172	110173
Power supply:	0.174 kW / 230 V 50 Hz	0.180 kW / 230 V 50 Hz
Dimensions:	W 1500 x D 340 x H 425 mm	W 1800 x D 340 x H 425 mm
Weight:	41.4 kg	46.8 kg
Auxiliary equipment:	4 bridges: 181 x 25 x 13 mm 5 bridges: 264 x 25 x 13 mm	4 bridges: 181 x 25 x 13 mm 8 bridges: 264 x 25 x 13 mm

Name	Cooling top GL4
	GL4 10 x 1/4 GN
Code no.:	110174
Power supply:	0.194 kW / 230 V 50 Hz
Dimensions:	W 2000 x D 340 x H 425 mm
Weight:	51.0 kg
Auxiliary equipment:	4 bridges: 181 x 25 x 13 mm 10 bridges: 264 x 25 x 13 mm

Name	Cooling tops GL3	
	GL3 3 x 1/3 + 1 x 1/2 GN	GL3 5 x 1/3 + 1 x 1/2 GN
Code no.:	110175	110176
Power supply:	0.166 kW / 230 V 50 Hz	0,74 kW / 230 V 50 Hz
Dimensions:	W 1200 x D 400 x H 425 mm	W 1500 x D 400 x H 425 mm
Weight:	39.2 kg	45.4 kg
Auxiliary equipment:	4 bridges: 180 x 25 x 13 mm 5 bridges: 326 x 25 x 13 mm	4 bridges: 180 x 25 x 13 mm 5 bridges: 326 x 25 x 13 mm

Name	Cooling tops GL3	
	GL3 8 x 1/3 GN	GL3 9 x 1/3 GN
Code no.:	110178	110179
Power supply:	0.180 kW / 230 V 50 Hz	0.194 kW / 230 V 50 Hz
Dimensions:	W 1800 x D 400 x H 425 mm	W 2000 x D 400 x H 425 mm
Weight:	51.9 kg	55.4 kg
Auxiliary equipment:	4 bridges: 180 x 25 x 13 mm 8 bridges: 326 x 25 x 13 mm	4 bridges: 180 x 25 x 13 mm 9 bridges: 326 x 25 x 13 mm

Name	Cooling top GL3
	GL3 9x 1/3 GN
Code no.:	200276
Power supply:	0.212 kW / 230 V 50 Hz
Dimensions:	W 2025 x D 400 x H 425 mm
Weight:	55.4 kg
Auxiliary equipment:	1 bridge: 326 x 66 x 14 mm 4 bridges: 182 x 25 x 14 mm 9 bridges: 326 x 25 x 14 mm

We reserve the right to make technical changes!

5. Installation and operation

5.1 Assembly of cooling tops with glass cover

- Unpack the device and remove the packing material.
- Cooling tops **ED** (with stainless steel cover) are pre-assembled and after placing them at the intended place they may be turned on.
- The cooling cover of the cooling tops **GL** is disassembled and its parts are separately packed.
- First, check against the table below whether all the delivered parts are present.

Scope of delivery for the cooling top with glass cover (see figure on page 37)

	Name	Quantity		Name	Quantity
1	Glass handle	6 pcs	7	Right glass pane	1 piece
2	Screw for glass handles	12 pcs	8	Angle for glass panes	7 pcs
3	Threaded stud	6 pcs	9	Cylindrical head screw	14 pcs
4	Left glass pane	1 piece	10	Rubber ring	14 pcs
5	Upper glass pane	1 piece	11	Locking screw	14 pcs
6	Rear glass pane	1 piece	12	Cooling top housing	1 piece



NOTE!

2 people should perform the installation of the glass cover!

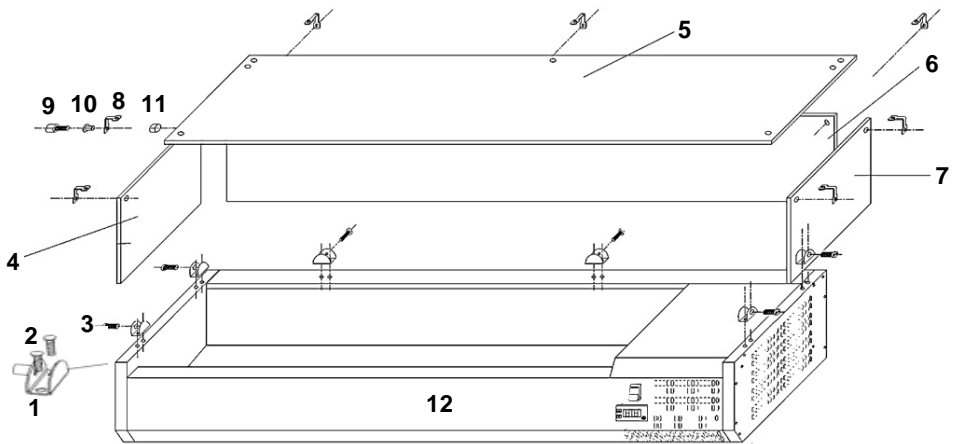

1. Start the installation from fastening the glass handles (1) (2 on the left side, right side and at the rear) on the housing of the cooling top. Use the delivered screws for glass handles (2).
2. Fit the left (4), right (7) and rear (6) glass panes in the installed glass handles (1). Manually tighten the threaded studs (3) of glass panes. **Do not overtighten the studs as the glass may break!**
3. Using the cylindrical head screws (9), rubber rings (10) and locking screws (11) mount two angles (8) in the corners on the left (4), right (7) and rear (6) glass pane and 1 angle (8) in the middle of the rear glass pane.
4. Next, place the upper glass pane (5) on the right (7), left (4) and rear (6) glass pane and fasten it to the angles on the right and left sides as well as at the rear.
5. Finally, check whether all the glass panes have been tightly secured.

5.2 Positioning and connection

Positioning

- Position the device in safe place of load capacity sufficient for weight of the device with full content.
- **Never** place the device in humid or wet environment.
- **Never** place the device on the flammable surfaces.
- In order to avoid the compressor damages do not tilt the device during positioning or transport by more than 45°.
- **Do not** place the device in the vicinity of open fire, electric ovens, heating furnaces, or other heat sources like direct sunlight. High temperature may damage the device surface and may impact the cooling capacity and energy consumption.

- Place the device so as to allow proper air circulation. Keep a minimum distance of 10 cm from the rear, 10 cm at the sides from the walls or other objects. In case of the cooling tops ED, keep the appropriate distance from cabinets, shelves etc., to allow easy opening of the stainless steel cover. At the front (service panel) leave enough space for the personnel to work with the device.
- Never block or cover ventilation ducts of the device around the cooling unit at the front and the rear as well as on the right side.
- Place the device so that the plug is easily accessible in order to quickly disconnect the device from the power supply if need arises.
- After placing the device in the intended place, level it by tightening or loosening the feet.
- Remove the protection foil from the device before the first use.



CAUTION!

- **Never** remove the rating plate and any warning signs from the device.

Connection



DANGER! Electric shock hazard!

The device can cause injuries due to improper installation!

Before installation and connecting the local power grid specification should be compared with that of the device (see rating plate). Connect the device only in case of compliance!

Connect the device only to properly installed single socket with protective terminal.

- The electrical circuit in the socket must be secured to at least 16A. Only connect the device directly to the wall socket; do not use any extension cords or power strips.

5.3 Operation

Preparation and start-up

- Clean the cool display top before use. Follow the instructions in section 6 “**Cleaning and maintenance**”.
- Start the cool display top (without food products). Follow the instructions in sections below.
- Connect the device to the single grounded socket.

- Connect the device by switching the main switch in front of the device to “I” (ON) position. Green diode at the switch will come on and the digital display will show the current temperature in the device.
- The GN containers with food products should be placed in the cooling trough only when the required temperature stabilizes in the device.

Digital temperature control

Basic settings of the temperature are pre-set and reflect the operating temperature in the range of 0 °C – 10 °C inside of the device.

During normal operation of the device the digital display indicates the current temperature inside of the device.



Button Functions

SET	Display a required value, select parameters in programming mode or save the procedure
	Manual start of defrost
	In programming mode, select a parameter code, increase the displayed value
 AUX	In programming mode, select a parameter code, decrease the displayed value

Combination of buttons

To activate or deactivate some of the functions you may need to press more than one button at the same time.



Block or unblock the buttons:

- to block, press both buttons and hold longer than 3 seconds, until you see “OFF” on the display;
- to unblock, press both buttons and hold longer than 3 seconds, until you see “ON” on the display.



Switch to programming mode:

- press both buttons and hold for 3 seconds, LED **C** or **F** flashes, and you can start programming.

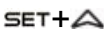





Return to a previous indication:

- press both buttons to leave the programming mode and return to a previous displayed value (temperature inside of the device).

LED indicators



LED indicators on the digital display indicate the active function:

LED	Display	Meaning
	illuminates	compressor active
	flashes	delayed
	illuminates	defrost in progress
	flashes	defrost delayed
	illuminates	indicates temperature standard
	flashes	in programming mode
	illuminates	indicates temperature standard
	flashes	in programming mode

Indication of required value

- shortly press button **SET** to show the required temperature;
- press button **SET** again or wait 5 seconds to return to the previous indication.

Change of required value (required temperature)

- press and hold button **SET** for at least 3 seconds;
- the required value will be displayed and the diode **C** or **F** will flash on the display;
- use button  or  to decrease or increase the value until the display shows the required value;
- confirm new value with button **SET** or wait 10 seconds for the automatic storing of set value.



NOTE!

Other settings may be changed according to the attached digital controller manual or by ordering it to the professional personnel.



Device deactivation

In case of planned break in the device operation turn it off with use of main switch (position “**O**” (**OFF**)) and disconnect from the power supply (remove the plug from the socket!).

Defrosting



Automatic defrosting

The device automatically defrosts 4 times per 24 hours. The timer is started when the device is activated for the first time.

In order to set other period for the automatic defrosting press button  for more than 2 seconds. The digital display will show symbol "".

Defrosting will begin immediately, each successive defrosting will take place after 6 hours.

Manual defrosting

Beside the automatic defrosting it is possible to activate the manual defrosting at any moment by pressing button  for more than 2 seconds. The manual defrosting will begin. The digital display will show symbol "".

Tips for the user

- Place the food products inside the cooling top only when the value of the set temperature appears on the digital display.
- Food products should be placed only in appropriate GN containers (section **4.2 „Technical data”**).
- Do not place warm food inside the cooling top, but leave them to cool off first.
- Place GN containers with food products in the tray for containers. If necessary, the delivered bridges may be used as shelves for GN containers.
- To avoid odors inside the cooling top, observe the indicated expiry dates of food products.
- If condensation gathers at the bottom of the cooling tray, remove it with soft, dry cloth.
- After a power failure or after pulling the plug, do not reconnect it to a power source for at least 5 minutes.

For devices with the stainless steel cover, observe the following instructions.

- After the cooling top has been filled, close the stainless steel cover.
- To avoid losses of cold air during the cooling process, do not keep the stainless steel cover open longer than necessary. Furthermore, do not open it too often.
- In the event of the power failure, the cover should remain closed to avoid losing the cooled air from the device.

6. Cleaning and maintenance



CAUTION!

Before cleaning, disconnect the device from the power supply (pull the plug out of the socket!).

The device is not suited for direct washing with water jets. Therefore, you must not use any kind of pressure water jet for cleaning the device!

Make sure no water gets into the device.

Regular cleaning by the operating personnel

- The device should be periodically cleaned for the hygienic and functional reasons.
- Before cleaning remove the food products from the device and put them in the refrigerator to avoid decay.
- **Never** use aggressive cleaning agents, such as scouring powders, alcohol-based substances, or solvents which may damage the surfaces of the device.

Accessories

- Remove GN containers and bridges from the device and wash them in warm water with food grade cleaning agent. Rinse with clean water.
The accessories may be also cleaned in the dishwasher.

Cooling top

- Clean **the cooling tray, stainless steel cover or glass cover** thoroughly **inside and outside** with soft cloth soaked with soap. Rinse with fresh water.
- Clean **the housing** of the cooling top with soft, wet cloth. If necessary, apply a mild cleaning agent.
- Wipe dry and polish the cleaned elements with soft, dry cloth.

Regular maintenance performed by professional personnel

- In order to maintain efficiency the condenser must be cleaned regularly (once a week).
- Access to the condenser unit is possible only by unscrewing the fixing bolts and removing the cover with use of special tools.
- The condenser should be cleaned with vacuum cleaner or brush by careful moving the suction nozzle or brush along the ribs.

- Avoid using hard objects or metal tools which may damage the condenser ribs.
- Replace the cover after cleaning.
- Check correctness of operation of temperature sensor and controller.
- Make sure that there are no loose electric connections.

In case of planned longer interruption in operation:

- turn the device off (main switch in "O" (OFF) position) and disconnect the electric power supply (pull the plug!);
- remove all food products from the device;
- clean the device according to the description presented in section „**Cleaning and maintenance**“. For cooling top ED, leave the stainless steel cover open for some time to let the device dry thoroughly;
- store closed device in dry, clean place, protected from frost and sunlight, and inaccessible for children. Never place heavy objects on the device.

7. Possible Malfunctions

In case of failure turn the device off with the main switch and disconnect the device from the power supply (pull the plug!). Before calling the technician or informing the vendor check the possibility of removing the failure by yourself according to the table below.

Failure	Possible reason	Solution
The cooling unit does not start	<ul style="list-style-type: none"> • The device is turned off. • No power supply. 	<ul style="list-style-type: none"> • Turn the device on with use of main switch. • Check power supply, plug, socket, fuse.
Continuous operation of cooling unit with insufficient cooling	<ul style="list-style-type: none"> • Too high environment temperature. • Poor air circulation around the device. • Insufficient coolant level. • Contaminated condenser. 	<ul style="list-style-type: none"> • Ventilate the device location or move it away from heat sources. • Maintain sufficient distance to the walls and other objects. • Contact the vendor. • Order the condenser cleaning.

Failure	Possible reason	Solution
The cooling unit does not stop	<ul style="list-style-type: none"> • Damaged temperature sensor. • Damaged temperature controller 	<ul style="list-style-type: none"> • Contact the vendor. • Contact the vendor.
The device operation is too loud	<ul style="list-style-type: none"> • Insufficient distance to the walls and other objects. 	<ul style="list-style-type: none"> • Assure sufficient distances to the walls / other objects.

When the anomalies cannot be removed:

- **do not** open the housing,
- contact the service company or the vendor, and specify:
 - failure type;
 - article number and serial number (see rating plate on the back wall).

8. Waste disposal

Discarding old devices

At the end of its service life the discarded device has to be disposed in accordance with the national regulations. It is advisable to contact a company which is specialized in waste disposal, or just contact the local disposal service in your community.



WARNING!

To exclude any abuse and the dangers involved make the waste device unfit for use before disposal. For that purpose disconnect device from mains supply and remove mains connection cable from the device.



CAUTION!



For the disposal of the device please consider and act according to the national and local rules and regulations.

Bartscher GmbH
 Franz-Kleine-Str. 28
 D-33154 Salzkotten
 Germany

phone: +49 (0) 5258 971-0
 fax: +49 (0) 5258 971-120