



**110270 - 110271 - 110272 - 110273 -
110274 - 110275 - 110276 - 110278 -
110279**

Bartscher GmbH
Franz-Kleine-Str. 28
D-33154 Salzkotten
Germany

Phone: +49 5258 971-0

Fax: +49 5258 971-120

Technical Support Hotline: +49 5258 971-197

www.bartscher.com



Version: 1.0

Date of preparation: 2021-08-30

Original instruction manual

1	Safety	2
1.1	Explanation of Signal Words.....	2
1.2	Safety instructions.....	3
1.3	Intended Use	6
1.4	Unintended Use	6
2	General information	7
2.1	Liability and Warranty	7
2.2	Copyright Protection	7
2.3	Declaration of Conformity	7
3	Transport, Packaging and Storage	8
3.1	Delivery Check.....	8
3.2	Packaging	8
3.3	Storage	8
4	Technical Data.....	9
4.1	Technical Specifications	9
4.2	Functions of the Appliance.....	14
4.3	List of Components of the Appliance	15
5	Installation and operation	16
5.1	Installation.....	16
5.2	Operation	19
6	Cleaning and Maintenance	23
6.1	Safety Instructions for Cleaning	23
6.2	Cleaning.....	24
6.3	Maintenance	24
7	Possible Malfunctions.....	25
8	Disposal.....	26



Read this instruction manual before using and keep it available at all times!

This instruction manual contains information about installation, operation and maintenance of the appliance and constitutes an important source of information and reference guide. The knowledge of all operational and safety instructions included in this manual is a prerequisite for safe and proper handling of the appliance. Additionally, accident prevention, occupational health and safety, and legal regulations in force in the area the appliance is used apply.

Before you start using the appliance, especially before turning it on, read this instruction manual in order to avoid personal injuries and property damages. Improper use may cause damage.

This instruction manual forms an integral part of the product and must be stored in an immediate vicinity of the appliance and be available at all times. The instruction manual should be transferred together with the appliance.

1 Safety

EN

This appliance has been manufactured in accordance with technical standards currently in force. However, the appliance may be a source of hazards if used improperly or contrary to its intended purpose. All persons using the appliance must consider information included in this instruction manual and observe safety instructions.

1.1 Explanation of Signal Words

Important safety instructions and warning information are indicated in this instruction manual with appropriate signal words. You must strictly follow the instructions, to prevent accidents, personal injuries and property damages.



DANGER!

The signal word **DANGER** warns against hazards that lead to severe injuries or death if the hazards are not avoided.



WARNING!

The signal word **WARNING** warns against hazards that may lead to moderate or severe injuries or death if the hazards are not avoided.



CAUTION!

The signal word **CAUTION** warns against hazards that may lead to light or moderate injuries if the hazards are not avoided.

IMPORTANT!

The signal word **IMPORTANT** indicates possible property damages, which may occur if safety instructions are not observed.

NOTE!

The symbol **NOTE** indicates subsequent information and guidelines for the user on usage of the appliance.

1.2 Safety instructions

Electrical Current

- Too high a mains voltage or incorrect installation may cause electric shock.
- The appliance may be connected only if data on the rating plate correspond with the mains voltage.
- To avoid short-circuit, the appliance should be kept dry.
- If there are malfunctions during operation, disconnect the appliance from the power supply.
- Do not touch the appliance's plug with wet hands.
- Never take hold of the appliance if it has fallen into water. Immediately disconnect the appliance from the power supply.
- Any repairs or housing opening may be carried out by professionals and relevant workshops only.
- Do not transport the appliance, holding it by the power cord.
- Do not allow the power cord to come into contact with heat sources or sharp edges.
- Do not bend, pinch nor knot the power cord.

- Always completely unwind the power cord.
- Never place the appliance or other objects on the power cord.
- Always take hold of the plug to disconnect the appliance from the power supply.
- Check the power cord regularly for damage. Do not use the appliance if the power cord is damaged. If this cable is damaged, it must be replaced by customer service or a qualified electrician in order to avoid dangers.

Fire hazard / flammable materials hazard / explosion hazard!

- Do not use any electric devices in the appliance.
- Do not store nor use petrol or other flammable liquids and gases in the vicinity of this or any other appliance. Those gases may cause fire or explosion hazard.
- Do not put into the appliance any explosive materials, like sprays filled with flammable propellants. Contents of containers filled with flammable gases and liquids may leak in low temperatures, and the contents may catch fire from sparks generated by an electric appliance. Explosion hazard!
- In the case of coolant leakage, pull the plug from the socket. Remove all sources of ignition in the vicinity, ventilate room and contact technical service. Avoid coolant getting in contact with eyes, as it may cause serious eye damage.
- Never use any flammable liquids for cleaning the appliance or its parts. Gases released may cause fire or explosion hazard.
- In the case of fire, disconnect the appliance from the power supply before attempting adequate fire-extinguishing actions.
- Never attempt to extinguish fire with water if the appliance is connected to the power supply. Following extinction of fire, ensure sufficient fresh air inflow.
- Defrosting process may not be sped up with mechanical means or heat energy sources (candles or heaters) nor with any other means. Vapour produced may cause short-circuit and too high temperatures may damage the appliance.
- All ventilation slots should not be obstructed during operation.
- Never attempt to damage cooling installation of the appliance.

EN

Operating Personnel

- The appliance may only be operated by qualified personnel and trained specialist personnel.
- This appliance may not be operated by persons (including children) with limited physical, sensory or mental capabilities, nor by persons with limited experience and/or limited knowledge.
- Children should be supervised to ensure that they are not playing with or switching on the appliance.

Improper Use

- Unintended or prohibited use may cause damage to the appliance.
- The appliance may only be used when its technical condition is flawless and allows for safe operation.
- The appliance may only be used when all connections are executed according to rules of law in force.
- The appliance may only be used when it is clean.
- Use only original spare parts. Never attempt to repair the appliance on your own.
- Do not introduce any changes in the appliance nor modify it.

1.3 Intended Use

As described below, every use of the appliance for a purpose differing and/or diverging from its intended standard use, is prohibited and considered to be an unintended use.

The following is an intended use:

- Cooling food products in suitable GN containers.

1.4 Unintended Use

An unintended use may lead to personal injuries or property damages caused by hazardous voltage, fire or high temperature. The appliance may only be used to perform tasks described in this instruction manual.

The following is an unintended use:

- Storing flammable or explosive objects and liquids, such as ether, petroleum or adhesives;
- Storing explosive materials, like sprays filled with flammable propellants;
- Storing pharmaceutical products or preserved blood;
- Storing live pets.

2 General information

2.1 Liability and Warranty

All information and instructions in this instruction manual account for legal regulations in force, current level of technical engineering knowledge as well as our expertise and experience, developed over the years. If special models or additional options are ordered, or state-of-the-art technical solutions were implemented, the actual scope of delivery of the appliance may, in some circumstances, differ from descriptions and numerous drawings in this instruction manual.

The manufacturer is not liable for any damages nor faults stemming from:

- failure to observe instructions,
- unintended use,
- technical alterations introduced by the user,
- usage of unapproved spare parts.

We reserve the right to introduce technical modifications to the product, intended for improvement of the appliance and its performance.

2.2 Copyright Protection

This instruction manual, and texts, drawings and images included in it, as well as its other components are copyright protected. It is prohibited to reproduce this instruction manual (including its excerpts), in any form and by any means, and to use and/or transfer its content to third parties without manufacturer's written permission. Violation of the above results in obligation to pay compensation. We reserve the right to claim further damages.

EN

2.3 Declaration of Conformity

The appliance meets the currently applicable standards and guidelines of the European Union. We confirm the above in the EC Declaration of Conformity. We may provide relevant Declaration of Conformity upon request.

3 Transport, Packaging and Storage

3.1 Delivery Check

Immediately upon reception, check the delivery for completeness and possible shipping damage. In the case of visible transport damage refuse to accept the appliance or accept it conditionally. Mark and note the scope of damage in shipping documents/consignment list of the shipping company and lodge a complaint. Concealed damage must be reported immediately upon its discovery, as compensation claims may only be filed within applicable time limits.

If you find that parts or accessories missing, please contact our Customer Service Department.

3.2 Packaging

Do not dispose of the appliance cardboard box. It may be used to store the appliance when relocating or when shipping the appliance to our service point in the case of any damages.

The packaging and its elements are made of recyclable materials. Particularly, these are: plastic films and bags, cardboard box.

EN

When disposing of the packaging, observe applicable domestic regulations. Recyclable packaging materials should be recycled.

3.3 Storage

Leave the packaging closed until installation of the appliance; observe external indications concerning method of placing and storage. Store the packaging in the following conditions only:

- in closed rooms;
- in dry and dust-free surrounding;
- away from aggressive agents;
- in a location protected against sunlight;
- in a location protected against mechanical shocks.

In the case of extended storage (over three months), make sure you check the condition of the packaging and the parts regularly. If needed, replace the packaging with a new one.

4 Technical Data

4.1 Technical Specifications

Version / Characteristics of Cooling Tops GL

- Cooling: static
- Climate class: N
- Temperature control: digital
- Temperature range: 0–10°C
- Control: electronic, button
- Digital display
- ON/OFF switch
- Indicator light: ON/OFF
- Automatic defrost function
- Evaporation of condensed water
- Characteristics: cooling aggregate with cooling tray
- Delivery form: self-assembly set (simple assembly)
- Version of glass top at rear side: open
- Front glass: chamfered
- Type of glazing: single glazing, safe glass
- Max. GN container depth: 150 mm
- The set does not include: GN containers

We reserve the right to implement technical modifications.

Name:	Cooling top GL4-1201
Art. No.:	110270
Material:	chrome-nickel steel, glas
Number of GN containers:	5 x 1/4 GN
Coolant, amount in kg:	R290 / 0,030
Connected load:	0,166 kW 230 V 50 Hz
Dimensions of glass top (W x D x H), in mm:	1.190 x 330 x 195
Dimensions (W x D x H), in mm:	1.200 x 335 x 459
Weight, in kg:	36,5

The set includes:

- 4 bars, length 181 mm, width 25 mm
- 6 bars, length 264 mm, width 25 mm

EN

Name:	Cooling top GL4-1401
Art. No.:	110271
Material:	chrome-nickel steel, glas
Number of GN containers:	6 x 1/4 GN
Coolant, amount in kg:	R290 / 0,030
Connected load:	0,194 kW 230 V 50 Hz
Dimensions of glass top (W x D x H), in mm:	1.390 x 330 x 195
Dimensions (W x D x H), in mm:	1.400 x 335 x 459
Weight, in kg:	40,5

The set includes:

- 1 bar, length 264 mm, width 63 mm
- 4 bars, length 181 mm, width 25 mm
- 6 bars, length 264 mm, width 25 mm

Name:	Cooling top GL4-1501
Art. No.:	110272
Material:	chrome-nickel steel, glas
Number of GN containers:	7 x 1/4 GN
Coolant, amount in kg:	R290 / 0,030
Connected load:	0,174 kW 230 V 50 Hz
Dimensions of glass top (W x D x H), in mm:	1.490 x 330 x 195
Dimensions (W x D x H), in mm:	1.500 x 335 x 459
Weight, in kg:	41,5

The set includes:

- 4 bars, length 181 mm, width 25 mm
- 6 bars, length 264 mm, width 25 mm

EN

Name:	Cooling top GL4-1801
Art. No.:	110273
Material:	chrome-nickel steel, glas
Number of GN containers:	8 x 1/4 GN
Coolant, amount in kg:	R290 / 0,033
Connected load:	0,18 kW 230 V 50 Hz
Dimensions of glass top (W x D x H), in mm:	1.790 x 330 x 195
Dimensions (W x D x H), in mm:	1.800 x 335 x 459
Weight, in kg:	47,0

The set includes:

- 1 bar, length 264 mm, width 134 mm
- 4 bars, length 181 mm, width 25 mm
- 8 bars, length 264 mm, width 25 mm

Name:	Cooling top GL4-2001
Art. No.:	110274
Material:	chrome-nickel steel, glas
Number of GN containers:	10 x 1/4 GN
Coolant, amount in kg:	R290 / 0,033
Connected load:	0,194 kW 230 V 50 Hz
Dimensions of glass top (W x D x H), in mm:	1.990 x 330 x 195
Dimensions (W x D x H), in mm:	2.000 x 335 x 459
Weight, in kg:	51,0

The set includes:

- 4 bars, length 181 mm, width 25 mm
- 9 bars, length 264 mm, width 25 mm

EN

Name:	Cooling top GL3-1201
Art. No.:	110275
Material:	chrome-nickel steel, glas
Number of GN containers:	3 x 1/3 GN + 1 x 1/2 GN
Coolant, amount in kg:	R290 / 0,030
Connected load:	0,166 kW 230 V 50 Hz
Dimensions of glass top (W x D x H), in mm:	1.190 x 390 x 195
Dimensions (W x D x H), in mm:	1.200 x 395 x 459
Weight, in kg:	39,0

The set includes:

- 1 bar, length 326 mm, width 45 mm
- 4 bars, length 181 mm, width 25 mm
- 4 bars, length 326 mm, width 25 mm

Name:	Cooling top GL3-1501
Art. No.:	110276
Material:	chrome-nickel steel, glas
Number of GN containers:	5 x 1/3 GN + 1 x 1/2 GN
Coolant, amount in kg:	R290 / 0,030
Connected load:	0,174 kW 230 V 50 Hz
Dimensions of glass top (W x D x H), in mm:	1.490 x 390 x 195
Dimensions (W x D x H), in mm:	1.500 x 395 x 459
Weight, in kg:	45,5

The set includes:

- 1 bar, length 326 mm, width 77 mm
- 4 bars, length 181 mm, width 25 mm
- 6 bars, length 326 mm, width 25 mm

EN

Name:	Cooling top GL3-1801
Art. No.:	110278
Material:	nickel-chrome steel, glass
Number of GN containers:	8 x GN 1/3
Coolant, amount in kg:	R290 / 0,033
Connected load:	0,18 kW 230 V 50 Hz
Dimensions of glass top (W x D x H), in mm:	1.790 x 390 x 195
Dimensions (W x D x H), in mm:	1.800 x 395 x 459
Weight, in kg:	52,0

The set includes:

- 4 bars, length 181 mm, width 25 mm
- 8 bars, length 326 mm, width 25 mm

Name:	Cooling top GL3-2001
Art. No.:	110279
Material:	nickel-chrome steel, glass
Number of GN containers:	9 x GN 1/3
Coolant, amount in kg:	R290 / 0,033
Connected load:	0,194 kW 230 V 50 Hz
Dimensions of glass top (W x D x H), in mm:	1.990 x 390 x 195
Dimensions (W x D x H), in mm:	2.000 x 395 x 459
Weight, in kg:	55,5

The set includes:

- 4 bars, length 181 mm, width 25 mm
- 9 bars, length 326 mm, width 25 mm
- 1 bar, length 326 mm, width 40 mm

EN

4.2 Functions of the Appliance

Cooling tops may be used for cooling and storing suitable food products in suitable GN containers through a specified period of time.

4.3 List of Components of the Appliance

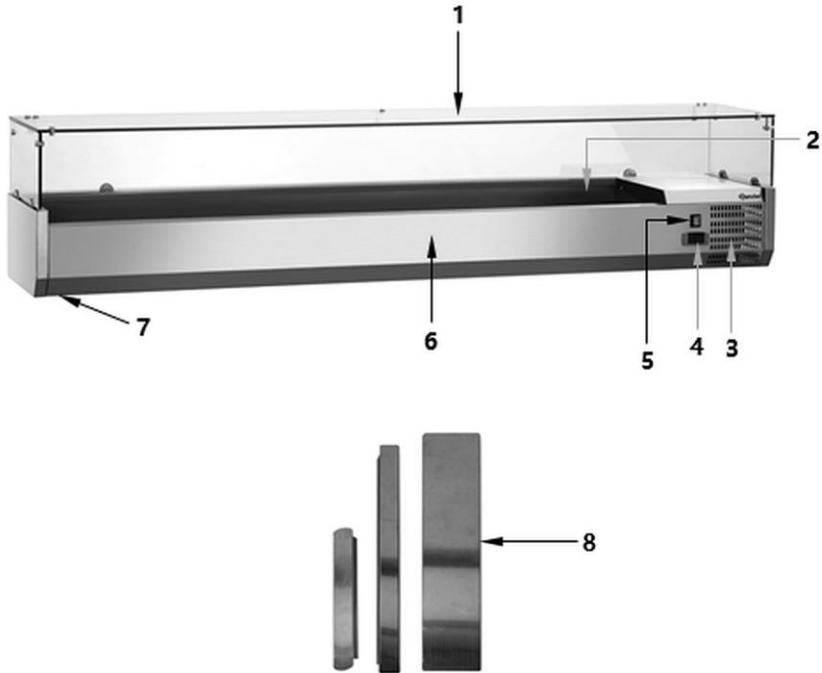

EN

Fig. 1

- | | |
|----------------------------------------------------------------|-----------------------------------|
| 1. Glass top | 2. Cooling tray for GN containers |
| 3. Ventilation openings | 4. Digital temperature controller |
| 5. ON/OFF switch with integrated power indicator light (green) | 6. Housing |
| 7. Feet (4 pcs) | 8. Crossbars |

5 Installation and operation

5.1 Installation



CAUTION!

Incorrect installation, positioning, operation, maintenance or misuse of the appliance may lead to personal injury or property damage.

Positioning and installation, as well as repairs may be performed by authorised technical service only and in compliance with the applicable national law.

Unpacking / Positioning

- Unpack the appliance, remove all external and internal packaging elements and shipment safeguards.



CAUTION!

Choking hazard!

Prevent children from accessing package materials, for instance: plastic bags and EPS.

- If the appliance is covered with a protective film, remove it. Remove the film slowly, so no glue residues are left. Remove any glue residues with the use of a suitable solvent.
- Be careful not to damage the rating plate and warning labels fixed on the appliance.
- **Never** place the appliance in humid or wet environment.
- Place the appliance in a way making the connections easily accessible, so that they may be quickly disconnected if such a need arises.
- The appliance should be placed on surfaces that are:
 - even, with sufficient bearing capacity, resistant to water, dry and resistant to high temperatures;
 - sufficiently large, and thus enabling usage of the appliance with no problems;
 - easily accessible;
 - well ventilated.

Installation and operation

- Maintain sufficient clearance from table edges. The appliance might turn over and fall down.
- Do not place the appliance in direct sunlight or in the vicinity of heat sources (cooker, radiator, heating devices, etc.). Heat sources may negatively affect power consumption, and restrict functions of the appliance, too.
- Place the appliance so that sufficient air circulation is ensured. Do not obstruct nor cover ventilation openings of the appliance.
- Leave at least 10 cm clearance from walls and other objects.
- Leave a sufficient top clearance from shelves so that the stainless steel cover may be freely open. At the front (operator side), leave sufficient space for operating personnel.
- In order to avoid damage to the compressor, do not tilt the appliance more than 45° when positioning or transporting it.
- After setting up the appliance in the designated location, level it with feet, screwing them in or out.

Glass Top Assembly

Glass top of cooling tops GL is disassembled and packed independently. After unpacking, it must be assembled.

First, check the delivered elements for completeness.

Glass top delivery scope (Fig. 2)

Name		Number (pcs)	Name		Number (pcs)
1	Clamps for glass elements	6	7	Right glass pane	1
2	Screws for clamps for glass elements	12	8	Angle section for glass panes	7
3	Grub screws	6	9	Socket head cap screws	14
4	Left glass pane	1	10	Rubber rings	14
5	Top glass pane	1	11	Locking screws	14
6	Rear glass pane	1	12	Glass top housing	1

NOTE!

We recommend to have the glass top assembled by 2 persons!

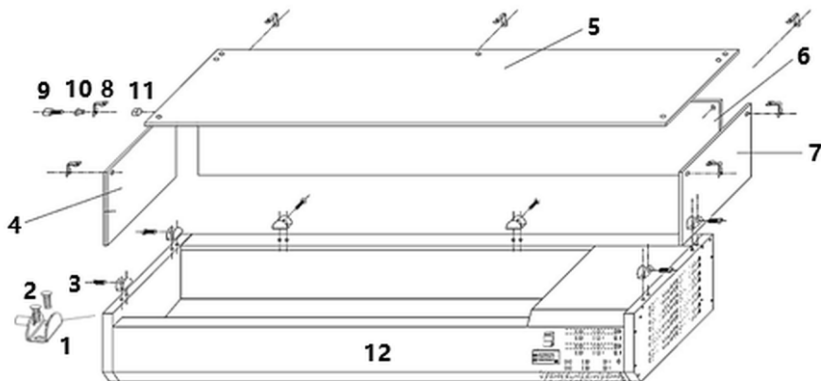

Fig. 2

EN

1. Start the assembly with fixing clamps for glass elements (1) (2 at the right, left and rear) to the housing of the stackable refrigerated display. Use the enclosed screws for clamps for glass elements (2).
2. Insert the left (4), right (7) and rear (6) glass pane in the fixed clamps for glass elements (1).
3. Then, tighten manually grub screws (3) of the clamps for glass elements. **Do not overtighten, for the glass pane may crack!**
4. Fix 2 angle sections (8) in corners of the left (4), right (7) and rear (6) glass pane as well as 1 angle section (8) in the middle of the rear glass pane, using the enclosed socket head cap screws (9), rubber rings (10) and locking screws (11).
5. Then place the top glass pane (5) on the right (7), left (4) and rear glass pane (6) and screw it to the right, left and rear angle section.
6. To end with, check if all glass panes are correctly fitted.

Power supply connection

- Verify if technical data of the appliance (see rating plate) correspond with the local electric power grid specification.
- Connect the appliance to a single, properly grounded mains socket with protective contact. Do not connect the appliance to a multi-socket.
- The power cord should be laid in a way preventing anyone from threading on it or tripping against it.
- Prior to first use, the appliance should be installed and left standing upright for at least 2 hours, before it is connected to power supply.
- After a power failure or when the plug is removed from the socket, do not reconnect the appliance to power supply for at least 5 minutes.

5.2 Operation

Indications for the User

- Fill the cooling top only when the display shows that the required temperature has been reached.
- The prepared food products must be placed only in suitable GN containers (section '**Technical Data**').
- Do not place any warm dishes in the cooling top; cool them down to ambient temperature first.
- Place GN containers filled with food products into the designated cooling tray. If needed, use the enclosed bars as supports for GN containers.
- To avoid occurrence of unpleasant odours in the cooling top follow the recommended storage periods of food products.
- If condensed water collects at the bottom of the cooling tray, wipe it with a soft, dry cloth.
- After a power failure or when the plug is removed from the socket, do not reconnect the appliance to power supply for at least 5 minutes.

Appliance Preparation and Start-Up

1. Before use, clean the cooling top thoroughly, following indications in section 6 '**Cleaning and Maintenance**'.
2. Switch the appliance on (without food products). Follow indication in the subsequent sections of the instruction.
3. Plug the appliance into a suitable single socket.
4. Switch the appliance on by setting the switch at the front of the appliance in '**I**' (ON) position.

The green power indicator light in the ON/OFF switch lights up.



The digital display shows current temperature inside the appliance.

5. No sooner than the appliance reaches the required temperature, may you place food products into the cooling tray of the appliance; food products must be in suitable GN containers.

Control elements and displayed messages







EN

Button	Functions
SET	Showing the set value, selection of parameters in the programming mode or confirmation of the process
	Manual starting of the defrosting
	Selection of the parameter code in the programming mode, increase of the displayed value
 AUX	Selection of the parameter code in the programming mode, decrease of the displayed value

LED indicators

The LED indicators in the digital display show the status of the active function:



LED	Status of the active function	Meaning
	illuminates	activated compressor
	flashes	in delay
	illuminates	defrosting in progress
	flashes	defrosting delay
	illuminates	fan activated
	flashes	delay after defrosting
	illuminates	degrees Celsius temperature unit indicator
	flashes	in the programming mode
	illuminates	degrees Fahrenheit temperature unit indicator
	flashes	in the programming mode



Displaying the set value

1. Press the **SET** button shortly, to display the set value.
2. Press the **SET** button again or wait 5 seconds, to return to the previous message.

Changing the set value (i.e. the required temperature)

1. Press the **SET** button and hold it pressed for at least 3 seconds.

The set value is displayed and the  or  LED indicator flashes on the digital display.

2. The value may be increased or decreased with  or  button until the digital display shows the required value.
3. Confirm the new value with the **SET** button or wait 10 seconds — then, the value will be stored automatically.

Automatic defrosting

The appliance defrosts automatically 4 times over 24-hour period. The timer initiates with the first activation.

1. If there is a need for the change of automatic defrosting phases, press the  button and hold it for more than 2 seconds.

The digital display shows the  symbol.

The defrosting cycle is immediately initiated; in such a case, the subsequent defrosting cycle is executed after 6 hours.

Manual defrosting

Additionally, aside of the automatic defrosting, manual defrosting may be activated any time.

1. Press the  button and hold it pressed for more than 2 seconds.

The manual defrosting is initiated.

The digital display shows the  symbol.

EN

NOTE!

Water generated during defrosting evaporates automatically.

NOTE!

Subsequent settings or parameter changes should be introduced by service personnel only.

Button combinations

Concurrent pressing of two buttons enable activation/deactivation of a number of functions.

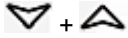

Button locking or unlocking:

- to lock, press both buttons concurrently and hold them pressed for more than 3 seconds, until the digital display shows the "OFF" message
- to unlock, press these buttons and hold them pressed for more than 3 seconds, until the digital display shows the "ON" message

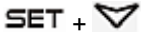

Moving to the programming mode:

- press both buttons concurrently and hold them pressed for more than 3 seconds; when the °C or °F LED indicators flash, subsequent settings may be introduced

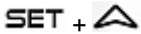

Return to the previously displayed message:

- press these buttons, to leave the programming mode and return to the previously displayed message (value of temperature inside the appliance)

Switching the Appliance Off

1. Switch the appliance off with the ON/OFF switch (set to 'O').
2. After use, disconnect the appliance from the socket (pull the plug out).

6 Cleaning and Maintenance

6.1 Safety Instructions for Cleaning

- Before cleaning, disconnect the appliance from the power supply.
- Leave the appliance to cool down completely.
- Make sure water does not enter the appliance. Do not immerse the appliance in water or other liquids during cleaning. Do not clean the appliance with a pressurized water jet.
- Do not use any sharp or pointed, nor metal implements (knife, fork, etc.). Sharp or pointed implements may damage the appliance, and when in contact with live parts, they may cause electric shock.
- For cleaning, do not use any scouring agents that contain solvents nor corrosive cleaning agents. They may damage the surface.

6.2 Cleaning

1. At the end of a working day, clean the appliance.
2. Remove all objects from the appliance and store them temporarily in a cool room or in a refrigerator, in order for them not to turn.
3. Clean the cooling tray and glass top thoroughly inside and outside with a soft cloth, soaked in suds.
4. Wipe with a clean cloth.
5. Wipe the appliance housing also with a soft, damp cloth. Use a mild cleaning agent if required.
6. Finally, dry thoroughly all washed surfaces.
7. The used accessories (bars, GN containers) should be washed regularly in warm water with a mild cleaning agent. Rinse with clear water. Dry the washed accessories thoroughly with a soft cloth.
8. Regularly remove dust and fibres from ventilation openings of the appliance with a soft brush or dust brush.

EN

6.3 Maintenance

The following operations should be regularly performed by a qualified specialist, to provide for prolonged operation of the refrigerating unit:

1. Cleaning the condenser (weekly):
 - It is possible to access the condenser only after screwing out the cover with the use of special tools.
 - Clean with a vacuum cleaner or a brush with soft hair, moving lightly over ribs of the condenser.

NOTE!

Avoid using hard objects or metal implements, which might damage condenser ribs.

- After cleaning, re-fit the removed cover.
2. Checking of electrical connections.
 3. Checking of correct operation of temperature sensor and temperature controller.

7 Possible Malfunctions

The table below contains descriptions of possible causes and solutions to malfunctions or errors during operation of the appliance. When malfunction cannot be removed, contact the technical service.

In such a case, provide article number, model name and serial number. These data may be found in the rating plate.

Error	Possible Cause	Solution
No cooling	Plug improperly inserted into socket.	Remove the plug and insert it properly in the socket
	Electric power supply safety fuse damaged	Check the fuse, connect the appliance to another socket
	No power supply	Check the electric power supply
	Damaged temperature controller	Contact the service company
Insufficient cooling efficiency	Direct sunlight or heat sources in immediate vicinity	Move the appliance away from heat sources
	Poor air circulation around the appliance	Keep sufficient clearance from walls or other objects
	The products placed inside the appliance are too hot.	Leave food products to cool down before you place them inside the appliance
	Condenser obstructed with dust	Clean the condenser thoroughly

Error	Possible Cause	Solution
Refrigeration unit does not turn off	Damaged temperature sensor	Contact the service company
	Damaged temperature controller	Contact the service company
Strange or loud noises	The appliance is not placed on even surface	Place the appliance on an even surface, use feet to level it
	Appliance touches walls or other objects	Keep sufficient clearance from walls or other objects

8 Disposal

Electrical Appliance



Electric appliances are marked with this symbol. Electrical appliances must be disposed of and recycled in a correct and environmentally friendly manner. You must not dispose of electric appliances with household waste. Disconnect the appliance from the power supply and remove power cord from the appliance.

EN

Electrical appliances should be returned to designated collection points.

Coolant

The propellant used in the appliance is flammable. It should be utilised pursuant to national regulations in force.