

IW10-EB



114367

Bartscher GmbH
Franz-Kleine-Str. 28
D-33154 Salzkotten
Germany

Phone: +49 5258 971-0

Fax: +49 5258 971-120

Technical Support Hotline: +49 5258 971-197

www.bartscher.com



Version: 2.0

Date of preparation: 2023-06-26

Original instruction manual

1	Safety	2
1.1	Explanation of Signal Words	2
1.2	Safety instructions.....	3
1.3	Intended Use	6
1.4	Unintended Use	6
2	General information	7
2.1	Liability and Warranty	7
2.2	Copyright Protection	7
2.3	Declaration of Conformity	7
3	Transport, Packaging and Storage	8
3.1	Delivery Check.....	8
3.2	Packaging	8
3.3	Storage	8
4	Technical Data.....	9
4.1	Technical Specifications	9
4.2	List of Components of the Appliance	10
4.3	Functions of the Appliance.....	10
5	Installation and operation	11
5.1	Installation.....	11
5.2	Operation	13
6	Cleaning	16
6.1	Safety Instructions for Cleaning	16
6.2	Cleaning.....	16
7	Possible Malfunctions.....	17
8	Disposal.....	18



Read this instruction manual before using and keep it available at all times!

This instruction manual contains information about installation, operation and maintenance of the appliance and constitutes an important source of information and reference guide. The knowledge of all operational and safety instructions included in this manual is a prerequisite for safe and proper handling of the appliance. Additionally, accident prevention, occupational health and safety, and legal regulations in force in the area the appliance is used apply.

Before you start using the appliance, especially before turning it on, read this instruction manual in order to avoid personal injuries and property damages. Improper use may cause damage.

This instruction manual forms an integral part of the product and must be stored in an immediate vicinity of the appliance and be available at all times. The instruction manual should be transferred together with the appliance.

1 Safety

This appliance has been manufactured in accordance with technical standards currently in force. However, the appliance may be a source of hazards if used improperly or contrary to its intended purpose. All persons using the appliance must consider information included in this instruction manual and observe safety instructions.

1.1 Explanation of Signal Words

Important safety instructions and warning information are indicated in this instruction manual with appropriate signal words. You must strictly follow the instructions, to prevent accidents, personal injuries and property damages.



DANGER!

The signal word **DANGER** warns against hazards that lead to severe injuries or death if the hazards are not avoided.



WARNING!

The signal word **WARNING** warns against hazards that may lead to moderate or severe injuries or death if the hazards are not avoided.



CAUTION!

The signal word **CAUTION** warns against hazards that may lead to light or moderate injuries if the hazards are not avoided.

IMPORTANT!

The signal word **IMPORTANT** indicates possible property damages, which may occur if safety instructions are not observed.

NOTE!

The symbol **NOTE** indicates subsequent information and guidelines for the user on usage of the appliance.

1.2 Safety instructions

Electrical Current

- Too high a mains voltage or incorrect installation may cause electric shock.
- The appliance may be connected only if data on the rating plate correspond with the mains voltage.
- To avoid short-circuit, the appliance should be kept dry.
- If there are malfunctions during operation, disconnect the appliance from the power supply.
- Do not touch the appliance's plug with wet hands.
- Never take hold of the appliance if it has fallen into water. Immediately disconnect the appliance from the power supply.
- Any repairs or housing opening may be carried out by professionals and relevant workshops only.
- Do not transport the appliance, holding it by the power cord.
- Do not allow the power cord to come into contact with heat sources or sharp edges.
- Do not bend, pinch nor knot the power cord.

- Always completely unwind the power cord.
- Never place the appliance or other objects on the power cord.
- Always take hold of the plug to disconnect the appliance from the power supply.
- Check the power cord regularly for damage. Do not use the appliance if the power cord is damaged. If this cable is damaged, it must be replaced by customer service or a qualified electrician in order to avoid dangers.

Flammable Materials

- Never subject the appliance to contact with high temperature sources, e.g.: oven, furnace, open flame, heat generating devices, etc.
- To avoid fire hazard, clean the appliance regularly.
- Do not cover the appliance with, e.g., aluminium foil or cloths.
- Use the appliance only with materials designated to this end and with correct temperature settings. Materials, groceries and left-overs remaining in the appliance may catch fire.
- Never use the appliance near flammable or inflammable materials, e.g.: petrol, spirit, alcohol, etc. High temperature triggers evaporation of these materials, and, as a result of contact with sources of ignition, an explosion may occur.
- In case of fire, disconnect the appliance from the power supply before attempting suitable fire-extinguishing actions.
- Never attempt to extinguish fire with water if the appliance is connected to the power supply. Following extinction of fire, ensure sufficient fresh air inflow.

EN

Electromagnetic Fields

- Magnetized items, e.g. credit cards, data storage devices or calculators, may not be placed in an immediate vicinity of the switched on appliance. Magnetic field might damage them.
- Do not open the bottom cover!
- Cookware should always be placed in the middle of the cooking area, so that pot bottom covered the electromagnetic field to the maximum extent.
- Scientific researches proved that induction cookers pose no threat. Nevertheless, people with cardiac pacemaker should keep a distance of at least 60 cm from the working appliance.

Safety of Induction Plate Operation

- During operation, the heating area is getting very hot.

Information: Induction cooker does not generate heat in the process of cooking. Nevertheless, the temperature of cookware heats up the heating

Safety

area and the surface remains hot after use. Do not touch any hot surfaces of the appliance.

- You may transport and clean the appliance after it cools down entirely.
- It is prohibited to sprinkle hot surfaces with cold water or flammable liquids.
- Do not put metal kitchen utensils, lids, knives nor any other metal objects on the heating area. These objects might heat up after switching the appliance on.
- Remember that wearable items, e.g. rings, watches etc., may heat up when they are close to the cooker's plate.
- In order to avoid overheating, do not place any aluminium foil or metal plates on the heating surface of the appliance.
- Do not heat up sealed containers, e.g. canned food, on the heating area of the induction cooker. Resulting overpressure may cause explosion (rupture) of a container or a can. The canned food is best to open it, put it in a pot filled with water and place the pot on a heating area in order to heat it up.
- The heating area is made of a temperature-resistant glass. In case of damage, even if it is only a small fracture, the device should be immediately disconnected from the power supply and you should contact the service company.

Operating personnel

EN

- The appliance can be used by children of 8 years old and older, as well as by people with reduced physical, sensory or mental abilities and those with limited experience/knowledge as long as they are under supervision or have been instructed on safe use of the appliance and possible risks. Children should not play with the appliance.
- Do not leave the appliance unattended in the presence of children.
- Cleaning and user maintenance may not be performed by children.
- Children that are 8 or younger may not get close to the appliance nor the power cord.

Improper Use

- Unintended or prohibited use may cause damage to the appliance.
- The appliance may only be used when its technical condition is flawless and allows for safe operation.
- The appliance may only be used when all connections are executed according to rules of law in force.
- The appliance may only be used when it is clean.
- Use only original spare parts. Never attempt to repair the appliance on your own.

- Do not introduce any changes in the appliance nor modify it.

1.3 Intended Use

As described below, every use of the appliance for a purpose differing and/or diverging from its intended standard use, is prohibited and considered to be an unintended use.

The following is an intended use:

- Preparing or heating up food.

1.4 Unintended Use

An unintended use may lead to personal injuries or property damages caused by hazardous voltage, fire or high temperature. The appliance may only be used to perform tasks described in this instruction manual.

The following is an unintended use:

- Heating-up flammable, hazardous to health and volatile, etc. liquids and materials.

2 General information

2.1 Liability and Warranty

All information and instructions in this instruction manual account for legal regulations in force, current level of technical engineering knowledge as well as our expertise and experience, developed over the years. If special models or additional options are ordered, or state-of-the-art technical solutions were implemented, the actual scope of delivery of the appliance may, in some circumstances, differ from descriptions and numerous drawings in this instruction manual.

The manufacturer is not liable for any damages nor faults stemming from:

- failure to observe instructions,
- unintended use,
- technical alterations introduced by the user,
- usage of unapproved spare parts.

We reserve the right to introduce technical modifications to the product, intended for improvement of the appliance and its performance.

2.2 Copyright Protection

This instruction manual, and texts, drawings and images included in it, as well as its other components are copyright protected. It is prohibited to reproduce this instruction manual (including its excerpts), in any form and by any means, and to use and/or transfer its content to third parties without manufacturer's written permission. Violation of the above results in obligation to pay compensation. We reserve the right to claim further damages.

EN

2.3 Declaration of Conformity

The appliance meets the currently applicable standards and guidelines of the European Union. We confirm the above in the EC Declaration of Conformity. We may provide relevant Declaration of Conformity upon request.

3 Transport, Packaging and Storage

3.1 Delivery Check

Immediately upon reception, check the delivery for completeness and possible shipping damage. In the case of visible transport damage refuse to accept the appliance or accept it conditionally. Mark and note the scope of damage in shipping documents/consignment list of the shipping company and lodge a complaint.

Concealed damage must be reported immediately upon its discovery, as compensation claims may only be filed within applicable time limits.

If you find that parts or accessories missing, please contact our Customer Service Department.

3.2 Packaging

Do not dispose of the appliance cardboard box. It may be used to store the appliance when relocating or when shipping the appliance to our service point in the case of any damages.

The packaging and its elements are made of recyclable materials. Particularly, these are: plastic films and bags, cardboard box.

When disposing of the packaging, observe applicable domestic regulations. Recyclable packaging materials should be recycled.

3.3 Storage

Leave the packaging closed until installation of the appliance; observe external indications concerning method of placing and storage. Store the packaging in the following conditions only:

- in closed rooms;
- in dry and dust-free surrounding;
- away from aggressive agents;
- in a location protected against sunlight;
- in a location protected against mechanical shocks.

In the case of extended storage (over three months), make sure you check the condition of the packaging and the parts regularly. If needed, replace the packaging with a new one.

4 Technical Data

4.1 Technical Specifications

Name:	Induction warming plate IW10-EB
Art. No.:	114367
Material:	Stainless steel
Heating plate material:	Glass
Number of heating plates:	1
Max. output, W:	1000
Temperature range, min.–max., in °C:	40 - 100
Number of temperature levels:	13
Temperature setting intervals, in °C:	5
Connected load:	1,0 kW 220-240 V 50/60 Hz
Glass plate dimensions (W x D), in mm:	455 x 310
Dimensions (W x D x H), in mm:	490 x 345 x 67
Weight, in kg:	5,4

We reserve the right to implement technical modifications.

Version / Characteristics

- Type of heating station: induction
- Control: temperature
- Possibility to be built in
- Cookware detection
- Digital display
- Protection against overheating
- ON/OFF button
- Indicator light: ON/OFF
- Control: electronic, touch
- May also be used as a table-top appliance
- 3 appliances may be connected in sequence in 1 power circuit
- Also suitable for square cookware

4.2 List of Components of the Appliance

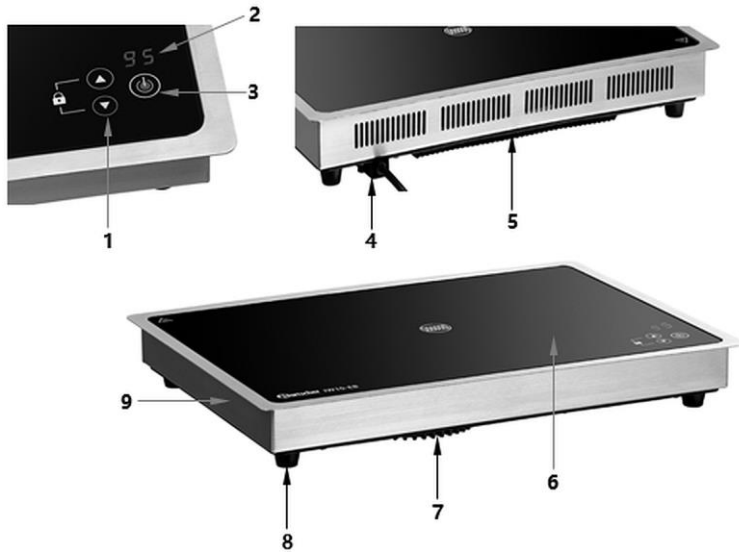

Fig. 1

1. Setting keys with lock function
2. Digital display
3. ON/OFF switch with indicator light
4. Power cord
5. Plastic bottom
6. Plate maintaining temperature
7. Fan
8. Feet (4 pcs)
9. Housing

4.3 Functions of the Appliance

The induction heating plate is intended for keeping food warm using appropriate cookware.

5 Installation and operation

5.1 Installation

Unpacking / Positioning

- Unpack the appliance, remove all external and internal packaging elements and shipment safeguards.



CAUTION!

Choking hazard!

Prevent children from accessing package materials, for instance: plastic bags and EPS.

- If the appliance is covered with a protective film, remove it. Remove the film slowly, so no glue residues are left. Remove any glue residues with the use of a suitable solvent.
- Be careful not to damage the rating plate and warning labels fixed on the appliance.
- **Never** place the appliance in humid or wet environment.
- Place the appliance in a way making the connections easily accessible, so that they may be quickly disconnected if such a need arises.
- The appliance should be placed on surfaces that are:
 - even, with sufficient bearing capacity, resistant to water, dry and resistant to high temperatures;
 - sufficiently large, and thus enabling usage of the appliance with no problems;
 - easily accessible;
 - well ventilated.
- Do not place the appliance in the vicinity of devices or objects that are sensitive to magnetic fields (e.g. radio, television, etc.).
- Leave at least 5 -10 cm clearance from flammable walls and other objects.

Built-in Installation

The appliance are designed to be installed in a work table board. During installation, follow these indications:

1. For installation, select a work table board that is heat resistant to avoid deformation due to the heat radiation of the appliance.
2. Make sure that the thickness of the work table board meets the required load-bearing capacity.
3. Cut the opening in the work table board according to the diagram below.

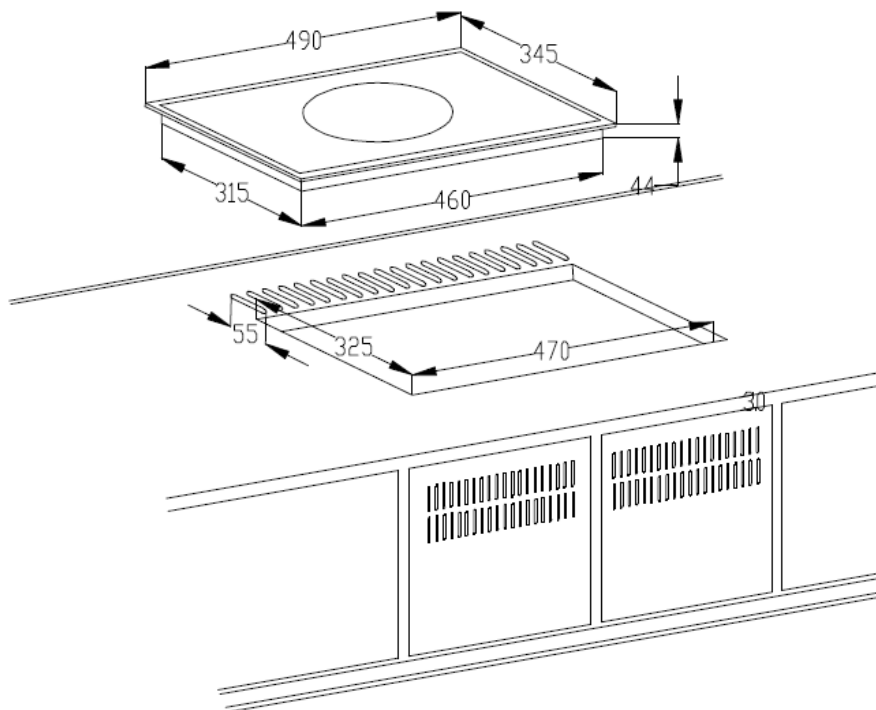

4. Provide sufficient ventilation around the appliance and make sure that the ventilation holes are not obstructed.

NOTE: A safe distance between the heating plate and a cupboard above the device should be at least 760 mm if no extractor hood is provided for.

Power supply connection

- Verify if technical data of the appliance (see rating plate) correspond with the local electric power grid specification.
- Connect the appliance to a single, properly grounded mains socket with protective contact. Do not connect the appliance to a multi-socket.
- The power cord should be laid in a way preventing anyone from threading on it or tripping against it.
- Do not use the appliance with an external timer or remote control.

5.2 Operation

Method of operation of heating plates

In induction cookers the electric voltage is applied to a conductive coil under the glass. This generates magnetic field, which being a physical effect, heats the bottom of a cookware directly.

This translates to savings of time and energy, as — contradictory to traditional heating areas — there is no heating up of a heater and then of the glass heating plate.

Another advantage of the technical features described above is the very short cooking time.

Additionally, inflow of heat changes instantly with every change of settings and it may be controlled precisely. The induction heating plate reacts to changes in settings as fast a gas cooker, for the energy is delivered immediately to a pot, without the need to prior heating up of other materials.

The induction technology combines the speed of reaction with a basic benefit of the current, making it possible to precisely control heat inflow.

Suitable Cookware

- Iron cookware
- Enamelled iron cookware
- Steel or enamelled cast iron pots/pans
- Cast iron pots/pans
- Cookware made of 18/0 stainless steel and aluminium if marked as suitable for induction (mind the description of the cookware)



Due to a specific way the induction plate operates, only cookware/containers with a bottom subject to magnetization are suitable.

To obtain better results, use only cookware/containers with a diameter of >12 cm.

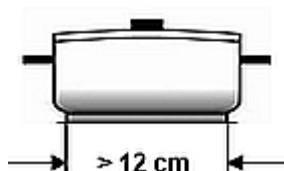

Both circular and square cookware/containers suitable for induction plates may be used to keep food warm on the IW10-EB induction heating plate.

EN

Not Suitable Cookware

- Containers with bulged bottoms
- Aluminium, brass, copper cookware unless they are clearly indicated as suitable for induction
- Pots/pans with a diameter below 12 cm
- Cookware with feet
- Ceramic cookware
- Glass cookware



Before Use

1. Before use, clean the appliance according to the indications provided in section 6. 'Cleaning'.
2. Place a suitable container with contents on the heat-retaining surface.

ATTENTION!

Do not leave an empty cookware on the heating plate, as this may lead to damage to the appliance.

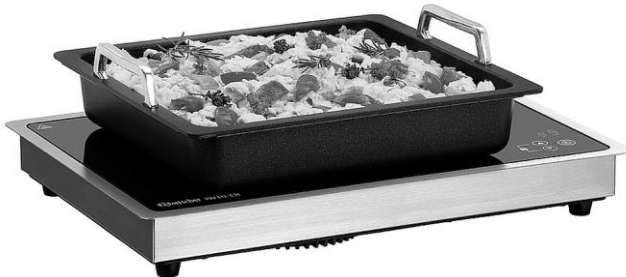





Fig. 2

Appliance Start-Up

1. Plug the appliance into a suitable single socket.
 2. To switch the appliance on, press the ON/OFF switch  on the control panel. The indicator light lights up.
- '- - '. appears on the digital display.

NOTE!

If the appliance is emitting a sound signal, the used cookware is not suitable for induction or the appliance is damaged.

3. Use the  or  setting keys to set the temperature in the range of 40–100°C, in 5°C increments.

The set temperature will be shown in the digital display.

NOTE!

To prevent the settings from being changed by accidentally touching the setting keys, activate the key lock.

To do this, press the settings and  and  keys simultaneously.

To cancel the key lock, press these keys again.

Switching Appliance OFF

1. When the intended effect is obtained or when the appliance will not be used any more, switch it off with the ON/OFF switch.

6 Cleaning

6.1 Safety Instructions for Cleaning

- Before cleaning, disconnect the appliance from the power supply.
- Leave the appliance to cool down completely.
- Make sure water does not enter the appliance. Do not immerse the appliance in water or other liquids during cleaning. Do not clean the appliance with a pressurized water jet.
- Do not use any sharp or pointed, nor metal implements (knife, fork, etc.). Sharp or pointed implements may damage the appliance, and when in contact with live parts, they may cause electric shock.
- For cleaning, do not use any scouring agents that contain solvents nor corrosive cleaning agents. They may damage the surface.

6.2 Cleaning

1. Clean the appliance regularly after end of each working day, or more frequently if needed.
2. Wipe the heating plate and the housing with a soft, damp cloth and a mild, non-scrubbing washing agent.
3. Wipe all washed surfaces with a clean cloth.
4. Dry the appliance with a soft, lint-free cloth.

7 Possible Malfunctions

The table below contains descriptions of possible causes and solutions to malfunctions or errors during operation of the appliance. When malfunction cannot be removed, contact the technical service.

In such a case, provide article number, model name and serial number. These data may be found in the rating plate.

Error code	Cause	Solution
E0	No cookware or not suitable cookware.	Place an appropriate cookware / container with food on the heating plate.
E1	The internal temperature of the induction heating plate is too high or the internal fan does not work.	Maintain at least 10 cm clearance between the ventilation slot and walls or other devices. Pull the plug out. Wait for the appliance to cool off. After cooling off, switch the appliance on as usual. Check and clean the air inlet and the valve, provided they are obstructed.
E2	Temperature of a cookware is too high. Overheating protection was triggered.	Remove the cookware from the heating plate. Wait for the appliance to cool off.
E3	Input voltage is too high or too low.	Make sure that the device is connected to the right input voltage.

8 Disposal

Electrical Appliance

	<p>Electric appliances are marked with this symbol. Electrical appliances must be disposed of and recycled in a correct and environmentally friendly manner. You must not dispose of electric appliances with household waste. Disconnect the appliance from the power supply and remove power cord from the appliance.</p>
---	---

Electrical appliances should be returned to designated collection points.