

TT160



300083

PRODUCT DESCRIPTION

- Name: • **Tray transport trolley TT160**
- Code-No.: • **300083**
- Material: • Chrome nickel steel
- Realization: • 4 rubber swivel wheels, Ø 125 mm,
2 swivel wheels with brakes,
Shelf with railing: W 775 x D 530 x H 150 mm
one-way handle for easy moving
- Slots: • can hold up to 16 trays,
2 x 8 slots 500 x 360 mm,
suitable for GN 1/1 trays
or standard table trays 443 x 343 mm
- Dimensions: • W 925 x D 620 x H 1700 mm
- Carrying capacity: • total 48 kg, maximum load per slot: 3.0 kg
- Space between slots: • 145 mm
- Weight: • 38.0 kg
-

We reserve the right to make technical changes!

Contents of delivery /description

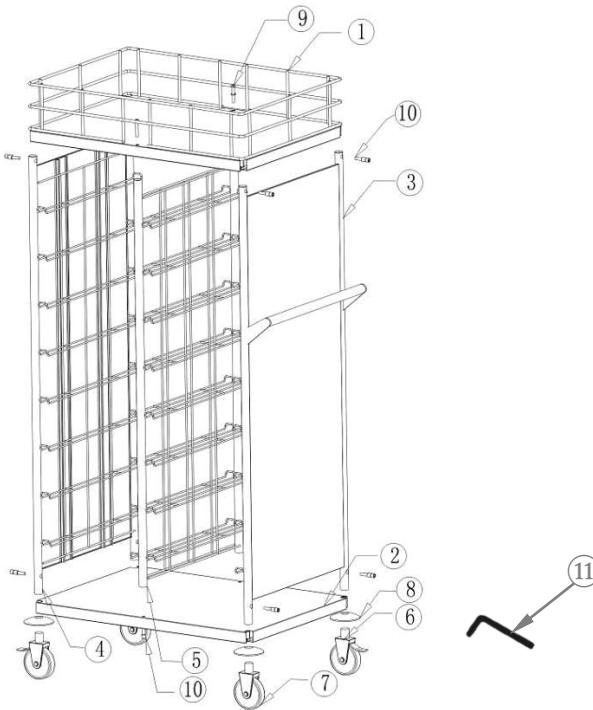

①	1 x upper shelf with railing	⑦	2 x swivel wheels without brake, Ø 125 mm
②	1 x lower shelf	⑧	4 x swivel wheel bumpers
③	1 x side with handle and mounted tray slots	⑨	2 x screws M8x50
④	1 x side with mounted tray slots	⑩	10 x screws M8x40
⑤	1 x openwork wall with mounted tray slots on both sides	⑪	2 x wrench
⑥	2 x swivel wheels with brake, Ø 125 mm		

Assembly

1. First, unpack each individual part and ensure that everything is present in the delivery. Recycle all packing material.
2. Assemble the transport trolley based on the instructions presented below. Use the included wrench for best results.

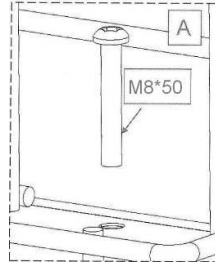
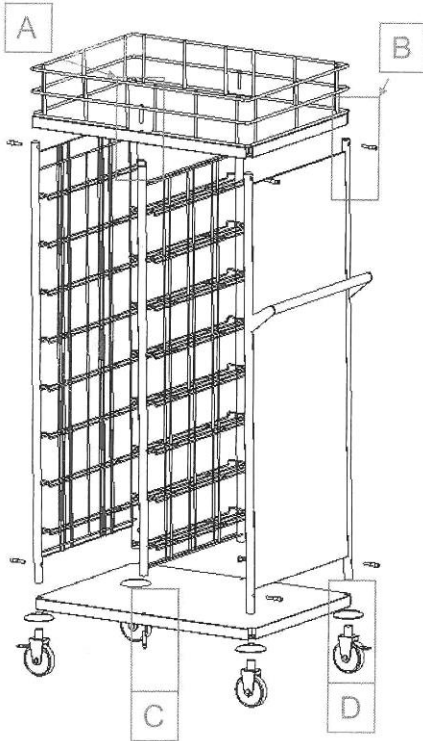

3. Begin by fixing the upper shelf with railing to the openwork wall. Lay the shelf with railing on its side and screw it into the openwork wall with 2 screws M8x50 (**dia. A**).

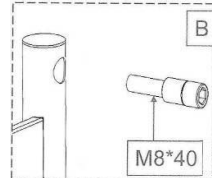

4. Place the side elements in the corners of the shelf with railing, then screw the side elements into the upper shelf with railing using M8x40 screws (**dia. B**).

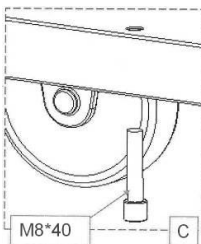

5. Place the side elements in the corners of the lower shelf, then screw the lower shelf into the openwork wall followed by the side elements. Use the M8x40 screws included (**dia. C**).

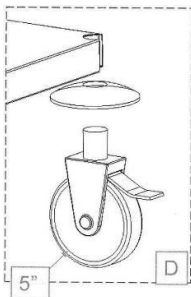

6. Place the wheel bumpers over the swivel wheels and fix them to the side, screwing the swivel wheels into the side element supports (**dia. D**). The wheels with brake should be mounted on opposite corners.
7. Place the tray transport trolley on its wheels and check its stability.
8. The tray transport trolley can be made level by screwing in/unscrewing the swivel wheels.

Tips for the user

- Trays can be inserted from either side. Place the standard table trays or GN 1/1 on the railings.
- To transport the tray transport trolley, use the handle at the side.
- When the tray transport trolley is in the desired location, activate the brakes to prevent it from being accidentally moved.
- Clean the tray transport trolley with a soft, moist cloth. Do not use abrasive cleaning substances that could damage the tray transport trolley's surface.

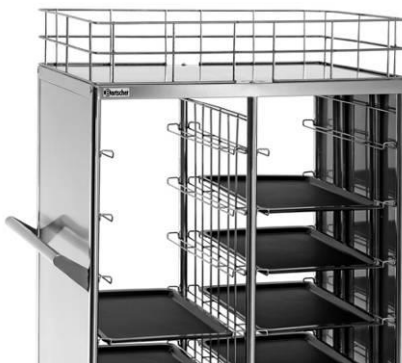

Bartscher GmbH
Franz-Kleine-Str. 28
33154 Salzkotten
Germany

phone: +49 5258 971-0
fax: +49 5258 971-120
Service-Hotline: +49 5258 971-197
www.bartscher.com