

Kids K4110-150U / 150W / 150A



125540-125540V1-125540V2

Bartscher GmbH
Franz-Kleine-Str. 28
D-33154 Salzkotten
Germany

Phone: +49 5258 971-0

Fax: +49 5258 971-120

Technical Support Hotline: +49 5258 971-197

www.bartscher.com



Version: 1.0

Date of preparation: 2021-10-01

Original instruction manual

1	Safety	2
1.1	Explanation of Signal Words.....	2
1.2	Safety instructions.....	3
1.3	Intended Use	6
1.4	Unintended Use	6
2	General information	7
2.1	Liability and Warranty	7
2.2	Copyright Protection	7
2.3	Declaration of Conformity	7
3	Transport, Packaging and Storage	8
3.1	Delivery Check.....	8
3.2	Packaging	8
3.3	Storage	8
4	Technical Data.....	9
4.1	Technical Specifications	9
4.2	Functions of the Appliance.....	10
4.3	List of Components of the Appliance	11
5	Installation and operation	12
5.1	Installation.....	12
5.2	Operation	14
6	Cleaning	21
6.1	Safety Instructions for Cleaning	21
6.2	Cleaning.....	21
7	Disposal.....	22



Read this instruction manual before using and keep it available at all times!

This instruction manual contains information about installation, operation and maintenance of the appliance and constitutes an important source of information and reference guide. The knowledge of all operational and safety instructions included in this manual is a prerequisite for safe and proper handling of the appliance. Additionally, accident prevention, occupational health and safety, and legal regulations in force in the area the appliance is used apply.

Before you start using the appliance, especially before turning it on, read this instruction manual in order to avoid personal injuries and property damages. Improper use may cause damage.

This instruction manual forms an integral part of the product and must be stored in an immediate vicinity of the appliance and be available at all times. The instruction manual should be transferred together with the appliance.

1 Safety

EN

This appliance has been manufactured in accordance with technical standards currently in force. However, the appliance may be a source of hazards if used improperly or contrary to its intended purpose. All persons using the appliance must consider information included in this instruction manual and observe safety instructions.

1.1 Explanation of Signal Words

Important safety instructions and warning information are indicated in this instruction manual with appropriate signal words. You must strictly follow the instructions, to prevent accidents, personal injuries and property damages.



DANGER!

The signal word **DANGER** warns against hazards that lead to severe injuries or death if the hazards are not avoided.



WARNING!

The signal word **WARNING** warns against hazards that may lead to moderate or severe injuries or death if the hazards are not avoided.



CAUTION!

The signal word **CAUTION** warns against hazards that may lead to light or moderate injuries if the hazards are not avoided.

IMPORTANT!

The signal word **IMPORTANT** indicates possible property damages, which may occur if safety instructions are not observed.

NOTE!

The symbol **NOTE** indicates subsequent information and guidelines for the user on usage of the appliance.

1.2 Safety instructions

Electrical Current

- Too high a mains voltage or incorrect installation may cause electric shock.
- The appliance may be connected only if data on the rating plate correspond with the mains voltage.
- To avoid short-circuit, the appliance should be kept dry.
- If there are malfunctions during operation, disconnect the appliance from the power supply.
- Do not touch the appliance's plug with wet hands.
- Never take hold of the appliance if it has fallen into water. Immediately disconnect the appliance from the power supply.
- Any repairs or housing opening may be carried out by professionals and relevant workshops only.
- Do not transport the appliance, holding it by the power cord.
- Do not allow the power cord to come into contact with heat sources or sharp edges.
- Do not bend, pinch nor knot the power cord.

- Always completely unwind the power cord.
- Never place the appliance or other objects on the power cord.
- Always take hold of the plug to disconnect the appliance from the power supply.
- Check the power cord regularly for damage. Do not use the appliance if the power cord is damaged. If this cable is damaged, it must be replaced by customer service or a qualified electrician in order to avoid dangers.

Fire hazard / flammable materials hazard / explosion hazard!

- Do not use any electric devices in the appliance.
- Do not store nor use petrol or other flammable liquids and gases in the vicinity of this or any other appliance. Those gases may cause fire or explosion hazard.
- Do not put into the appliance any explosive materials, like sprays filled with flammable propellants. Contents of containers filled with flammable gases and liquids may leak in low temperatures, and the contents may catch fire from sparks generated by an electric appliance. Explosion hazard!
- In the case of coolant leakage, pull the plug from the socket. Remove all sources of ignition in the vicinity, ventilate room and contact technical service. Avoid coolant getting in contact with eyes, as it may cause serious eye damage.
- Never use any flammable liquids for cleaning the appliance or its parts. Gases released may cause fire or explosion hazard.
- In the case of fire, disconnect the appliance from the power supply before attempting adequate fire-extinguishing actions.
- Never attempt to extinguish fire with water if the appliance is connected to the power supply. Following extinction of fire, ensure sufficient fresh air inflow.
- Defrosting process may not be sped up with mechanical means or heat energy sources (candles or heaters) nor with any other means. Vapour produced may cause short-circuit and too high temperatures may damage the appliance.
- All ventilation slots should not be obstructed during operation.
- Never attempt to damage cooling installation of the appliance.

Operating personnel

- This appliance is not intended to be used by persons (including children) with limited physical, sensory or mental capabilities, nor by persons with limited experience and/or limited knowledge.
- Children should be supervised to ensure that they are not playing with or switching the appliance on.

Children may only take dishes or food products from the device!

Improper Use

- Unintended or prohibited use may cause damage to the appliance.
- The appliance may only be used when its technical condition is flawless and allows for safe operation.
- The appliance may only be used when all connections are executed according to rules of law in force.
- The appliance may only be used when it is clean.
- Use only original spare parts. Never attempt to repair the appliance on your own.
- Do not introduce any changes in the appliance nor modify it.

- Do not drill hole in the appliance nor install any objects on it.
- Do not place any heavy objects on the appliance.

1.3 Intended Use

As described below, every use of the appliance for a purpose differing and/or diverging from its intended standard use, is prohibited and considered to be an unintended use.

The following is an intended use:

- Cooling food products in suitable GN containers.

1.4 Unintended Use

An unintended use may lead to personal injuries or property damages caused by hazardous voltage, fire or high temperature. The appliance may only be used to perform tasks described in this instruction manual.

The following is an unintended use:

- Cooling of not suitable food products.
- Storing flammable or explosive objects and liquids, such as ether, petroleum or adhesives;
- Storing explosive materials, like sprays filled with flammable propellants;
- Storing pharmaceutical products or preserved blood.

2 General information

2.1 Liability and Warranty

All information and instructions in this instruction manual account for legal regulations in force, current level of technical engineering knowledge as well as our expertise and experience, developed over the years. If special models or additional options are ordered, or state-of-the-art technical solutions were implemented, the actual scope of delivery of the appliance may, in some circumstances, differ from descriptions and numerous drawings in this instruction manual.

The manufacturer is not liable for any damages nor faults stemming from:

- failure to observe instructions,
- unintended use,
- technical alterations introduced by the user,
- usage of unapproved spare parts.

We reserve the right to introduce technical modifications to the product, intended for improvement of the appliance and its performance.

2.2 Copyright Protection

This instruction manual, and texts, drawings and images included in it, as well as its other components are copyright protected. It is prohibited to reproduce this instruction manual (including its excerpts), in any form and by any means, and to use and/or transfer its content to third parties without manufacturer's written permission. Violation of the above results in obligation to pay compensation. We reserve the right to claim further damages.

EN

2.3 Declaration of Conformity

The appliance meets the currently applicable standards and guidelines of the European Union. We confirm the above in the EC Declaration of Conformity. We may provide relevant Declaration of Conformity upon request.

3 Transport, Packaging and Storage

3.1 Delivery Check

Immediately upon reception, check the delivery for completeness and possible shipping damage. In the case of visible transport damage refuse to accept the appliance or accept it conditionally. Mark and note the scope of damage in shipping documents/consignment list of the shipping company and lodge a complaint. Concealed damage must be reported immediately upon its discovery, as compensation claims may only be filed within applicable time limits.

If you find that parts or accessories missing, please contact our Customer Service Department.

3.2 Packaging

Do not dispose of the appliance cardboard box. It may be used to store the appliance when relocating or when shipping the appliance to our service point in the case of any damages.

The packaging and its elements are made of recyclable materials. Particularly, these are: plastic films and bags, cardboard box.

EN

When disposing of the packaging, observe applicable domestic regulations. Recyclable packaging materials should be recycled.

3.3 Storage

Leave the packaging closed until installation of the appliance; observe external indications concerning method of placing and storage. Store the packaging in the following conditions only:

- in closed rooms;
- in dry and dust-free surrounding;
- away from aggressive agents;
- in a location protected against sunlight;
- in a location protected against mechanical shocks.

In the case of extended storage (over three months), make sure you check the condition of the packaging and the parts regularly. If needed, replace the packaging with a new one.

4 Technical Data

4.1 Technical Specifications

Version / properties of the Kids buffet cart

- Cooling: static
- Folding tray slide shelf
- Sneeze guard
- Lighting:
 - LED
 - it turns on when the mains plug is inserted
- Drain tap
- checking of power cord;
 - spiral cable
 - cord length: 1 m
- Swivel castors: 5 swivel castors, 2 with brakes
- Indicator light: ON/OFF
- State at delivery: assembled for ready to use
- Features:
 - stainless steel basins
 - rounded edges
- The set includes: 4 bars, length 528 mm, width 30 mm
- The set does not include: GN containers

We reserve the right to implement technical modifications.

Name:	Buffet trolley Kids K4110-150U / 150W / 150A
Art. No.:	125540-125540V1-125540V2
Material:	laminated wood / stainless steel / plastic
Colour:	elm / wenge / anthracite
Number of slits:	1
Basin size, GN format	4 x 1/1 GN
Max. GN container depth, in mm:	150
Temperature range, min.–max., in °C:	2 - 4
Climate class:	3
Coolant, amount in kg:	R290 / 0,06
Serving height, in mm:	700
Dimensions of the shelf for moving trays (W x D), in mm:	1.460 x 250
Number of bars:	4
Bar dimensions (W x D), in mm:	528 x 30
Power supply:	0,349 kW 230 V 50 Hz
Dimensions (W x D x H), in mm:	1.460 x 1.160 x 1.215
Weight, in kg:	118,0

EN

4.2 Functions of the Appliance

The buffet cart is designed for displaying and serving cooled food products. Thanks to the appropriate height of service, children can also enjoy the possibility of self-service and the choice of perfectly chilled food.

4.3 List of Components of the Appliance

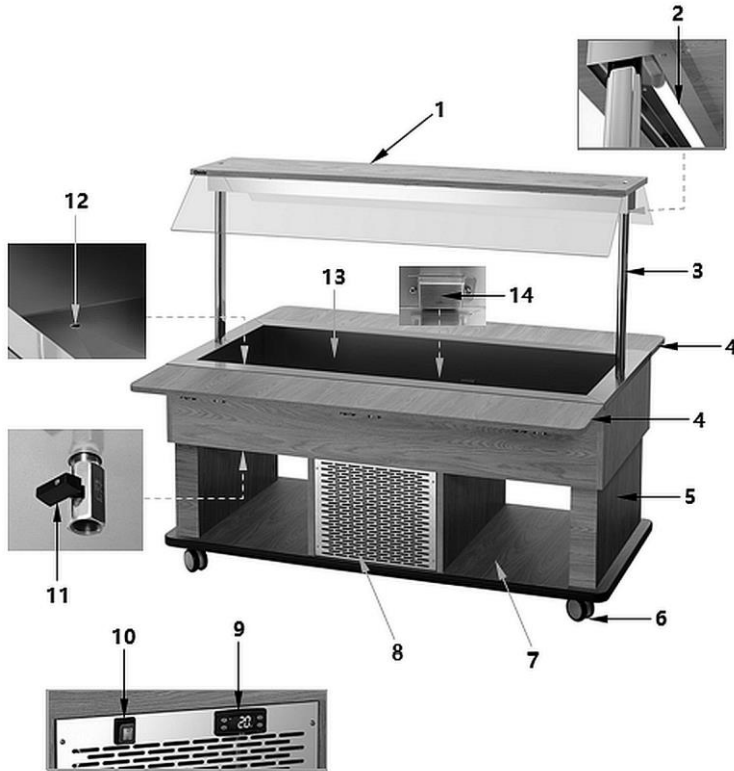

Fig. 1

- | | |
|------------------------------------|---|
| 1. Sneeze guard | 2. LED lighting |
| 3. Hygienic cover bracket | 4. Shelves for moving trays (2 pcs.) |
| 5. Body | 6. Swivel castors (5 pcs, 2 with brakes) |
| 7. Bottom working surface | 8. Ventilation openings |
| 9. Digital temperature controller | 10. ON/OFF switch with integrated power indicator light (green) |
| 11. Drain tap | 12. Cooling tub drain |
| 13. Cooling tray for GN containers | 14. Temperature sensor cover |

EN

5 Installation and operation

5.1 Installation



CAUTION!

Incorrect installation, positioning, operation, maintenance or misuse of the appliance may lead to personal injury or property damage.

Positioning and installation, as well as repairs may be performed by authorised technical service only and in compliance with the applicable national law.

Unpacking / Positioning

- Unpack the appliance, remove all external and internal packaging elements and shipment safeguards.



CAUTION!

Choking hazard!

Prevent children from accessing package materials, for instance: plastic bags and EPS.

- If the appliance is covered with a protective film, remove it. Remove the film slowly, so no glue residues are left. Remove any glue residues with the use of a suitable solvent.
- Be careful not to damage the rating plate and warning labels fixed on the appliance.
- **Never** place the appliance in humid or wet environment.
- Place the appliance in a way making the connections easily accessible, so that they may be quickly disconnected if such a need arises.
- The appliance should be placed on surfaces that are:
 - even, with sufficient bearing capacity, resistant to water, dry and resistant to high temperatures;
 - sufficiently large, and thus enabling usage of the appliance with no problems;
 - easily accessible;
 - well ventilated.

Installation and operation

- Do not place the appliance in direct sunlight or in the vicinity of heat sources (cooker, radiator, heating devices, etc.). Heat sources may negatively affect power consumption, and restrict functions of the appliance, too.
- Place the appliance so that sufficient air circulation is ensured. Do not block nor cover ventilation openings in the rear wall of the appliance.
- Leave at least 10 cm clearance from walls and other objects.
- To install the appliance, perform the following steps:
 - Remove the packaging of the appliance, except for the pallet.
 - Lift the appliance with the lift truck and move it to the planned installation location. Be careful not to damage the appliance. Control the stability in order not to lose the balance of the appliance.
 - Do not drag nor push the appliance, as it may fall down. This may also cause the damage to external elements or swivel castors.
 - as soon as the appliance is in the planned location, remove the pallet.
 - attach the swivel castors with brakes
 - Remove the protective film from the appliance at the end.

Power supply connection

- Verify if technical data of the appliance (see rating plate) correspond with the local electric power grid specification.
- Connect the appliance to a single, properly grounded mains socket with protective contact. Do not connect the appliance to a multi-socket.
- The power cord should be laid in a way preventing anyone from threading on it or tripping against it.
- Prior to first use, the appliance should be installed and left standing upright for at least 2 hours, before it is connected to power supply.
- After a power failure or when the plug is removed from the socket, do not reconnect the appliance to power supply for at least 5 minutes.

5.2 Operation

Indications for User

- Do not place any heavy objects on the sneeze guard (for example, do not place a stack of plates).
- To place the utensils, etc., use the bottom working surfaces.
- Avoid large amounts of water coming into contact with the wooden parts to prevent blistering and scratching.
- Cool warm food products down to ambient temperature before placing them the appliance.
- The buffet cart should not be used continuously (max 2 - 3 hours), as this appliance is not a refrigerator.
- Use the data in the table below to determine the storage temperatures. The given temperatures (in accordance with the HACCP regulation) are approximate values and may change depending on the environment, sunlight and the amount of food products. For this reason, the storage temperature should be regularly controlled and the storage temperature should be suitably adjusted to these requirements by means of a temperature controller.

EN

Food product		Min. temp. (°C)	Max. temp. (°C)
Bread		+2	+8
Pasta		+2	+7
Meat		+2	+6
Seafood*		0	+4
Gastronomy	Cooked dishes	+2	+10
	Dishes cooked with eggs, milk or jelly	0	+4
Milk products		+2	+4
Cheese		+2	+10
Sliced cold meat		+2	+10
Vegetable	whole	+8	+10
	selection (sliced)	+2	+6

*We recommend that you place seafood on top of a layer of ice flakes.

Preparation of Appliance

1. Before use, clean the appliance observing instructions in section **6 'Cleaning'**.
2. Make sure the drain tap is closed.
3. Plug the appliance into a suitable single socket.

The LED lighting integrated into the hygiene cover is activated as soon as the mains plug is plugged in or is switched on via the lighting switch.

4. Switch the appliance on with the ON/OFF push-button.

The green power indicator light in the ON/OFF switch lights up.

When the appliance is switched on, the indicator lights test is carried out; the digital temperature controller and the LED diodes are blinking for a couple of seconds in order to control their proper operation.

The appliance cools down to the factory set temperature of 2 °C. The digital display shows the current temperature in the cooling bath.





The needed food products may be put in the appliance in suitable GN containers only when the appliance reaches the set temperature.

5. Follow the instructions in the sections below to enter further temperature settings.

Digital Temperature Controller





Fig. 2

Key	Name	Functions
	Function key	<ol style="list-style-type: none"> 1) HACCP data display 2) Pressed for 5 seconds to start or stop manual defrost (if LFC = 0) without waiting for dSd or to turn on/off the controller (if LFC = 1) 3) in the programming mode: to exit the parameter menu without saving the new setting values (Esc command) 4) during an alarm event: to disable the optional internal buzzer and relay
	Enter key	<ol style="list-style-type: none"> 1) Programming Mode Activation 2) View and confirm new setting values
	Setting value decrease button	<ol style="list-style-type: none"> 1) Keep pressed together with the Enter button for 5 seconds to lock or unlock the buttons 2) In the programming mode: to scroll through the parameter menus and decrease the setting values
	Setting value increase button	<ol style="list-style-type: none"> 1) To display the temperature of the current probe 1 for a few seconds 2) In the programming mode: to scroll the parameter menus and increase setting values

LED Indicators

The LED indicators in the digital display show the status of the active function:





LED	Status of the active function	Meaning
	illuminates	the compressor is running (K1 output relay is on, Act = 0)
	flashes	during compressor start delay
	illuminates	the heater is working (the K1 output relay is on, Act = 1)
	flashes	during the heater delay time
	illuminates	defrosting in progress
	flashes	during the delay after defrost

The upper left point flashes in programming mode and lights when the external contact (digital input) is active or in Standby mode.

The number "1" that appears on the digital display shows the current temperature of the sensor.

EN

Setting the temperature (required value)

1. Press the  button once for a moment.
The digital display shows "SET". The upper point to the left of the temperature gauge is flashing to indicate entering programming mode.
2. To display the set value, press the  button again.
3. To set the required set value, press the  or  button within 15 seconds.
4. Press the  button to confirm the set data.

NOTE!

If this button is not operated for more than 15 seconds (Timeout) or when the  button is pressed once, the last value shown on the display will be adopted and the previous message will be displayed again.

Automatic Defrosting

The appliance defrosts automatically 4 times over a 24-hour period. The timer initiates with the first activation.

1. If there is a need for the change of automatic defrosting phases, press the  button and hold it for more than 5 seconds.

The appliance will start defrosting immediately, and the next defrosting process will commence after 6 hours.

Manual Defrosting

Additionally, aside of the automatic defrosting, manual defrosting may be activated:

1. Press and keep the  button pressed for over 5 seconds.



The manual defrosting is initiated.

The process is activated only when certain temperature conditions are fulfilled (when LFc=0). If they are not fulfilled, the display will blink to communicate that the process is not carried out.

NOTE!

If additional parameter settings are necessary, contact technical service.

Button lock

1. Press and hold the buttons  and  simultaneously for 6 seconds to lock and unlock the keypad (the top point to the left of the temperature gauge is blinking).

When "Pof" appears on the digital display, the keypad is locked. When "Pon" is displayed, the keypad is unlocked.

When the keypad is locked, all parameters can be displayed but not changed.

Display of stored alarm temperatures (HACCP function)

The digital temperature controller saves the last 3 temperature alarm events:

The sensor temperature was lower than ALo or higher than AHi.

- if the temperature controller shows temperature (i.e. not in programming mode), press and release the button  ;
- the message "HcP" (HACCP) and (if alarm data are stored) the message "AL1", min./max reached temperature and its duration in minutes appears, when temperature 1 was above ALo or AHi, next "AL2" min-/max alarm appears. AL1 refers to the most recent event. AL3 is the oldest.

When HACCP data is displayed on the digital display by pressing the button  for more than 5 seconds ("----" is displayed), the stored alarm data can be erased.

The digital temperature controller only displays alarm data for events that have returned to normal state. If the alarm continues, it can be terminated by ending ALo or increasing the AHi value. At the end of the alarm, the HACCP data is saved.

There is no alarm recording during the defrost process.

The temperature controller is not equipped with a battery, if a power failure occurs, no data is monitored/saved.

If the recorded temperature unit is changed (parameter "unt"), the recorded temperatures/parameter values reflect the unit set in the past (they are not converted).

Parameter alarms

Country	Description	Value	Initial settings
Atp	Alarm type values 0: ALo, AHi are absolute temperatures; 1: ALo, AHi are the temperature values related to the SEt value.	0..1	0
ALo	Low temperature alarm (ex LoA). If the temperature drops below this value (ALo-0,4), the controller transmits an alarm signal on the display and starts recording the minimum temperature and the alarm duration (HACCP function). In addition, it activates an internal buzzer and an alarm relay if available (optional)	AtP=0, -50.. (AHi-1) AtP=1, -50 .. -0.5°C	-40 °C
AHi	Alarm when the temperature is exceeded (ex HiA). If the temperature raises above this value (ALo+0,4), the controller transmits an alarm signal on the display and starts recording the highest temperature and the alarm duration (HACCP function). In addition, it activates an internal buzzer and an alarm relay if available (optional).	AtP=0 (ALo+1)..150 AtP=1 0,5 ..285 °C	110 °C

EN

Switching the appliance off

1. When the appliance is not to be used any more, it should be switched off with the ON/OFF switch at the operating side of the appliance.
2. Disconnect the appliance from power supply by pulling the plug out.

6 Cleaning

6.1 Safety Instructions for Cleaning

- Before cleaning, disconnect the appliance from the power supply.
- Leave the appliance to cool down completely.
- Make sure water does not enter the appliance. Do not immerse the appliance in water or other liquids during cleaning. Do not clean the appliance with a pressurized water jet.
- Do not use any sharp or pointed, nor metal implements (knife, fork, etc.). Sharp or pointed implements may damage the appliance, and when in contact with live parts, they may cause electric shock.
- For cleaning, do not use any scouring agents that contain solvents nor corrosive cleaning agents. They may damage the surface.

6.2 Cleaning

1. Clean the appliance regularly at the end of a working day.
2. Take the GN containers out of the cooling bath.

Condensation may collect in the cooling tray for GN containers. To drain it, follow these steps:

- a suitable container under the spout pipe (A)
 - open the spout pipe (A) and drain the condensed water
3. Clean the GN container tub with a soft, damp cloth and dry it thoroughly.
 4. Close the drain tap.

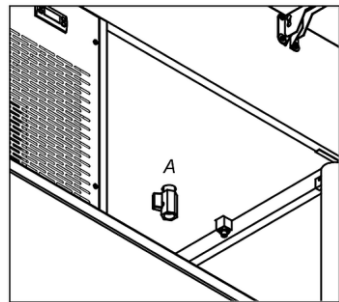

Fig. 3

5. Clean the hygienic cover with a soft, damp cloth and dry it thoroughly.
6. Only clean laminated wooden surfaces with a slightly damp cloth. For stubborn stains, use a little alcohol.
7. Clean the GN container in use thoroughly with running hot water, a soft cloth and mild cleaning agent.
8. Rinse the GN containers in clean water and dry or leave to air dry.

7 Disposal

Electrical Appliance



Electric appliances are marked with this symbol. Electrical appliances must be disposed of and recycled in a correct and environmentally friendly manner. You must not dispose of electric appliances with household waste. Disconnect the appliance from the power supply and remove power cord from the appliance.

EN

Electrical appliances should be returned to designated collection points.

Coolant

The propellant used in the appliance is flammable. It should be utilised pursuant to national regulations in force.