

380



700841

Bartscher GmbH
Franz-Kleine-Str. 28
D-33154 Salzkotten
Germany

Phone: +49 5258 971-0

Fax: +49 5258 971-120

Technical Support Hotline: +49 5258 971-197

www.bartscher.com



Version: 2.0

Date of preparation: 2024-06-28

Original instruction manual

1	Safety	2
1.1	Explanation of Signal Words	2
1.2	Safety instructions.....	3
1.3	Intended Use	7
1.4	Unintended Use	7
2	General information	8
2.1	Liability and Warranty	8
2.2	Copyright Protection	8
2.3	Declaration of Conformity	8
3	Transport, Packaging and Storage	9
3.1	Delivery Check.....	9
3.2	Packaging	9
3.3	Storage	9
4	Technical Data.....	10
4.1	Technical Specifications	10
4.2	List of Components of the Appliance	12
4.3	Functions of the Appliance.....	13
5	Installation and operation	14
5.1	Installation.....	14
5.2	Operation	17
6	Cleaning and Maintenance	20
6.1	Safety Instructions for Cleaning	20
6.2	Cleaning.....	21
6.3	Maintenance	23
7	Possible Malfunctions.....	26
8	Disposal.....	28



Read this instruction manual before using and keep it available at all times!

This instruction manual contains information about installation, operation and maintenance of the appliance and constitutes an important source of information and reference guide. The knowledge of all operational and safety instructions included in this manual is a prerequisite for safe and proper handling of the appliance. Additionally, accident prevention, occupational health and safety, and legal regulations in force in the area the appliance is used apply.

Before you start using the appliance, especially before turning it on, read this instruction manual in order to avoid personal injuries and property damages. Improper use may cause damage.

This instruction manual forms an integral part of the product and must be stored in an immediate vicinity of the appliance and be available at all times. The instruction manual should be transferred together with the appliance.

1 Safety

This appliance has been manufactured in accordance with technical standards currently in force. However, the appliance may be a source of hazards if used improperly or contrary to its intended purpose. All persons using the appliance must consider information included in this instruction manual and observe safety instructions.

1.1 Explanation of Signal Words

Important safety instructions and warning information are indicated in this instruction manual with appropriate signal words. You must strictly follow the instructions, to prevent accidents, personal injuries and property damages.



DANGER!

The signal word **DANGER** warns against hazards that lead to severe injuries or death if the hazards are not avoided.



WARNING!

The signal word **WARNING** warns against hazards that may lead to moderate or severe injuries or death if the hazards are not avoided.



CAUTION!

The signal word **CAUTION** warns against hazards that may lead to light or moderate injuries if the hazards are not avoided.

IMPORTANT!

The signal word **IMPORTANT** indicates possible property damages, which may occur if safety instructions are not observed.

NOTE!

The symbol **NOTE** indicates subsequent information and guidelines for the user on usage of the appliance.

1.2 Safety instructions

Electrical Current

- Too high a mains voltage or incorrect installation may cause electric shock.
- The appliance may be connected only if data on the rating plate correspond with the mains voltage.
- To avoid short-circuit, the appliance should be kept dry.
- If there are malfunctions during operation, disconnect the appliance from the power supply.
- Do not touch the appliance's plug with wet hands.
- Never take hold of the appliance if it has fallen into water. Immediately disconnect the appliance from the power supply.
- Any repairs or housing opening may be carried out by professionals and relevant workshops only.
- Do not transport the appliance, holding it by the power cord.
- Do not allow the power cord to come into contact with heat sources or sharp edges.
- Do not bend, pinch nor knot the power cord.

- Always completely unwind the power cord.
- Never place the appliance or other objects on the power cord.
- Always take hold of the plug to disconnect the appliance from the power supply.
- Check the power cord regularly for damage. Do not use the appliance if the power cord is damaged. If this cable is damaged, it must be replaced by customer service or a qualified electrician in order to avoid dangers.

Fire hazard / flammable materials hazard / explosion hazard!

- Do not use any electric devices in the appliance.
- Do not store nor use petrol or other flammable liquids and gases in the vicinity of this or any other appliance. Those gases may cause fire or explosion hazard.
- Do not put into the appliance any explosive materials, like sprays filled with flammable propellants. Contents of containers filled with flammable gases and liquids may leak in low temperatures, and the contents may catch fire from sparks generated by an electric appliance. Explosion hazard!
- In the case of coolant leakage, pull the plug from the socket. Remove all sources of ignition in the vicinity, ventilate room and contact technical service. Avoid coolant getting in contact with eyes, as it may cause serious eye damage.
- Never use any flammable liquids for cleaning the appliance or its parts. Gases released may cause fire or explosion hazard.
- In the case of fire, disconnect the appliance from the power supply before attempting adequate fire-extinguishing actions.
- Never attempt to extinguish fire with water if the appliance is connected to the power supply. Following extinction of fire, ensure sufficient fresh air inflow.
- Defrosting process may not be sped up with mechanical means or heat energy sources (candles or heaters) nor with any other means. Vapour produced may cause short-circuit and too high temperatures may damage the appliance.
- All ventilation slots should not be obstructed during operation.
- Never attempt to damage cooling installation of the appliance.

Health Risk from Spoiled Meat

- Only use meat suitable for processing.
- Wear food-grade gloves when handling meat, stainless steel racks, hanging rods and meat hooks.
- When meat is dry-aged, a hazard may occur in the form of the so-called 'wild mould'. Unlike the 'good noble mould', this mould can spoil the meat and cause toxic and allergic reactions.

For this reason, ensure impeccable hygiene when handling the appliance and meat, and obtain comprehensive information on dry-ageing from a trustworthy butcher/expert.

- A noticeable sour smell may indicate the appearance of a wild mould.
- Once ageing is complete, dark and dry areas should be removed by cutting them out wide and in excess.
- Do not consume out-of-date food products, as they can lead to food poisoning.

ATTENTION!

The manufacturer assumes no liability for damage to refrigerated goods, even in the event of a defect in the appliance during the warranty period. The manufacturer also disclaims liability for damage to persons caused by improperly stored goods that are subsequently consumed.

EN

Operating Personnel

- This appliance must not be used by children.
- Keep the appliance and the power cord away from children.
- Children should be supervised to ensure that they are not playing with or switching the appliance on.
- Cleaning and user maintenance may not be performed by children.
- The appliance may be used by people with reduced physical, sensory or mental abilities and those with limited experience/knowledge as long as they are under supervision or have been instructed on safe use of the appliance and possible risks. Do not leave the appliance unattended during operation.

Improper Use

- Unintended or prohibited use may cause damage to the appliance.

- The appliance may only be used when its technical condition is flawless and allows for safe operation.
- The appliance may only be used when all connections are executed according to rules of law in force.
- The appliance may only be used when it is clean.
- Use only original spare parts. Never attempt to repair the appliance on your own.
- Do not introduce any changes in the appliance nor modify it.

- This appliance is not a refrigerator. Do not store any food products in the appliance other than those specified in 'Intended use' section.
- Do not use the appliance for smoking.
- The appliance actively regulates the required air humidity. Do not place any salt blocks in the appliance to regulate the air humidity. The appliance might get damaged. If salt blocks are nevertheless used, the warranty on the appliance shall be void. The manufacturer accepts no liability for damage to the appliance or meat.

1.3 Intended Use

As described below, every use of the appliance for a purpose differing and/or diverging from its intended standard use, is prohibited and considered to be an unintended use.

The following is an intended use:

- Storage and ageing of meat (beef, pork, game, etc.).

1.4 Unintended Use

An unintended use may lead to personal injuries or property damages caused by hazardous voltage, fire or high temperature. The appliance may only be used to perform tasks described in this instruction manual.

The following is an unintended use:

- Storage of fish.
- Storing flammable or explosive objects and liquids, such as ether, petroleum or adhesives;
- Storing explosive materials, like sprays filled with flammable propellants;
- Storing pharmaceutical products or preserved blood;
- Storing live pets.

2 General information

2.1 Liability and Warranty

All information and instructions in this instruction manual account for legal regulations in force, current level of technical engineering knowledge as well as our expertise and experience, developed over the years. If special models or additional options are ordered, or state-of-the-art technical solutions were implemented, the actual scope of delivery of the appliance may, in some circumstances, differ from descriptions and numerous drawings in this instruction manual.

The manufacturer is not liable for any damages nor faults stemming from:

- failure to observe instructions,
- unintended use,
- technical alterations introduced by the user,
- usage of unapproved spare parts.

We reserve the right to introduce technical modifications to the product, intended for improvement of the appliance and its performance.

The warranty period for this appliance is 24 months, counted from the purchase date.

2.2 Copyright Protection

This instruction manual, and texts, drawings and images included in it, as well as its other components are copyright protected. It is prohibited to reproduce this instruction manual (including its excerpts), in any form and by any means, and to use and/or transfer its content to third parties without manufacturer's written permission. Violation of the above results in obligation to pay compensation. We reserve the right to claim further damages.

2.3 Declaration of Conformity

The appliance meets the currently applicable standards and guidelines of the European Union. We confirm the above in the EC Declaration of Conformity. We may provide relevant Declaration of Conformity upon request.

3 Transport, Packaging and Storage

3.1 Delivery Check

Immediately upon reception, check the delivery for completeness and possible shipping damage. In the case of visible transport damage refuse to accept the appliance or accept it conditionally. Mark and note the scope of damage in shipping documents/consignment list of the shipping company and lodge a complaint.

Concealed damage must be reported immediately upon its discovery, as compensation claims may only be filed within applicable time limits.

If you find that parts or accessories missing, please contact our Customer Service Department.

3.2 Packaging

Do not dispose of the appliance cardboard box. It may be used to store the appliance when relocating or when shipping the appliance to our service point in the case of any damages.

The packaging and its elements are made of recyclable materials. Particularly, these are: plastic films and bags, cardboard box.

When disposing of the packaging, observe applicable domestic regulations. Recyclable packaging materials should be recycled.

EN

3.3 Storage

Leave the packaging closed until installation of the appliance; observe external indications concerning method of placing and storage. Store the packaging in the following conditions only:

- in closed rooms;
- in dry and dust-free surrounding;
- away from aggressive agents;
- in a location protected against sunlight;
- in a location protected against mechanical shocks.

In the case of extended storage (over three months), make sure you check the condition of the packaging and the parts regularly. If needed, replace the packaging with a new one.

4 Technical Data

4.1 Technical Specifications

Name:	Dry Age cabinet 380
Art. No.:	700841
Material:	steel plate, tinted glass
Inner material:	stainless steel
Volume, in l:	380
Inner chamber dimensions (W x D x H), in mm:	495 x 532 x 1600
Temperature range, min.–max., in °C:	2 - 14
Temperature control every °C:	1
Air humidity, from–to, in %:	50 - 85
Air humidity adjustment, in %:	1
Number of activated carbon filters:	2
Coolant, amount in kg:	R600a / 0,065
Ambient temperature, min.–max., in °C:	18 - 38
Climate class:	ST
GWP index:	3
Insulation:	C5H10
Number of shelves:	7
Shelf dimensions (W x D x H), in mm:	6x476 x 490 x 25 1x495 x 305 x 30
Load-bearing per rack, in kg:	20
Rod dimensions (Ø x L), in mm:	25 x 495
Hanging rack load-bearing, in kg:	80
Power supply:	0,24 kW 230 V 50 Hz
Dimensions (W x D x H), in mm:	595 x 750 x 1865
Weight, in kg:	122,1

We reserve the right to implement technical modifications.

Version / Characteristics

- Cooling: circulating air
- Temperature control: electronic
- Control unit: touch
- Thermostat
- Insulation: Cyclopentane C5H10
- Automatic defrost function
- Evaporation of condensed water
- Type of shelves: racks
- Height-adjustable shelves
- Digital display
- Internal lighting: LED
- Lockable
- ON/OFF switch
- Number of doors: 1
- Door type: leaf door, glass
- Type of glazing:
 - triple glazing
 - tinted
 - UV filter glass
- Safety glass
- Door hinge side: right, door hinges cannot be changed
- Features:
 - anti-bacterial UV light
 - odour neutralization owing to activated carbon filters
- The set includes:
 - 2 activated carbon filter
 - 1 drip tray
 - 7 stainless steel grates
 - 1 handle with assembly material
 - 2 hanging rods + 6 meat hooks
 - 2 keys
 - 4 humidity filter + holder + drip tray

4.2 List of Components of the Appliance



Fig. 1

Technical Data

Description for Fig. 1

- | | |
|--|--|
| 1. Control panel | 2. LED lighting |
| 3. Appliance door | 4. Door handle |
| 5. Activated carbon filter (2 pcs) | 6. Drip tray |
| 7. Cold air outlet ventilation openings | 8. Lock |
| 9. Feet (4x), height-adjustable | 10. Humidity filter (2 pcs) |
| 11. Warm air outlet ventilation openings | 12. Stainless steel grates (7 pcs) |
| 13. Housing | 14. Hanging rack (2 hanging rods + 6 meat hooks) |

4.3 Functions of the Appliance

The Dry Age cabinet is intended for storing and ageing suitable meat with appropriate temperature settings.

5 Installation and operation

5.1 Installation

ATTENTION!

Due to high weight of the appliance it should be transported, unpacked, and installed by two persons.

Unpacking / Positioning

- Remove the appliance from the packaging and discard all the packing materials, excluding the pallet.



CAUTION!

Choking hazard!

Prevent children from accessing packaging materials, for instance: plastic bags and EPS elements.

EN

- To install the appliance, perform the following steps:
 - The appliance may only be transported to installation location in vertical position. In order to avoid damage to the compressor, do not tilt the appliance more than 45° when positioning or transporting it.
 - Lift the appliance with the lift truck and move it to the planned installation location. Be careful not to damage the appliance. Control the stability in order not to lose the balance of the appliance.
 - Do not drag nor push the appliance, as it may fall down. This may also cause the damage to external elements or swivel castors.
 - Remove the appliance from the pallet in the installation location and install it.
- If the appliance is covered with a protective film, remove it. Remove the film slowly, so no glue residues are left. Remove any glue residues with the use of a suitable solvent.
- Be careful not to damage the rating plate and warning labels affixed to the appliance.
- **Never** place the appliance in humid or wet environment.
- Place the appliance in a way making the connections easily accessible, so that they may be quickly disconnected if such a need arises.
- The appliance should be placed on a surface that is:

Installation and operation

- even, with sufficient load-bearing capacity, resistant to water, dry and resistant to high temperatures;
 - sufficiently large, and thus enabling usage of the appliance with no problems;
 - easily accessible;
 - well ventilated.
-
- Do not place the appliance in direct sunlight or in the vicinity of heat sources (cooker, radiator, heating devices, etc.). Heat sources may negatively affect power consumption, and restrict functions of the appliance, too.
 - Place the appliance so that sufficient air circulation is ensured. Do not obstruct nor cover ventilation openings of the appliance.
 - Leave a clearance of at least 15 cm from walls and other objects.

 - Do not position the appliance in high humidity locations. Excessive humidity may cause rust and negatively influence the refrigerating efficiency of the appliance.
 - The appliance should be installed only in rooms, in which ambient temperature falls within the range of 18–38°C.

 - The appliance is delivered with 3 large feet and one height-adjustable foot. Adjust the small foot to make the appliance stand straight and do not sway.

Fixing of Door Handle

1. Before the first use, fix the supplied stainless steel handle to the appliance door.
2. Move the rubber seal on the door internal side left or right to uncover the fixing holes.
3. Fix the handle to door with enclosed screws.
4. Then replace the seal in correct position.

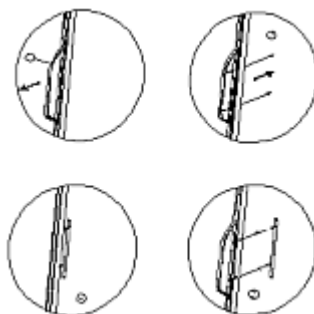

Fig. 2

Power supply connection

- Verify if technical data of the appliance (see rating plate) correspond with the local electric power grid specification.
- Connect the appliance to a single, properly grounded mains socket with protective contact. Do not connect the appliance to a multi-socket.
- The power cord should be laid in a way preventing anyone from threading on it or tripping against it.
- Prior to first use, the appliance should be installed and left standing upright for at least 12 hours, before it is connected to power supply.
- After a power failure or when the plug is removed from the socket, do not reconnect the appliance to power supply for at least 15 minutes.

5.2 Operation

Before First Use

1. Before the first use, clean the appliance inside and outside, as well as accessories, using luke-warm water and a soft cloth. Follow the instructions in section 6 '**Cleaning**'.
2. To end with, dry the appliance and accessories thoroughly.
3. Insert stainless steel racks and hanging rack in the appliance.

ATTENTION!

Make sure the stainless steel racks, and also the hanging rack for hanging meat hooks are correctly snapped-in before they are inserted in the appliance or meat is hung on them.

Control Elements and Displayed Messages



Fig. 3

A Temperature display

B Air humidity display



UV light key



Air temperature / humidity function key



Setting value increase key



Setting value decrease key





Internal LED lighting key



ON/OFF switch

Appliance Start-Up

1. Plug the appliance into a suitable single socket.
2. To switch the appliance on, press the ON/OFF switch  on the control panel.
3. Then, switch the UV light for at least 2 hours to disinfect the internal chamber.



To this end, press the  key.

4. Remove the entire plastic packaging from humidity filters.
5. Before putting meat into the appliance, fill both humidity filters with 300 ml of potable water each.



Setting Air Temperature and Humidity

1. Press the  key to execute temperature and air humidity settings:

When the  key is pressed once, the temperature display (A) blinks.

The temperature may be set with  or  keys, in the range of 2–14°C, and in 1°C increments.

When the  key is pressed twice, the air humidity display (B) blinks.

The humidity may be set with  or  keys, in the range of 50–85%, and in 1% increments.

If no setting is entered within 3 seconds, the appliance retains current settings.
The appliance automatically returns to displaying temperature.

NOTE!

Place/hang meat in the appliance only when the required temperature is reached in the inner chamber.

To obtain optimum ageing results, we recommend the following setting:
Temperature: 3°C / Air humidity: 75%

By pressing the  and  keys simultaneously for 3 seconds it is possible to switch between displaying temperature in °C and °F.

Switching the LED Lighting and UV Light ON

1. Press the  key, to switch the LED lighting on.
The LED lighting switches on.

2. Press the  key, to switch on the UV lighting on.

NOTE!

The appliance door is equipped with safety switch. When the appliance door is opened, the UV light switches off automatically. When the appliance door is closed, the UV light switches on again.

The UV light is intended for cleaning the inner chamber before, during and after the ageing process.

EN

Switching the Appliance Off

1. If the appliance is not to be used any more, it should be switched off with the ON/OFF switch.
2. To end with, disconnect the appliance from the socket (pull the mains plug out).

Indications for User on Dry-Ageing

- Dry-ageing of beef and pork, as well as game, is a complex process that requires time and ideal conditions.
- High-quality meat should be placed on stainless steel racks or hung on meat hooks on hanging rods.
- Meat should be checked regularly for wild mould.
- When meat has reached the desired degree of maturity, it should be taken out, cut as required and prepared.

Different Aromas Depending on Ageing Time

A subtle nutty aroma may be achieved, depending on the meat used, after approx. 21 days.

An aroma reminiscent of mushrooms may be achieved, depending on the meat used, after approx. 28–35 days.

A strong aroma reminiscent of blue cheese may be achieved, depending on the meat used, after approx. 45 days or more.

The longer the meat is aged, the stronger the aroma will be.

6 Cleaning and Maintenance

6.1 Safety Instructions for Cleaning

- Before cleaning, disconnect the appliance from the power supply.
- Leave the appliance to cool down completely.
- Make sure water does not enter the appliance. Do not immerse the appliance in water or other liquids during cleaning. Do not clean the appliance with a pressurized water jet.
- Do not use any sharp or pointed, nor metal implements (knife, fork, etc.). Sharp or pointed implements may damage the appliance, and when in contact with live parts, they may cause electric shock.
- For cleaning, do not use any scouring agents that contain solvents nor corrosive cleaning agents. They may damage the surface.

6.2 Cleaning

1. Clean the appliance thoroughly after each ageing process.
2. Take the meat out. Use food-grade gloves.
3. Observe the following instruction on cleaning individual accessories and components.

Stainless Steel Racks, Hanging Rack and Drip Tray

1. Remove the stainless steel racks, drip tray, hanging rods and meat hooks. To remove the stainless steel rack, you need to lift it a bit and then pull out.
2. Clean the stainless steel racks, drip tray, hanging rods and meat hooks thoroughly, using warm water, a soft cloth or sponge, and a mild, food-grade cleaning agent. Rinse with fresh water. Dry the cleaned parts thoroughly with a soft cloth.

Humidity filter

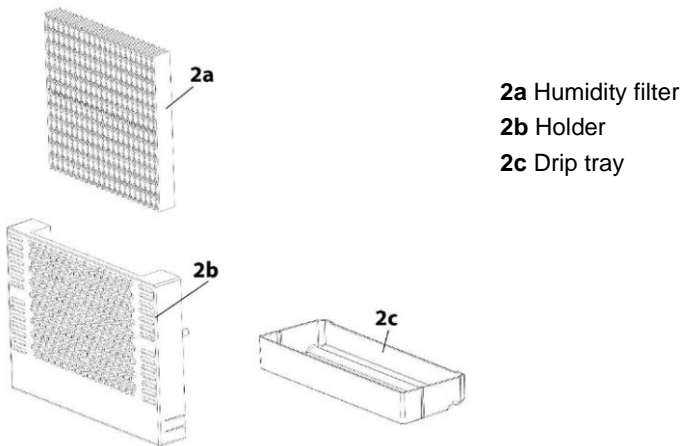

Fig. 4

1. Remove the holder with drip tray from the appliance.
2. Remove the humidity filter from the holder.
3. Loosen the drip tray by pressing the holder at the bottom side and remove the tray.
4. Clean the holder and the drip tray with a luke-warm water and a dash of a cleaning agent. Dry the elements afterwards.

NOTE!

Replace the humidity filter after use very 3 months.

Inner Chamber

1. Clean the inner chamber and inner surface of the appliance door with a luke-warm water, a mild, food-grade washing agent and a soft cloth.
2. The washed surfaces should be thoroughly dried with a clean cloth.
3. Then, dry the cleaned surfaces thoroughly using a soft cloth.

Appliance Door / Door Seals

1. Clean the outer glass surfaces of the appliance door with a glass cleaning agent.
2. Use a soft cloth to wipe the appliance door dry.
3. Clean the door seal regularly only with a soft, damp cloth.
4. In order to assure correct closing of the appliance door and operation of the appliance, make sure that particularly the door seal is clean.

Housing

1. Clean the outer surfaces of the appliance with a commercially available cleaning agent for stainless steel surfaces. Observe instructions of a cleaning agent's manufacturer.
2. Then dry the appliance thoroughly with a soft cloth.

6.3 Maintenance

Condensate Tank (K)

If there were major temperature fluctuations or if the appliance is to be switched off for a longer time, we recommend checking the condensate tank / drip tray.

Temperature fluctuations may occur, for example, due to power outage, extended/frequent appliance door opening, when the appliance is operating, or appliance faults.

The condensate tank (K) is located at the rear wall of the appliance, bottom right.

1. Remove the metal cover.
2. Using a sponge, regularly remove the condensed water (if it is collected) from the condensate tank (K).
3. To end with, screw the metal cover again.



Fig. 5

Manual Defrosting

1. After each ageing process, leave the appliance for 24 hours to defrost.
2. Switch the appliance off, but do not pull the plug out.
3. Then start the manual defrosting. Pay attention to the drip tray (K) and remove water that drips during the defrosting process.

If the appliance is iced, proceed the following way:

- Remove meat from the appliance.
- Cover it with food film or, if possible, put it into a plastic bag and chill in a chiller.
- Switch the appliance off.
- Fill a pot with hot, but not boiling potable water and place the pot on a cloth on the bottom stainless steel rack.

WARNING!

Risk of scalding by hot water!

Handle the pot with hot water carefully.

Water vapour will melt the ice within approx. an hour. Water generated in the process of melting will collect in the inner chamber and may be also collected in the drip tray (K).

- Take the pot and the cloth out of the appliance.
- Wipe the water in the inner chamber.
- Empty the drip tray (K).
- Use a soft cloth to wipe the appliance dry.
- Leave the appliance open for an hour to let it dry completely.

Activated Carbon Filter

The activated carbon filter should be replaced once a year. To this end (if needed) remove meat and screw the filter out to replace it.

UV Lamp Replacement

1. Loosen the UV lamp fixture screws carefully.
2. Remove the UV lamp fixture.

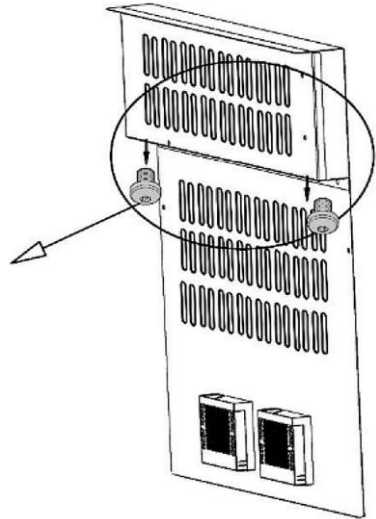
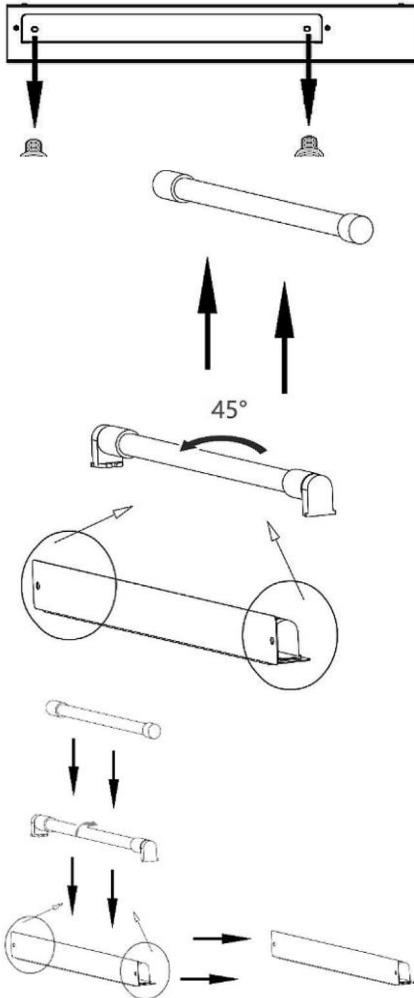

3. Hold the UV lamp and rotate it by 45°.
4. Remove the UV lamp and replace it with a new UV lamp.
5. Assemble in reverse order (Fig. at the bottom).

EN

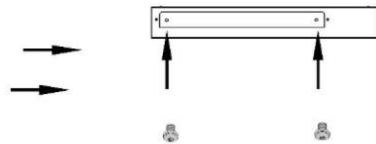

7 Possible Malfunctions

The table below contains descriptions of possible causes and solutions to malfunctions or errors during operation of the appliance. When malfunction cannot be removed, contact the technical service.

Error	Possible Cause	Solution
Appliance does not work	Incorrectly connected plug	Pull the plug out and insert it properly in a socket
	Electric power supply safety fuse damaged	Check the fuse, connect the appliance to another socket
	No power supply	Check the electric power supply
	Damaged socket	Plug the appliance into another socket
	Damaged mains power plug	Contact the service company
Insufficient cooling performance	Incorrect setting temperature	Check the set temperature and adjust it if needed
	Door is not closed properly or it has been opened for too long	Close the door tightly; limit the door opening time to minimum
	Damaged or deformed door seal	Contact the service company
	Poor air circulation around the appliance	Keep sufficient clearance from walls or other objects Defrost the appliance
LED lighting / UV light does not work	LED lighting / UV light damaged	Contact the service company

Possible Malfunctions

Error	Possible Cause	Solution
Appliance is vibrating	The appliance is not placed on even surface	Place the appliance on even surface
Appliance operates too loudly	Loose elements (e.g. nuts/screws)	Check all screws and nuts, tighten them if necessary
	The appliance is not placed on even surface	Place the appliance on even surface
	Appliance touches walls or other objects	Keep sufficient clearance from walls or other objects
Door fails to close properly	The appliance is not placed on even surface	Place the appliance on even surface
	Worn door seal	Contact the service company
	Stainless steel racks have slipped	Fix the stainless steel rack correctly in the inner chamber
Digital display shows no indications	Damaged temperature controller	Pull the plug out, wait 2 minutes, reconnect the plug; if the fault has not been rectified, contact the service company
	Damaged mains power plug	
Compressor does not start	Room temperature is lower than the required temperature	Pay attention to the ambient temperature
Dew on the appliance's surface	Air humidity in installation location is too high	Use a soft cloth to wipe the dew

The following phenomena are not malfunctions:

Various sounds that are generated by the appliance during operation are a normal phenomenon and do not indicate any malfunctions:

- Splashing, bubbling and hums are generated by the coolant that circulates the system.
- Short, louder whirring/hooting or clicking sounds may be heard when the compressor of the appliance starts for the pre-set temperature of the appliance internal chamber be restored.

Error Code Messages

Error Codes	Problem	Solution
H1	Door has been open for too long	Close the door
	Door contact switch issue	Contact the service company
H2, H5	Sensor error	Contact the service company
H3	Cooling issue	Contact the service company
H4	Air humidity issue	Contact the service company
H6	Defrosting process issue	Defrost the appliance
E9	Display issue	Contact the service company

If performing the above actions has not solved the problem, contact the service company.

8 Disposal

EN

Electrical Appliance

	Electric appliances are marked with this symbol. Electrical appliances must be disposed of and recycled in a correct and environmentally friendly manner. You must not dispose of electric appliances with household waste. Disconnect the appliance from the power supply and remove power cord from the appliance.
--	--

Electrical appliances should be returned to designated collection points.

Coolant

The propellant used in the appliance is flammable. It should be utilised pursuant to national regulations in force.