

ENK-3EB



300064







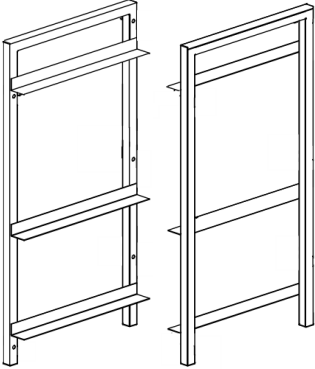

Technical data

- Name: • **Trolley for cleaning ENK-3EB crates**
- Art. number: • **300064**
- Material: • Nickel-chrome steel
- Realization: • Frame: pipes of square section 25.8 x 25.8 mm;
Suitable for Euro-Norm E1, E2, E3 crates
(meat / bakery products), dimensions: 600 x 400 mm
3 pairs of guides;
4 swivelling rubber castors, Ø 100 mm
1 buffer, 2 swivelling castors with stoppers;
Easy assembling kit
- Dimensions: • W 720 x D 500 x H 965 mm
- Maximum carrying capacity: • 100 kg in total, 40 kg per slot
- Distance between slots: • 118 mm at the top (E1),
380 mm in the middle (E1, E2, E3),
250 mm at the bottom (E1, E2)
- Weight: • 9.4 kg
-

We reserve the right to implement the technical modifications!

- Unpack the individual elements and remove the packaging material.
- Check completeness of delivery according to the list below.
- An additional spanner is required for the assembly of the trolley.
- Remove the protective foil from the trolley for cleaning crates.

Delivery range / Part name

No.	Element	Number	Name
1 + 2		2	Left and right side elements with 3 initially mounted guides
3		5	Cross members
4		2	Castors with stoppers
5		2	Castors without stoppers
6		4	Buffers for castors
7		20	Square washers
8		10	Bolts
9		1	Allen wrench

Assembly

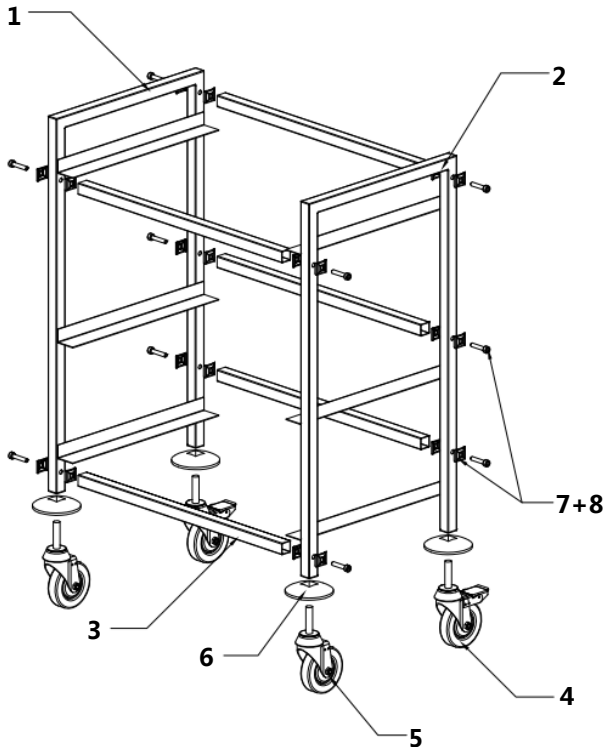

1. First, fasten 5 crossbars (3) to the left side element (1). For this purpose, insert one square washer (7) between the crossbar (3) and the side element (1) and between the side element (1) and the bolt (8), and then tighten it with the Allen wrench.
2. Fasten the crossbar (3) to the right side element (2), as described in the previous item.
3. Lay or place the trolley for cleaning crates on its side. Attach the buffers (6) to the side elements (1+2). Next, screw 4 swivel castors (4 + 5) into the side elements.
4. Place the trolley for cleaning crates on the swivel castors and check its stability.

5. The trolley for cleaning carts may be aligned by adjusting swivel castors. Secure their position with protective nuts.
6. When the trolley for cleaning carts is in the desired location, block the swivel castors (4) with brakes, to prevent it from being accidentally moved or tipped.

Tips for the user

- The trolley is designed for transporting Euro-Norm E1, E2, E3 crates (meat / bakery products) with the dimensions: 600 x 400 mm:
- Place the appropriate Euro-Norm crate on the appropriate guides.
- Distances between the guides in the trolley for cleaning crates make it suitable for the following Euro-Norm crates:
 - at the top** (118 mm): **E1**
 - in the middle** (380 mm): **E1, E2, E3**
 - at the bottom** (250 mm): **E1, E2**



Cleaning instructions

- The trolley for cleaning crates should be regularly cleaned with a moist cloth and mild cleaning agents.
- **Never** use harsh cleaning agents that may damage the surface of the trolley for cleaning crates.
- Dry the trolley for cleaning crates with a soft cloth.