

3000E cod. USER

ed. 09 - 09/2022

EN - Instructions for Installation, Use and Maintenance



110540
110541
110542

LEGGERE ATTENTAMENTE LE ISTRUZIONI PRIMA DI INSTALLARE LA MACCHINA

READ THE INSTRUCTIONS CAREFULLY BEFORE INSTALLING THE MACHINE

LIRE ATTENTIVEMENT LES INSTRUCTIONS AVANT D'INSTALLER LA MACHINE

LESEN SIE VOR DER INSTALLATION DES GERÄTES AUFMERKSAM DIE VORLIEGENDEN
GEBRAUCHSANLEITUNGEN

LEER ATENTAMENTE LAS INSTRUCCIONES ANTES DE INSTALAR LA MÁQUINA

ВНИМАТЕЛЬНО ПРОЧИТАЙТЕ ЭТИ ИНСТРУКЦИИ, ПРЕЖДЕ ЧЕМ ПРИСТУПАТЬ К УСТАНОВКЕ МАШИНЫ

LER ATENTAMENTE AS INSTRUÇÕES ANTES DE INSTALAR A MÁQUINA





Vi ringraziamo per aver acquistato un nostro apparecchio.

Le istruzioni per l'installazione e la manutenzione nonché il suo impiego, che troverete sulle pagine che seguono, sono state preparate per assicurare una lunga vita e un perfetto funzionamento del vostro apparecchio.

Seguite attentamente queste istruzioni.

Noi abbiamo ideato e costruito questo apparecchio secondo le ultime innovazioni tecnologiche. Voi ora dovrete averne cura.

La vostra soddisfazione sarà la nostra migliore ricompensa.

Thank you for choosing our machine.

The instructions for installation, maintenance and use found on the following pages have been prepared to ensure a long life and a perfect operation of your unit.

Please, do follow the instructions carefully.

We have designed and built this machine using the latest innovative technologies. Now you shall take good care of it.

Your full satisfaction is our greatest reward.

Nous vous remercions d'avoir choisi notre machine.

Les instructions pour l'installation, l'entretien et l'utilisation qui figure dans les pages suivantes ont été préparées pour assurer une longue durée de vie et un fonctionnement parfait de votre appareil.

S'il vous plaît, veuillez suivre attentivement les instructions.

Nous avons conçu cette machine, en utilisant les dernières technologies innovantes. Vous devrez maintenant en prendre soin.

Votre satisfaction est notre plus grande récompense.

Wir danken Ihnen für den Kauf dieses Gerätes.

Die Anleitungen zu Installation, Wartung und Betrieb des Gerätes, die Sie auf den folgenden Seiten finden, wurden erstellt, um Ihrem Gerät eine lange Lebensdauer und einen ordnungsgemäßen Betrieb zu gewähren.

Befolgen Sie diese Anweisungen aufmerksam.

Dieses Gerät wurde nach dem letzten Stand der Technik entwickelt und konstruiert. Diese Anleitung soll Ihnen dabei helfen, es gebührend zu pflegen.

Ihre Zufriedenheit ist für uns die beste Entlohnung.

Gracias por haber adquirido uno de nuestros productos.

Las instrucciones para la instalación y mantenimiento, así como su uso, que se encuentran en las páginas que siguen, se han preparado para asegurar una larga vida y un funcionamiento fiable de su unidad.

Sígalas atentamente.

La máquina ha sido proyectada y fabricada con las últimas innovaciones tecnológicas. Por favor, utilícela con cuidado.

Su satisfacción es nuestra mejor recompensa.

Благодарим Вас за выбор нашей продукции.

Инструкции по установке, использованию и обслуживанию, представленные в настоящем руководстве, были подготовлены для того, чтобы обеспечить долгую и исправную службу Вашего оборудования.

Пожалуйста, точно следуйте приведённым в руководстве указаниям и рекомендациям.

Мы разработали и изготовили это оборудование в соответствии с самыми последними техническими достижениями.

Теперь его судьба зависит от Вас.

Лучшая награда для нас - Ваше удовольствие от работы с нашим оборудованием.

Obrigado por adquirir um dos nossos aparelhos.

As instruções de instalação, manutenção e utilização que encontrará nas páginas seguintes foram preparadas para garantir uma longa duração e um perfeito funcionamento do seu aparelho.

Siga estas instruções escrupulosamente.

Idealizámos e construímos este aparelho segundo as últimas inovações tecnológicas. Agora, cabe-lhe a si cuidar dele.

A sua satisfação será a nossa melhor recompensa.

TRANSLATION OF THE ORIGINAL INSTRUCTIONS

Contents	Page
WARNINGS	5
1. MACHINE INSTALLATION	7
1.1 Dataplate	7
1.2 Reception of the appliance	8
1.3 Hydraulic connection	8
1.3.1 Water supply characteristics	8
1.4 Electrical connection	9
2. MACHINE DESCRIPTION	10
2.1 Machine description	10
2.2 Machine features	12
3. CONTROL PANEL AND RELATIVE SYMBOLS	13
4. OPERATION	14
4.1 Cutlery and crockery loading	15
4.2 Use of detergent	15
4.3 Use of rinse aid	16
4.4 Regeneration device (optional)	16
4.5 Drain pump system (optional)	17
4.6 Compliance with hygiene regulations and H.A.C.C.P.	17
5. MAINTENANCE	18
5.1 Regular Maintenance	18
5.2 Special Maintenance	18
6. ALARMS	19
7. ENVIRONMENTAL ASPECTS	19
7.1 Packing	19
7.2 Disposal	19
8. ECOLOGICAL ASPECTS	20
8.1 Recommendations for optimum use of energy, water and additives	20
9. TROUBLESHOOTING	21

WARNINGS



This instruction booklet must be kept with the dishwasher for future consultation. If the dishwasher is sold or transferred to another user, make sure the booklet always goes with the appliance so that the new owner can have the necessary information on operation and the relative instructions.

The instruction booklet must be carefully read before installation and first use of the dishwasher.

The user must comply with the following rules:

- Adaptation of the electrical and water systems for dishwasher installation must only be carried out by qualified operators.
- This dishwasher must only be used by adults. This is a professional machine to be used by qualified personnel, and installed and repaired exclusively by a qualified technical assistance service. The Manufacturer declines any responsibility for improper use, maintenance or repair.
- This appliance can be used by trained youth aged from 15 years and above. It cannot be used by persons with reduced physical, sensory or mental capabilities or lack of experience and knowledge.
- Children shall not play with the appliance.
- Cleaning and user maintenance shall not be made by children without supervision.
- The user must not carry out any repair and/or maintenance operations. In any case contact qualified personnel.
- Accompany the door in opening and closing.
- Servicing of this dishwasher must be performed by authorized personnel.

Note: Use original replacement parts only. Otherwise the product warranty is invalidated and the manufacturer is no longer responsible.

- The dishwasher is designed only and solely for washing plates, glasses and various pots and pans with human food type of residue. DO NOT wash articles polluted with petrol, paint, bits of steel or iron, fragile objects or material not resistant to the washing process. Do not use acidic corrosive chemical products or alkaline and solvents or chlorine based detergents.
- Make sure the dishwasher is not resting on the power cord or the filling and drain hoses. Level the machine by adjusting the support feet.
- Do not use the appliance or any part of it as a stepladder or means of support as it has been designed exclusively to bear the weight of the dishrack containing dishes to be washed.

-
- **The dishwasher is designed only and solely for washing plates, glasses and various pots and pans with human food type of residue. DO NOT wash articles polluted with petrol, paint, bits of steel or iron, fragile objects or material not resistant to the washing process. Do not use acidic corrosive chemical products or alkaline and solvents or chlorine based detergents.**
 - Do not open the machine door when operating. In any case, the machine has a special safety device which immediately stops the unit if the door is open, thus preventing water spillage. Always switch the machine completely off and drain the water tank, before accessing inside.
 - **This machine must be disconnected from the main electrical supply after use at the end of the day and for any service/maintenance operation following this procedure:**
 - Switch the machine off from the control panel.**
 - Drain the tank by removing the overflow pipe.**
 - Disconnect the electrical supply by the omni-polar switch (main switch located on the wall).**
 - Shut the water supply valve(s).**
 - Disregarding the aforesaid prescriptions is a serious misuse and can cause damages and injures to property and people, and will relieve the manufacturer from whatever liability.**
 - Do not use old load pipe, but only new ones.
 - The user must not carry out any repair and/or maintenance operations. In any case contact qualified personnel.
 - Do not use old load pipe, but only new ones.
 - Do not put material or objects on the machine.
 - Some important rules must be followed for using this appliance:
 - Never touch the appliance with wet hands or feet
 - Never use the appliance when barefoot
 - Do not install the appliance in places exposed to water sprays.
 - Do not dip bare hands into water containing detergent. If this should occur, wash them immediately with plenty of water.
 - The water used for the washing and the rinsing is not potable because of the presence of chemical additives. In case of contact with skin or eyes wash them immediately with plenty of water and check the safety instructions of the detergent manufacturer. If necessary, contact a doctor.
 - Only follow the instructions given in the manufacturer's booklet for cleaning operations (see chap. **5. MAINTENANCE**).

-
- The machine has an IP (see serial number label on the machine) protection rating against accidental water splashes and is not protected against pressurized water jets. Pressure-cleaning systems shall, therefore, not be used on this machine.
 - This appliance is designed to work at room temperatures from 5 °C up to a max. 35 °C, in a suitable room.
 - Do not use water to extinguish fires on electrical parts.
 - Do not cover the intake or dissipation grids.
 - Water infeed to the machine 400 kPa maximum.

Note: The manufacturer declines any responsibility for accidents to people or any damage deriving from failure to observe the above listed instructions.



ATTENTION: DO NOT INSERT HANDS AND/OR TOUCH THE PARTS LOCATED AT THE BOTTOM OF THE WASH TANK AND/OR AT THE END OF THE WASH CYCLE.









ATTENTION: INTERNAL CLEANING OF THE MACHINE SHALL BE CARRIED OUT AT LEAST 10 MINUTES AFTER THE POWER SWITCH HAS BEEN TURNED OFF.

1. MACHINE INSTALLATION

1.1 Dataplate

- A Power source
- B Total power installed
- C Dynamic Pressure
- D Envelope protection degree
- E Total electricity absorption

Model Family		DWXXXX		
Model Code		DESCRIPTION		
S/N	DWX10XXXXX	Type		IPXX
	400V 3N 50HZ	xxA		
	xxxxW			
	MAX	xxx-xxx kPa		
	MAX	xx°C		
	MAX	xx°C		
	MAX	xxkPa		
				MADE IN ITALY YYYY
Model				S/N
				

Model DW XXXX

FAMIGLIA PRODOTTO
FAMILY PRODUCT
FAMILLE DU PRODUIT
FAMILIA PRODUCTO
FAMILIE DES PRODUKTES
СЕРИЯ ПРОДКТА

S/N DW X xxxxxxxx

ANNO YEAR ANNÉE AÑO JAHR ГОД ВЫПУСКА
N=2017 - 2018
O=2018 - 2019
P=2019 - 2020
Q=xxxx - xxxx

NUMERO DI SERIE
SERIAL NUMBER
NUMÉRO DI SÉRIE
NUMERO DI SERIE
SERIENNUMMER
СЕРИЙНЫЙ НОМЕР

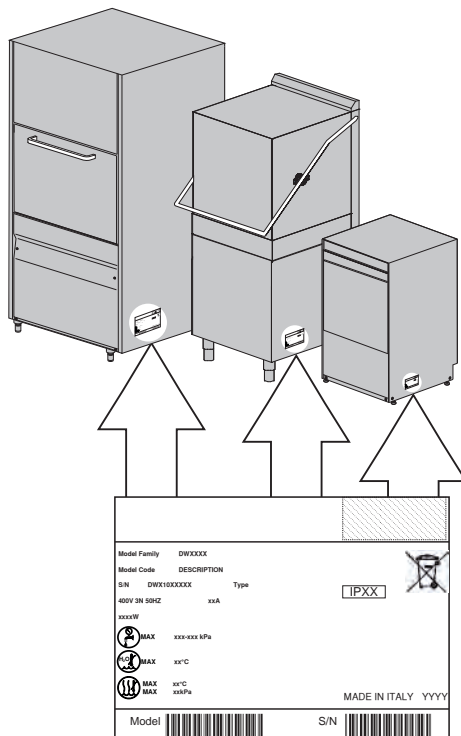

1.2 Reception of the appliance

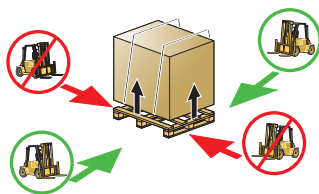

Before accepting the machine, verify that all the data on the data-plate corresponds to the required ones and to the ones of the available electrical supply (see paragr. **1.1 Dataplate**).

After unpacking, make sure the machine has not been damaged during transportation. If so, do notify the seller immediately about the problem. If the damage might question the machine safety, do not install it.

The installation and the starting of the machine must be carried out by trained operators only, even if the machine is coming from another site and it has been used, already.

For disposal of the packing see chap. **7. ENVIRONMENTAL ASPECTS**.

1.3 Hydraulic connection

Connect the machine's water supply with an interrupt valve capable of quickly and completely shutting off water intake. Make sure that the water supply pressure comes within the values given in the table Tab. 1. If it is less than 2 bar dynamic pressure (200 kPa) a pressure pump **must be installed** to guarantee optimal machine operation (by request, the dishwasher can be supplied with a pump). If, however, the water supply pressure is greater than 4 bar (400 kPa), a pressure reducing device **must be installed**.

For water with average hardness greater than 8 °f, a water softener **must be used**. This will result in cleaner dishes and longer life of the appliance. By request, the machine can be equipped with a water softener

If the machine is equipped with a water-softener, a regeneration of the resins shall be done on regular basis. In machines equipped with optional **regeneration device** it is advisable to use water at a temperature not above 40 °C, so as not to alter the characteristics of the resins.

Note: Any damage caused by limestone (calcareous water higher-up than 8 °f and without water-softener) will not be covered by warranty.

In order to ensure the optimum performance, the water supply temperature must come within the range given in table Tab. 1. Machines shall be made with extra power in case of cold water infeed.

Each machine is provided with a rubber tube with a 3/4" threaded attachment for water filling.

Connect the emptying tube, supplied with the appliance, to the union elbow located under the tub so that water flows freely. If it is not possible to empty the water at a level lower than the drain of the appliance, it is advisable to install an emptying pump, which can be provided by request.

The emptying tube should always be connected to a siphon to prevent odor back-up from the screen.

Water characteristics table	Min	Max
Static Pressure	200 kPa	400 kPa
Dynamic Pressure	150 kPa	350 kPa
Water hardness	2 °f	8 °f
Cold water-supply temperature	5 °C	50 °C
Hot water-supply temperature	50 °C	60 °C
Capacity	10 l/min	

Tab. 1

1.3.1 Water supply characteristics

The machine water supply must be potable, in compliance with the legislation in force.

The inlet water must also meet the parameters given in the table Tab. 2.

Water parameters table	Min	Max
Chlorine ¹		2 mg/l
pH	6,5 ¹	8,5 ³
Water hardness		8 °f ²⁻³
Iron ³		0,2 mg/l
Manganese ⁴		0,05 mg/l

Tab. 2

¹ Out of range values might lead to corrosion and jeopardize the life of the machine.

² Should the water hardness is higher **it is compulsory** to install a water softener and check periodically its operation.

³ Out of range values might lead scaling and sediments with a consequent lower performance, functionality, and expected life of the machine.

⁴ 4 Desired value: Out of range values might lead stainless steel blackening/tarnishing.

It is recommended a water test once a year.

1.4 Electrical connection

Electrical connection must be carried out in compliance with the legislation in force and the relevant technical standards. Make sure that the voltage is the same as reported on the data-plate.

It is necessary to install a suitable omni-polar automatic fuse switch sized according to the absorption that assures the complete disconnection from the network in an overvoltage category III condition.

This switch must be incorporated in the supply network, dedicated only and exclusively to this circuit and installed in the immediate vicinity.

The machine has to be absolutely turned off by this switch: only this switch gives the full warranty of complete detachment from the electric network.

Make sure the appliance is linked to an efficient ground connection.

The machine is also provided with a terminal (marked with the symbol ) placed on the back end. It shall be used to bond different appliances via the external bonding conductor, in order to avoid the risk of electric shock.



ATTENTION: Check very carefully if the “ground connection” of the machine is properly sized and fully efficient, and that not too many units are connected to it. An undersized or poor “ground connection” might lead to corrosion and/or pitting effect on the stainless steel plates, even to perforation.



Feed cable: The retailer - importer - installer must ensure that the feed cable complies with the cable insulation category of the workplace, in conformity with current Technical Standards.

2. MACHINE DESCRIPTION

2.1 Machine description

Wall-hung main power switch:
at installation
serviceman supply and
care, according to local
laws



Standard equipment for machine with a 500 mm rack:

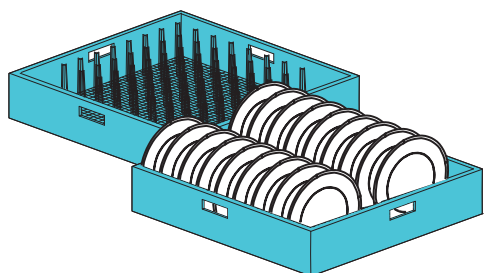

nr. 1 500x500 mm plates rack
Capacity per plate rack:
12 soup plates or
18 flat plates
Max Ø = 340 mm

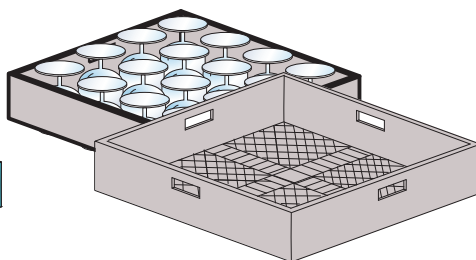

nr. 1 500x500 mm glasses rack

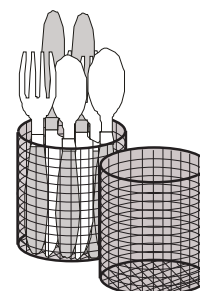

nr. 1 cutlery basket

Standard equipment for machine with a 400 mm rack:
Option A)

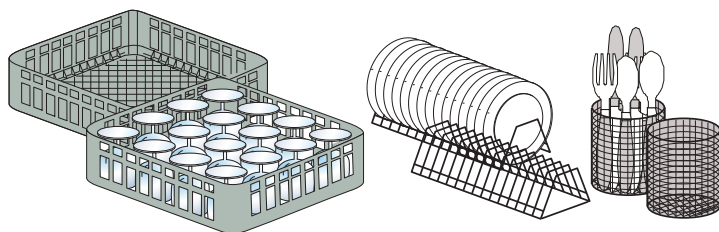

nr. 2 400x400 mm square glasses racks
nr. 1 cutlery basket
nr. 1 saucers holder

Option B)

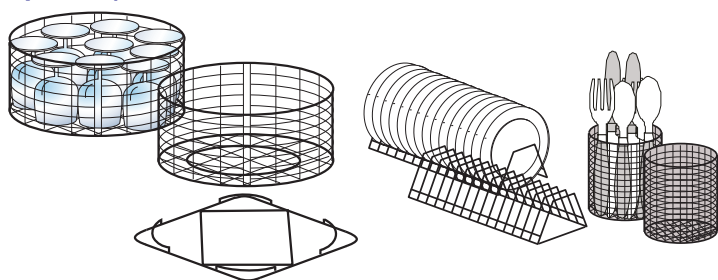

**nr. 2 round racks Ø 400 mm
nr. 1 support for round rack**

**nr. 1 cutlery basket
nr. 1 saucers holder**

**Standard equipment for machine with a 370x370 mm rack:
Option A)**

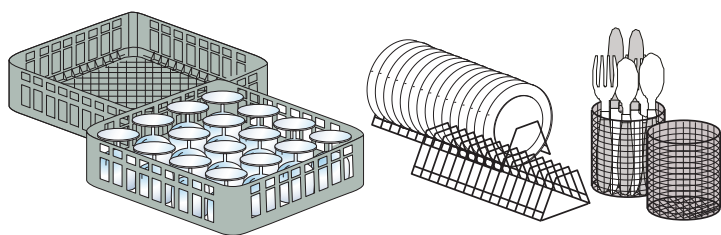

**nr. 2 370x370 mm square
glasses racks**

**nr. 1 cutlery basket
nr. 1 saucers holder**

Option B)

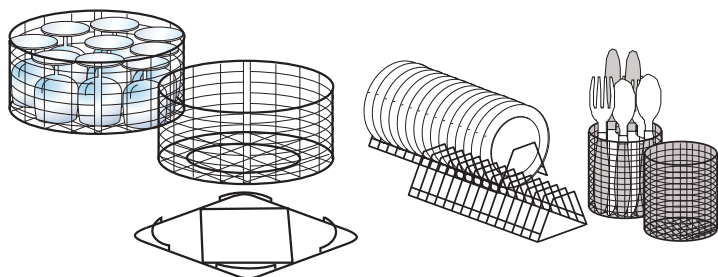

**nr. 2 Round racks Ø 370 mm
nr. 1 support for round rack**

**nr. 1 cutlery basket
nr. 1 saucers holder**

**Standard equipment for machine with a 350x350 mm rack:
Option A)**

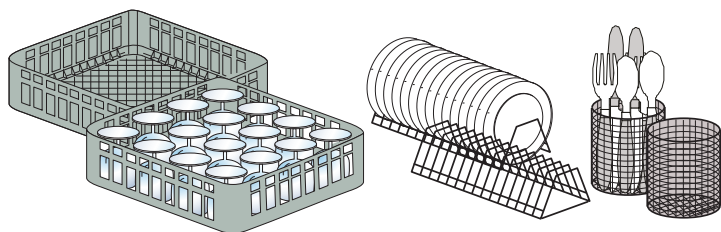

**nr. 2 350x350 mm square
glasses racks**

**nr. 1 cutlery basket
nr. 1 saucers holder**

Option B)

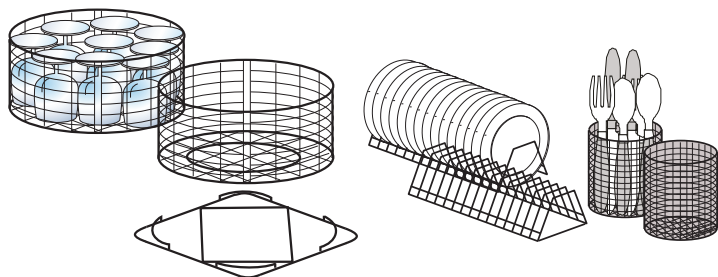

nr. 2 Round racks Ø 350 mm
nr. 1 support for round rack

nr. 1 cutlery basket
nr. 1 saucers holder

OPTIONAL:

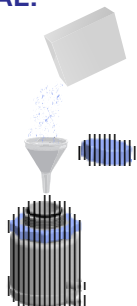

Water softener

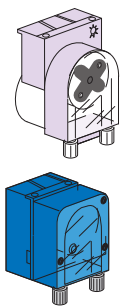

Detergent dispenser

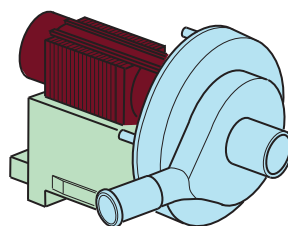







Drain pump

2.2 Machine features





The machine has a noise level below 65 dB(A).

3. CONTROL PANEL AND RELATIVE SYMBOLS

CONTROLS

-  1) Cycle START button
-  2) Main switch 0-1
-  3) Wash type selector
(if installed)
-  4) Drain pump button
(if installed)
-  5) Regeneration START button
(if installed)
-  6) Extra cold rinse key
(if installed)

INDICATORS

-  F1) Power on indicator
-  F2) Tank filling indicator
-  F3) Washing cycle indicator
-  F4) Regeneration cycle indicator
-  F5) Temperature indicator

4. OPERATION

- Check that the filter is correctly fitted in its seat (Pict. 1-Pict. 2).
- The filter must be cleaned after every 20 wash cycles and whenever necessary.
- **DO NOT use the appliance without the filter..**
- Insert the overflow tube in the special seat inside the tub (Pict. 1-Pict. 2).
- Close the dishwasher door.
- Insert the special rinse aid dispenser tube in the liquid container and check that the quantity of additive is sufficient for daily use (see paragr. 4.3 Use of rinse aid).
- Open the water tap and plug in the main switch.

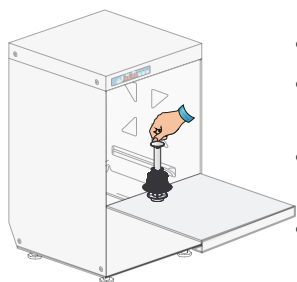

Pict. 1

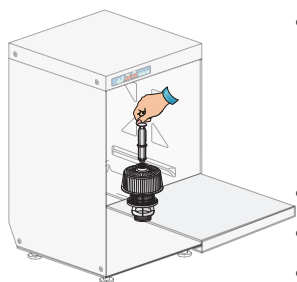

Pict. 2

- Turn switch **0-1** to position **1** (pressed). The operation is signalled by the switch indicator lighting up or by the indicator with the symbol **F1**. The machine will automatically fill the tub with water (indicator **F2** when present will turn on, indicating the tub is full).
- Should the machines be equipped with the WRAS certified Break Tank, the tank filling phase is extended.
- Then the heating phase begins. Indicator **F5** comes on when the water temperature is reached.
- Insert the rack filled with dishes to wash. The plates must be correctly placed in the rack (see paragr. 4.1 Cutlery and crockery loading).
- On machines with selector **3**, select the wash cycle required (see chap. 3. CONTROL PANEL AND RELATIVE SYMBOLS).
- Before starting the wash-cycle, in absence of an automatic dosing system, pour the detergent in the wash-tank.
- When the temperature indicator **F5** will turn on, press the **1 START** button for at least a second. The beginning of the cycle is indicated either by the light on the button itself or on the **F3** lamp.
- At the end of the washing cycle, a hot rinse cycle will take place.
- The indicator light of the **1 START** or the **F3** lamp will turn off when the cycle has finished (see chap. 3. CONTROL PANEL AND RELATIVE SYMBOLS).
- **Note:** At cycle end with the door closed, dishes do not get dried. Take out the basket or keep the door open to allow the evaporation and the drying of the dishes. To carry out a cooling glasses cycle, on appliances equipped with this option, press button **6** and hold it down for the desired length of time after the indicator light **F3** goes off. After this cycle, the glasses remain wet (see chap. 3. CONTROL PANEL AND RELATIVE SYMBOLS).
- The appliance is now ready for a new wash.
- At the end of the day, clean the machine (see chap. 5. MAINTENANCE).
- Turn off the machine and the water tap.
- Turn off the main wall switch.

4.1 Cutlery and crockery loading

Before cutlery and crockery loading in the machine, coarsely clean them from the leftover food. It isn't necessary to rinse the cutlery and crockery under water.



WARNING: Do not wash articles polluted with petrol, paint, chips of steel or iron, ash, sand, wax, lubricant grease. These substances damage the machine. Do not wash fragile objects or material not resistant to the washing process.

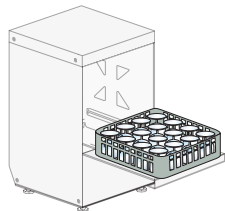

Note the following recommendations:

- Crockery and cutlery should not be inserted inside one another, covering each other.
- Place the crockery in order to all surfaces can be reached by water; otherwise the dishes are not washed.
- Make sure all the crockery are in a stable position and that the hollow containers don't overturn (cups, glasses, bowls, etc.).
- Place in the rack all the hollow containers such as cups, glass, etc. **upside-down**.
- Place the crockery with deep hollow with upper face downwards, so that water can flow out.
- Make sure the smaller crockery do not fall from the rack.
- Check all the wash arms runs freely and they are not blocked by too tall or too prominent crockery. Eventually, run a manual rotation of the arms to check it.

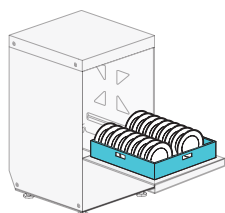

Pict. 3

Some foods, such as carrots, tomatoes, and others, may contain some natural dyes substances, that in large amounts, can alter the crockery and plastic parts colors.

Any discoloration does not mean that the plastic is not heat resistant.

Crockery and cutlery not suitable for dishwasher

Not suitable for dishwasher:

- Wooden crockery and cutlery or with wooden parts; water at high temperature causes deformation to wood. Also the adhesives used are not suitable for treatment in the dishwasher; a consequence could be the handles detachment.
- Crafts, precious vases or decorated glasses.
- Not heat-resistant plastic crockery.
- Copper, brass, pewter or aluminum objects: they may become discolored or opaque.
- The decorations on glass, after a certain number of washes, can lose gloss.
- Fragile glasses or crystal items, if often washed, can become opaque.

We recommend to buy exclusively crockery and cutlery suitable for dishwashing.

After several washes, the glass can become opaque.

It is mandatory to repeat the washing cycle if at the end of the cycle the crockery are not well clean or if there are washing residues (glasses, cups, bowls, etc. with liquid inside).

4.2 Use of detergent

By request the dishwasher can be equipped with an electric detergent dispenser (always recommended). If provided, the machine will automatically take the needed detergent amount.

The detergent must be of good quality, of NON-FOAMING type, specific for the mechanical washing of dishes.

The use of liquid detergents is recommended.

The dosing has to be done following the recommendations of the detergent manufacturer and in accordance with the water and dishes characteristics.

The detergent has to be inserted only in the wash tank. 1cm of the detergent drawn into the tube is equal to about 0,15 g. A correct amount of detergent is very important for a successful wash.

Note: It is forbidden to use detergents with chlorine-based reagents.

4.3 Use of rinse aid

It is possible to use the rinse aid to get quicker drying and polishing.

The machine is equipped with a rinse aid dispenser. The machine automatically draws the rinse aid chemical.

The dosing has to be done following the recommendations of the rinse aid manufacturer and in accordance with the water characteristics.

Note: Too much chemicals produces foam that reduces the effectiveness and lifetime of the washing pumps.

Too much chemicals might leave residuals on the dishes.

4.4 Regeneration device (optional)

Resin regeneration by the water softener is very important.

Resin regeneration: Resin regeneration should be carried out according to the number of cycles as indicated in the picture below Ex.: 27 °f (or 15 °d) = 39 cycles.

To carry out the purifying cycle, follow these instructions:

- Open the water tap and plug in the main switch.
- Turn the main switch **2** to 1 (ON) (see chap. 3. CONTROL PANEL AND RELATIVE SYMBOLS).
- Open the door.
- Remove the overflow tube and empty all the water in the tub.
- Once the tank is empty check and fully replenish the salt, being careful not to spill it on the tank itself. A strong concentration of salt can negatively affect the correct functioning and service life of the machine. Fill the special container, placed on the inside of the tub, with coarse salt (1-2 mm. grains - the maximum capacity of the bowl is 500 g. - see Pict. 4).
- Close the door, press button **5** for 5 seconds and wait for the cycle indicator **F4** to light up (see chap. 3. CONTROL PANEL AND RELATIVE SYMBOLS). The resins contained in the water softener will be automatically regenerated in about 20 minutes. The cycle is completed when the indicator light **F4** goes off.
- Wait 20 seconds before opening the door.
- After the softening cycle, switch the machine OFF (button **2** - see chap. 3. CONTROL PANEL AND RELATIVE SYMBOLS).
- Turn off the main wall switch.

Resin regeneration by the water softener is very important.

Resin regeneration: Resin regeneration should be carried out according to the number of cycles as indicated in the picture below Ex.: 27 °f (or 15 °d) = 39 cycles.

To carry out the purifying cycle, follow these instructions:

Pict. 4

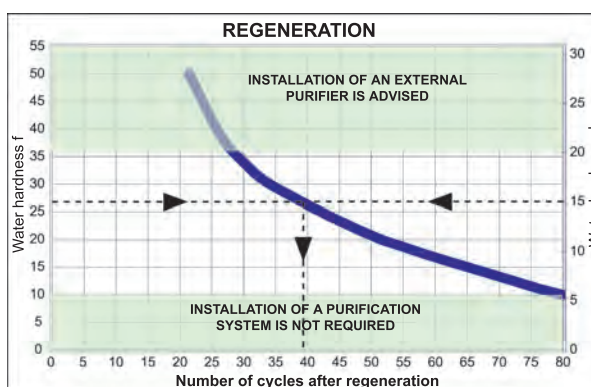
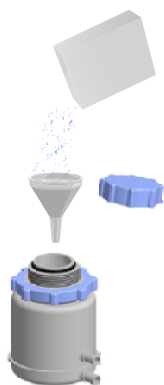

Note: Once the cycle has begun it cannot be stopped.

If a water conditioner is installed externally, follow the instructions given in the relative manual to regenerate the resins.

The flashing of the cycle lamp during the softening cycle, indicates a malfunction or a missed draining of the wash-tank (see chap. ALARMS).



WARNING: In the case of water hardness above 35 °f it is advisable to install an external water softener

4.5 Drain pump system (optional)

To drain completely the wash-tank keep the machine ON, extract the overflow pipe and shut the door. Press the button **4** for at least a second (see chap. 3. CONTROL PANEL AND RELATIVE SYMBOLS). The drain pump will automatically drain the wash-tank.

When the drain is completed, turn the machine OFF.

Turn the machine OFF and, after 5 seconds, ON by pressing the button **2** to fill the wash-tank and run a new cycle (see chap. 3. CONTROL PANEL AND RELATIVE SYMBOLS).

Opening the door will stop the machine that will re-start when the door is shut.

During the wash-rinse cycle the water in excess is automatically drained.

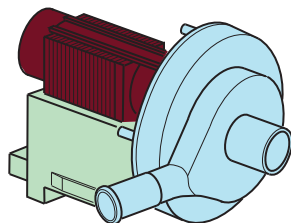

Pict. 5

4.6 Compliance with hygiene regulations and H.A.C.C.P.

- When starting the machine ON, no wash-cycle will be starting until the set boiler and wash-tank temperatures are reached. During operation, the machine will not start the rinse cycle till the set boiler temperature is reached.
- The machines are equipped with a temperature indicator **F5** which lights up when the boiler and the tub have reached the preset temperature (see chap. 3. CONTROL PANEL AND RELATIVE SYMBOLS - values set by the manufacturer). It is recommended to wait for this light to go on before starting the next cycle.
- Scrape food from the dishes carefully in order not to clog the filters, nozzles and pipes.
- Unload the wash tub and clean the filters at least twice a day.
- Check that the amount of detergent and rinse aid dispensed is correct (as suggested by the supplier of the product). In the morning, before starting the machine, check that the quantity of chemicals in the canisters is enough for daily supply.
- Always clean the support floor of the dishes.
- Extract the rack with clean hands or gloves to avoid finger marks.
- Do not dry or polish the dishes with non-sterilized cloths, brushes, or dusters.



5. MAINTENANCE



WARNING: The machine is not protected against water jets, therefore do not use pressure cleaning systems. Contact your cleaning products retailer for detailed instructions on the methods and products to use for periodic sanitizing of your appliance. **DO NOT** use bleach or chlorine-based detergents for cleaning the appliance.

5.1 Regular Maintenance

In order to ensure perfect performance, the appliance must be completely cleaned at least once a day in the following way::

- Turn the switch to 0 (see chap. 3. CONTROL PANEL AND RELATIVE SYMBOLS).
- Turn off the main wall switch.
- Turn off the water tap.
- Remove the overflow tube to empty the water. For appliances provided with emptying pump follow the indications as described on paragraph 4.5 Drain pump system (optional).
- Remove the filter and clean it with a brush under running water.
- Remove the rotors by loosening the fixing screws, and thoroughly clean the nozzles and cleaning and rinsing arms under running water
- If presents, remove the surface filters and clean it with a brush under running water (see Pict. 6).
- Bauen Sie alle Teile wieder ein, setzen Sie die Laufräder in ihre Sitze ein und befestigen Sie sie mit den entsprechenden Befestigungsschrauben Take extreme care to re-assemble the nozzles in the right position (open and / or closed nozzles) and that the arms are installed with the right axial angle.
- Clean the tub thoroughly using specific products.
- At the end of the day, it is advisable to leave the dishwasher door open.

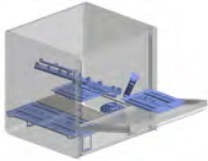

Pict. 6



Note: It is advisable to replace the tub water by refilling the tub at least every 20 wash cycles, or twice a day. Do not use metal brushes or corrosive products which can damage the machine.

5.2 Special Maintenance

Once or twice a year have a **qualified technician** inspect the machine:

- 1 Clean the electrovalve filter.
- 2 To remove residual deposits.
- 3 To check the watertight of the seals for water loading and unloading connections.
- 4 Check the perfect state and/or wear of the components. If a component is damaged or oxidized replace it immediately, with genuine spare parts only.
- 5 Check the efficiency of the dispensers
- 6 Check the efficiency of the door safety switch.
- 7 Tighten firmly all electrical connections.



Pay attention to do not wet the motor or any electric part.

Perform maintenance with the wall-mounted main switch turned OFF.

Every 3-4 years of machine use, double-check the tightening and the efficiency of all electrical contacts, with special attention to the contacts of starters and relays.

Increase controls frequency if the machine is operating in heavy or intensive conditions.



6. ALARMS

Alarms will be displayed by the lighting of LEDs. according to their typology.

TYPE OF ALARM	CAUSE	REMEDIES
Flashing of the cycle lamp	Missed refill of water in the wash-tank	Verify the full opening of the water inlet valve
		Verify the right positioning of the overflow pipe
		Switch the machine OFF and ON to reset the alarm
	Missed heating of the water boiler (in machines equipped with Thermostop)	Boiler thermostat out of order. Check them or call for Service
Boiler heating element out of order. Check them or call for Service		

7. ENVIRONMENTAL ASPECTS



7.1 Packing

The packing consists of the following:

- a wood pallet;
- a nylon bag (LDPE);
- multi-layered cardboard;
- polystyrene foam (PS);
- polypropylene support (PP).

All above materials, shall be disposed and treated in accordance with the Local Laws in force.



7.2 Disposal

The equipment is marked with the symbol (see **Pict. 7**).

The symbol indicates that the product should not be discarded as unsorted waste but must be sent to separate collection facilities for recovery and recycling in compliance with the legislation in force.

Pict. 7

An efficient waste disposal procedure contributes to avoiding any potential environmental or health hazards as well as promoting the recycling and re-utilization of materials from which our appliances are constructed.

If the user does not comply with the regulations he/she shall be subject to the penalties foreseen by each member state.

Disconnect electricity and water before disposal.

Cut the electrical cable to ensure that further use is impossible.

All metal parts are recyclable as they are made of stainless steel.

Recyclable plastic parts are marked with the plastic material symbol.



8. ECOLOGICAL ASPECTS

8.1 Recommendations for optimum use of energy, water and additives

Dispensing of salt: A pre-set quantity (by the manufacturer) of salt is injected in the resins every regeneration cycle. It is important to observe the number of regeneration cycles recommended in paragraph 4.4 Regeneration device (optional) in order to avoid salt spills or lime deposits.

If possible, use the machine at full load: This will avoid wasting detergent, rinse aid, water and energy.

Detergents and rinse aids: Use detergents and rinse aids having the highest biodegradability so that the environment is better respected. Have the correct dosage according to the water hardness checked at least once a year. An excess of product pollutes rivers and seas, whereas an insufficient amount compromises dish washing and/or hygiene.

Tank and boiler temperatures: The temperatures of the tank and boiler are set by the manufacturer so as to get the best washing results with the majority of detergents on the market. These can be reset by the installer according to the detergent used.

Cleaning off: Carefully clean off the kitchenware using water at ambient temperature with moderation so as to make removal of animal fats easier. To remove encrusted matter, soaking in hot water is recommended.

Notes: Wash the objects as soon as possible in order to prevent the deposits from drying and jeopardizing the effectiveness of the washing.

To get an efficient wash, it is advisable to regularly clean and maintain the dishwasher (see chap.5. MAINTENANCE).

Non-compliance with the above recommendations or with any and all information within the manual could result in a waste of energy, water, and detergent, further causing an increase in user costs and/or a reduction in performance.



9. TROUBLESHOOTING

Type of Problem	Possible Causes	Cure
The appliance does not start	The main switch is turned off	Turn on the switch
The appliance does not draw water	The water tap is closed	Open the water tap
	The rinsing arm nozzles or the electrovalve filter are clogged and/or caked with lime deposits	Clean the rinsing arm nozzles, the pipes and the electrovalve filter. If the machine has a water softener check the salt content or regenerate the resins more often
	Faulty pressure switch	Replace the pressure switch (call the Technical Assistance service)
Flashing of the cycle lamp	See chapter ALARMS	---
Unsatisfactory washing results	The washing nozzles are clogged or the washing arms do not rotate	Unscrew and clean the nozzles and the rotating column, refit them correctly in their seats
	Unremoved grease or starch	Detergent concentration too low
	The filter is too dirty	Remove the filter, clean it with a brush under running water and refit in its seat
	Check tank temperature (which must be between 50 °C and 60 °C).	Adjust the thermostat or check correct heating element operation
	Length of washing cycle inadequate for type of grime build-up	Choose a longer cycle if possible, otherwise repeat wash cycle
	Wash water too dirty	Empty water from the tub, clean filters; refill the tub and correctly reposition the filters
Presence of foam	Use of unsuitable products	Use non-foaming detergent or use less of same detergent
	Tub temperature too low	Adjust the thermostat or check correct heating element operation
Glasses or dishes are not completely dry	Insufficient rinse aid	Increase the amount of rinse aid by turning the screw on the dispenser (see paragraph Rinse aid dispenser)
	The rack is unsuitable for the glasses and dishes	Use a suitable rack enabling the dishes to be tilted so water can run off
	The dishes have been too long in the tub	As soon as the cycle stops, remove the rack with pots and tools so that they can dry more quickly in the air.
	Rinse water temperature is less than 75 °C - 80 °C	Check the temperature of the boiler thermostat
	Surface of dishes and glasses too rough or porous for material wear	Replace type of dishes and glasses used

Type of Problem	Possible Causes	Cure
Streaks and spots on glasses and dishes	Too much rinse aid	Decrease the amount of rinse aid by turning the fine-adjustment screw on the dispenser (see paragraph Rinse aid dispenser)
	The water is too hard	Check the water quality. Water must not exceed 8 °f (5 °d) in hardness.
	For appliances with conditioners: too little salt in the salt container or the resins have not been properly regenerated	Fill the salt container (coarse salt: 1-2 mm grains) and regenerate the resins more often. If lime deposits are also observed on the body of the machine, have a qualified technician check the operation of the water softener
	Salt present in dishwasher tub	Thoroughly clean and rinse the appliance, and avoid spilling salt when filling the container
The appliance suddenly stops during the cycle	The appliance is connected to an overloaded circuit	Connect the appliance separately (call the Technical Assistance service)
	A safety device has been activated	Check safety devices (call the Technical Assistance service)
During wash cycle the machine stops and draws water	Water from the previous day has not been replaced	Empty the tub and refill it
	The tub water temperature is too high	Have the Technical Assistance service check the thermostat and the pressure switch
	Faulty pressure switch	
minutes-> Min, day-> day, month-> Mon, year-> year).	The overflow tube is incorrectly positioned	Remove the overflow tube and correctly reposition it
	Little pressure on feeding	Take out the boiler pipe and drain the pump
The washing pump doesn't work	The pump is blocked	Call the Technical Assistance service

**Note:For any other problems, contact the Technical Assistance service.
The manufacturer reserves the right to alter the technical characteristics without prior notice.**

ORIGINAL INSTRUCTION

The following paragraphs amend the corresponding ones in the “Instructions for Use and Maintenance” and in the “Instructions for Installation and Maintenance” also supplied with the machine.

Please refer to the table of CONTENTS of those general Instructions.

Paragraph “Dataplate” or “Serial number data”

The diagram shows a dataplate with the following fields:

- UK CA CE
- Model Family: DWXXXX
- Model Code: DESCRIPTION
- S/N: DWX10XXXXX Type: IPXX
- 400V 3N 50HZ xxxxA
- xxxxW
- MAX xxx-xxx kPa
- MAX xx°C
- MAX xx°C xxxkPa
- RoHS
- MADE IN ITALY YYYY
- Model: [Barcode]
- S/N: [Barcode]

Callouts A-E point to specific fields:

- A: Power source (400V 3N 50HZ)
- B: Total power installed (xxxxW)
- C: Dynamic pressure (MAX xxx-xxx kPa)
- D: Envelope protection degree (IPXX)
- E: Total electricity absorption (xxxxW)

Legend for Model DW XXXX:

- FAMIGLIA PRODOTTO / FAMILY PRODUCT / FAMILLE DU PRODUIT / FAMILIA PRODUCTO / FAMILIE DES PRODUKTES / СЕРИЯ ПРОДКТА
- ANNO YEAR / ANNÉE / AÑO / JAHR / ГОД ВЫПУСКА: N=2017 - 2018, O=2018 - 2019, P=2019 - 2020, Q=xxxx - xxxx
- NUMERO DI SERIE / SERIAL NUMBER / NUMÉRO DI SÉRIE / NUMERO DI SERIE / SERIENNUMMER / СЕРИЙНЫЙ НОМЕР

Legend for S/N DW X xxxxxxxx:

- NUMERO DI SERIE / SERIAL NUMBER / NUMÉRO DI SÉRIE / NUMERO DI SERIE / SERIENNUMMER / СЕРИЙНЫЙ НОМЕР

- A** Power source
- B** Total power installed
- C** Dynamic pressure
- D** Envelope protection degree
- E** Total electricity absorption

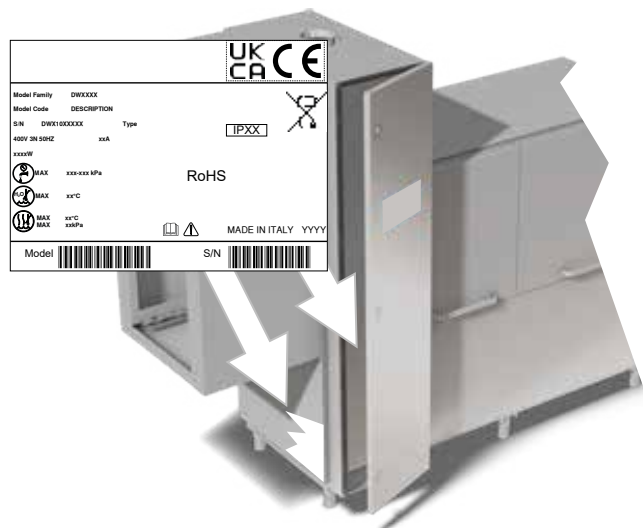
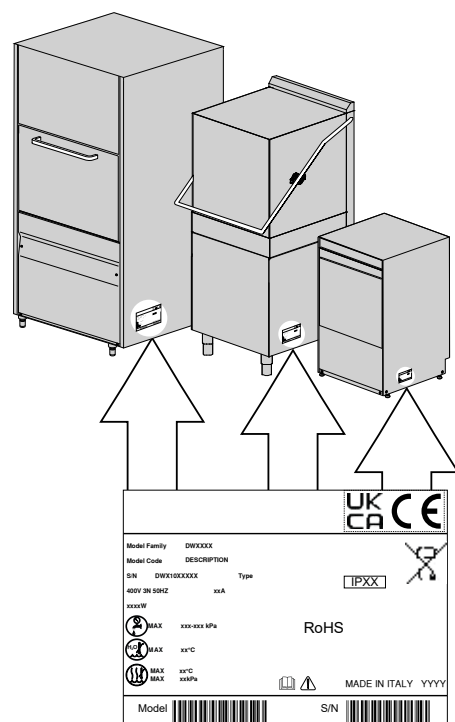
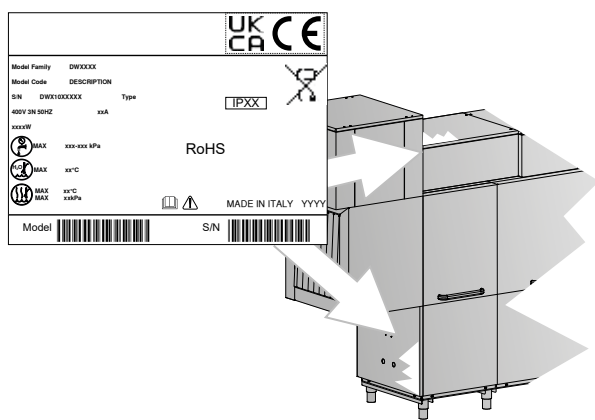

Paragraph “Water supply characteristics”

The machine water supply must be potable, in compliance with **The Water Supply (Water Quality) Regulations 2016**. The inlet water must also meet the parameters given in the table.

table

Water parameters table	Min	Max
Chlorine ¹		2 mg/l
pH	6,5 ¹	8,5 ³
Water hardness		8 °f ²⁻³
Iron ³		0,2 mg/l
Manganese ⁴		0,05 mg/l
Conductivity ⁵	200 µS/cm	

¹ Out of range values might lead to corrosion and jeopardize the life of the machine.

² Should the water hardness is higher **it is compulsory** to install a water softner and check periodically its operation.

³ Out of range values might lead scaling and sediments with a consequent lower performance, functionality, and expected life of the machine.

⁴ Desired value: Out of range values might lead stainless steel blackening/tarnishing.

⁵ For machines equipped with Heat Recovery System. Lower values are admitted only with stainless steel coils in the Heat Recovery System (optional).

It is recommended a water test once a year.

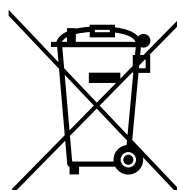

Paragraph “Disposal”

The symbol WEEE used on this product indicates that it cannot be treated as domestic waste. Proper disposal of this product contributes to protecting the environment. For more information on product recycling, contact the local authorities, domestic waste authorities or the dealer where the product was purchased.

For product or parts disposal, follow **The Restriction of the Use of Certain Hazardous Substances in Electrical and Electronic Equipment Regulations 2012** and **The Waste Electrical and Electronic Equipment Regulations 2013** as amended and/or application legislative decrees.

The present product or parts cannot be disposed of as urban waste but shall be collected in separate containers (see the waste bin on wheels symbol with an X on the product).

At the time of product disposal, the user shall refer to the waste electrical and electronic equipment (WEEE) specification. The manufacturer guarantees the absence of dangerous substances in the EEA used in conformity to **The Restriction of the Use of Certain Hazardous Substances in Electrical and Electronic Equipment Regulations**.

If the user does not comply with the regulations he/she shall be subject to the penalties foreseen by each member state.

Disconnect electricity and water before disposal.

Cut away the electrical cable to ensure that further use is impossible.

All metal parts are recyclable as they are made of stainless steel.

Recyclable plastic parts are marked with the plastic material symbol.

Paragraph “EU DECLARATION”

This paragraph does not apply.

Regulations, to which the machine you purchased complies with, are set forth in the UK Declaration of Conformity attached in original to the machine.