

5500E cod. USER

ed. 01 - 09/2022

EN - Use and maintenance manual



110765
110677

LEGGERE ATTENTAMENTE LE ISTRUZIONI PRIMA DI INSTALLARE LA MACCHINA

READ THE INSTRUCTIONS CAREFULLY BEFORE INSTALLING THE MACHINE

LIRE ATTENTIVEMENT LES INSTRUCTIONS AVANT D'INSTALLER LA MACHINE

LESEN SIE VOR DER INSTALLATION DES GERÄTES AUFMERKSAM DIE VORLIEGENDEN
GEBRAUCHSANLEITUNGEN

LEER ATENTAMENTE LAS INSTRUCCIONES ANTES DE INSTALAR LA MÁQUINA

ВНИМАТЕЛЬНО ПРОЧИТАЙТЕ ЭТИ ИНСТРУКЦИИ, ПРЕЖДЕ ЧЕМ ПРИСТУПАТЬ К УСТАНОВКЕ МАШИНЫ

LER ATENTAMENTE AS INSTRUÇÕES ANTES DE INSTALAR A MÁQUINA



TRANSLATION OF THE ORIGINAL INSTRUCTIONS

Contents	Page
WARNINGS	5
1. MACHINE INSTALLATION	6
1.1 Dataplate	6
1.2 Handling the product	7
1.3 Reception of the appliance	7
1.4 Storage	7
1.5 Machine equipment	7
1.6 Prepare for installation	7
1.7 Room features	7
1.8 Steam evacuation	7
1.9 Electrical connection - Characteristics	8
1.10 Water supply connection - Characteristics	8
1.11 Water supply characteristics	9
1.12 Connecting to a steam generator (special versions on request)	9
1.13 Positioning the machine	9
1.14 Electrical connection	10
1.15 Hydraulic connection	10
1.16 Starting	10
2. MACHINE DESCRIPTION	11
2.1 Machine description	11
2.2 Machine features	12
3. CONTROL PANEL AND RELATIVE SYMBOLS	13
4. OPERATION	14
4.1 Machine start-up	14
4.1.1 Start-up	14
4.1.2 Operation	14
4.1.3 Switching OFF	15
4.2 Objects loading	15
4.3 Use of detergent	16
4.4 Use of rinse aid	16
4.5 Tank draining	17
4.6 Emptying boiler and break tank (anti-freeze function)	17
4.7 Washing pumps	17
5. MAINTENANCE	18
5.1 Regular Maintenance	18
5.2 Special Maintenance	19
6. COMPLIANCE WITH HYGIENE REGULATIONS AND H.A.C.C.P.	19
7. ECOLOGICAL ASPECTS	19
7.1 Recommendations for optimum use of energy, water and additives	19
8. ENVIRONMENTAL ASPECTS	20
8.1 Packing	20
8.2 Disposal	20
9. SIGNALS AND ALARMS	21
9.1 Signals	21
9.1.1 Signals description	21
9.2 Alarms	21
9.2.1 Alarms description	22
10. TROUBLESHOOTING	23

WARNINGS



This instruction booklet must be kept with the dishwasher for future consultation. If the dishwasher is sold or transferred to another user, make sure the booklet always goes with the appliance so that the new owner can have the necessary information on operation and the relative instructions.

The user must comply with the following rules:

The instruction booklet must be carefully read before installation and first use of the dishwasher.

- Adaptation of the electrical and water systems for dishwasher installation must only be carried out by qualified operators.
- The user must not carry out any repair and/or maintenance operations. In any case contact qualified personnel.
- This dishwasher must only be used by adults. This is a professional machine to be used by qualified personnel, and installed and repaired exclusively by a qualified technical assistance service. The Manufacturer declines any responsibility for improper use, maintenance or repair.
- Only qualified personnel can access the control panel, when the main power switch is OFF.
- Servicing of this dishwasher must be performed by authorized personnel.

Note: Use original replacement parts only. Otherwise the product warranty is invalidated and the manufacturer is no longer responsible.

- This appliance can be used by trained youth aged from 15 years and above. It cannot be used by persons with reduced physical, sensory or mental capabilities or lack of experience and knowledge.
- Children shall not play with the appliance.
- Cleaning and user maintenance shall not be made by children without supervision.
- **Do not use old load pipe, but only new ones.**
- **This machine is designed exclusively for washing trays, baking-pans, food containers and pans in general with human food type of residue. DO NOT wash articles polluted with petrol, paint, bits of steel or iron, fragile objects or material not resistant to the washing process. Do not use acidic corrosive chemical products or alkaline and solvents or chlorine based detergents.**
- **It is necessary to install a suitable omni-polar automatic fuse switch sized according to the absorption that assures the complete disconnection from the network in an overvoltage category III condition.**
- **This switch must be incorporated in the supply network, dedicated only and exclusively to this circuit and installed in the immediate vicinity.**
- **The machine has to be absolutely turned off by this switch: only this switch gives the full warranty of complete detachment from the electric network.**
- **Make sure the appliance is linked to an efficient ground connection.**

-
- Do not open the machine door when operating. After switching the machine off, wait for at least 15 seconds after the motors stop.
 - Water infeed to the machine 400 kPa maximum.
 - Before using the machine, the personnel shall know the position of the emergency button, the position of the omni-polar switch that disconnected the machine from the electrical network, the position of the water connection shut-off valve and the procedures to switch off and secure the machine.
 - Only follow the instructions given in the manufacturer's booklet for cleaning operations (see chap. **5. MAINTENANCE**).

This machine must be disconnected from the main electrical supply after use at the end of the day and for any service/maintenance operation following this procedure: Switch the machine off from the control panel. Press the Drain Key on the control panel to drain the wash tank. Disconnect the electrical supply by the omni-polar switch (main switch located on the wall). Shut the water supply valve(s). Disregarding the aforesaid prescriptions is a serious misuse and can cause damages and injures to property and people, and will relieve the manufacturer from whatever liability.

- Do not use water to extinguish fires on electrical parts.
- Do not cover the intake or dissipation grids.
- Do not use any jets of water, high pressure or steam cleaning equipment, to clean the machine.

Note: The manufacturer declines any responsibility for accidents to people or any damage deriving from failure to observe the above listed instructions.



ATTENTION: DO NOT INSERT HANDS AND/OR TOUCH THE PARTS LOCATED AT THE BOTTOM OF THE WASH TANK AND/OR AT THE END OF THE WASH CYCLE.



WARNING: FAILURE TO COMPLY, EVEN PARTIALLY, WITH THE PRESCRIPTIONS IN THIS MANUAL WILL RENDER THE PRODUCT WARRANTY NULL, AND THE MANUFACTURER SHALL NOT BE LIABLE.

1. MACHINE INSTALLATION

1.1 Dataplate

- A Power source
- B Total power installed
- C Dynamic Pressure
- D Envelope protection degree
- E Total electricity absorption

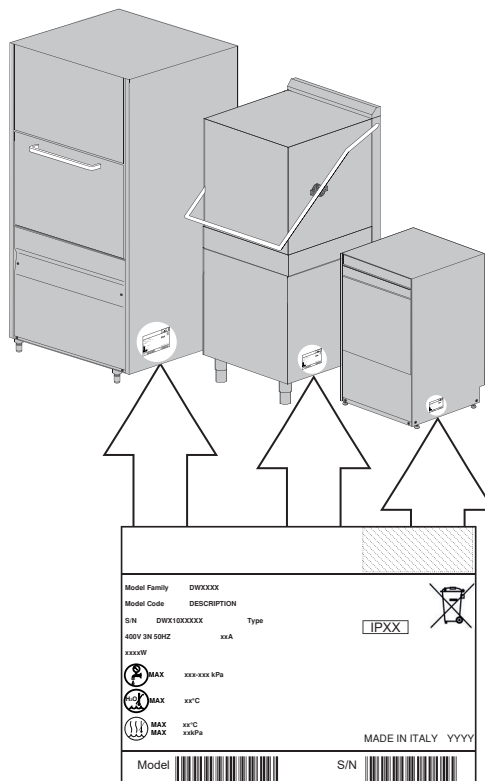
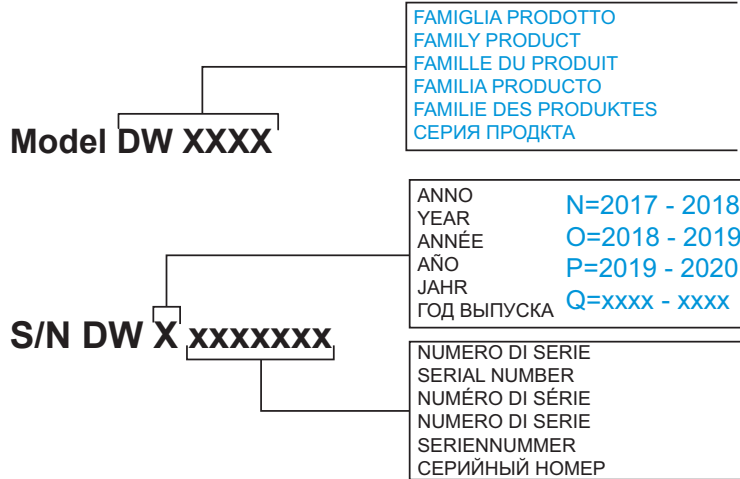
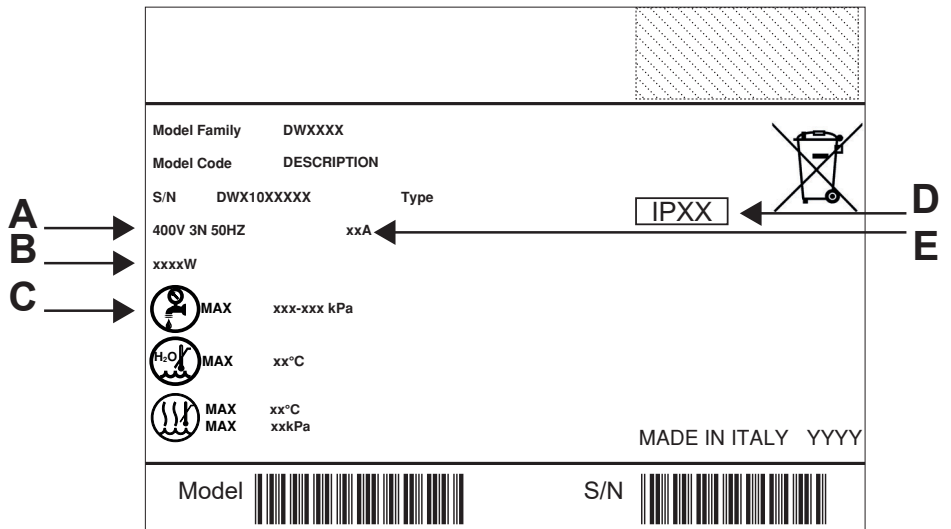

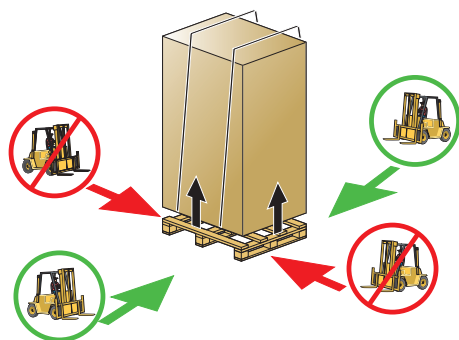

Pict. 1

1.2 Handling the product

The machine must be handled strictly as shown in **Pict. 1** regarding the grip points indicated for the lifting with a lift truck.

Latch the machine in a way that secures no vibrations or shocks during transportation.

Note: Slings with ropes not recommended.

1.3 Reception of the appliance

Before accepting the machine, verify that all the data on the data-plate corresponds to the required ones (see paragr. **1.1 Dataplate**) and to the ones of the available electrical supply.

After removing the packing, ensure that the appliance has not been damaged in transport. If it has, inform the retailer. If safety has been compromised, do not install the machine.

Double check the firm tightness of all hose-clamps on piping, nuts and bolts, and fasteners, that might come loose with the transport, to prevent water dripping or leakages, or other damages, during the machine's operation.

For disposal of the packing (see chap. **8.1 Packing**).

1.4 Storage

Storage temperature: min. +4 °C – max. +50 °C – humidity <90%.

The stored parts should be checked periodically to detect any sign of deterioration.

Do not store the machine exposing it to atmospheric agents (rain, sun, cold, etc.). Do not place material on the packed machine.

Do not rotate the machine in the storing phase (see **Pict. 2**).

Pict. 2

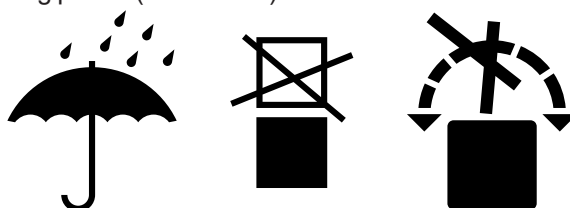

1.5 Machine equipment

Use and maintenance manual.

Wiring diagrams.

Plastic coated maintenance diagram.

A copy of the wiring diagrams must be kept inside the electrical board.

1.6 Prepare for installation

This is just a guide-line for the machine installation.

The installation must be performed by a qualified engineer.

1.7 Room features

Install the machine, in a room closed to weather and with a guaranteed temperature-range between 5 °C and 35 °C.

The machine is equipped with thermostatic sensors to manage the temperatures. To guarantee a proper functionality these sensor shall not operate at a room temperature below 5 °C.

For this reason, it is fundamental that before starting the machine reaches the room temperature.

1.8 Steam evacuation

In accordance with regulations of environmental hygiene, for the proper functioning of the machine and a healthy environment for the operator who working in there, it should be at least 10 air volume changes per hour in the room where the machine is installed.

For small wash rooms we recommend at least 15 air volume changes per hour.

If the machine is equipped with the Heat Recovery System (optional), the air-volume changes may be halved.

1.9 Electrical connection - Characteristics

Electrical connection must be carried out in compliance with the legislation in force and the relevant technical standards. Make sure that the supply voltage is the same as reported on the machine plate and that the network can stand the needed power absorption shown on the same plate.



It is necessary to install a suitable omni-polar automatic fuse switch sized according to the absorption that assures the complete disconnection from the network in an overvoltage category III condition. This switch must be incorporated in the supply network, dedicated only and exclusively to this circuit and installed in the immediate vicinity. The machine has to be absolutely turned off by this switch: only this switch gives the full warranty of complete detachment from the electric network. Make sure the appliance is linked to an efficient ground connection.



ATTENTION: Check very carefully if the “ground connection” of the machine is properly sized and fully efficient, and that not too many units are connected to it. An undersized or poor “ground connection” might lead to corrosion and/or pitting effect on the stainless steel plates, even to perforation.

1.10 Water supply connection - Characteristics

Water connections must be carried out in compliance with the legislation in force and the relevant technical standards. The water system must have characteristics between the parameters specified in **Tab. 1**

Tab. 1

Water characteristics table	Min	Max
Static Pressure	200 kPa	400 kPa
Dynamic Pressure*	150 kPa	350 kPa
Water hardness**	2 °f	8 °f
Cold water-supply temperature***	5 °C	50 °C
Hot water-supply temperature****	50 °C	60 °C
Capacity	10 l/min	

Connect the machine's water supply with an interrupt valve capable of quickly and completely shutting off water intake.

*If it is less than 2 bar dynamic pressure (200 kPa) a pressure pump **must be installed** to guarantee optimal machine operation (by request, the dishwasher can be supplied with a pump).

*If the water supply pressure is greater than 4 bar (400 kPa), a pressure reducing device **must be installed**.

For water with average hardness greater than 8°f, a water softener **must be used. This will result in cleaner dishes and longer life of the appliance.

Note: Any damage caused by limestone (calcareous water higher-up than 8 °f and without water-softener) will not be covered by warranty.

A periodical check of the supplied water hardness is highly recommended.

In order to ensure the optimum performance, the water supply temperature must come within the range given in table **Tab. 1**.

***Machines shall be made with extra power in case of cold water infeed.

The machine must be supplied with cold water (max 15 °C), if equipped with the Heat Recovery System. A hot water supply on that connection will not allow any energy recovery or steam reduction.



WARNING: Heat Recovery system and Steam Condenser - installation (optional)
It is strictly forbidden to connect the machine's vent directly with the outdoor!
Cold weather conditions might seriously damage the Thermal Recovery system or the Steam Condenser (outside temperatures).

****The water supply temperature shall never exceed 55 °C.

The emptying tube should always be connected to a siphon to prevent odor back-up from the screen.

Maximum drain height is cm. 15 (without optional drain pump).

1.11 Water supply characteristics

The machine water supply must be potable, in compliance with the legislation in force.
The inlet water must also meet the parameters given in the **Tab. 2**.

Tab. 2

Water parameters table	Min	Max
Chlorine ¹		2 mg/l
pH	6,5 ¹	8,5 ³
Water hardness		8 °f ²⁻³
Iron ³		0,2 mg/l
Manganese ⁴		0,05 mg/l
Conductivity ⁵	200µS/cm	

¹ Out of range values might lead to corrosion and jeopardize the life of the machine.

² Should the water hardness is higher it is compulsory to install a water softener and check periodically its operation.

³ Out of range values might lead scaling and sediments with a consequent lower performance, functionality, and expected life of the machine.

⁴ Desired value: Out of range values might lead stainless steel blackening/tarnishing.

⁵ For machines equipped with Heat Recovery System.

It is recommended a water test once a year.

1.12 Connecting to a steam generator (special versions on request)

Place a steam shut-off valve, nearby.

The inlet steam must also meet the parameters given in the **Tab. 3**.

Tab. 3

Pressure table/Steam supply	Min	Max
Static Pressure	0,5 bar	0,7 bar

If the steam pressure exceeds 0.7 bar, add a pressure reducer.

On the machine outlet, install a condense relief valve with a flow rate of at least 25 kg/h.

1.13 Positioning the machine

Remove the packing with care.

Lift the machine as described in chap. **1.2 Handling the product**.

Position the machine as shown on the installation diagram (lay-out) approved at the time of the offer.

Maintain a minimum distance of about 50 mm from the walls, so that motors are ventilated (see **Pict. 3**). Install suction hoods to assure proper ventilation of the room, in order to eliminate steam and excessive humidity.

Check that the machine is properly levelled, by adjusting the legs (see **Pict. 4**).

Make sure the machine is not standing on the power cable or on the filling/drain hoses. Level the machine by adjusting the support feet.

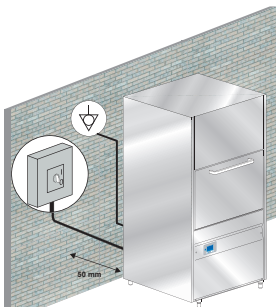

Pict. 3

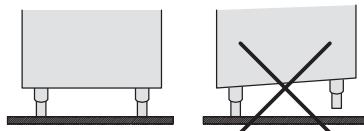

Pict. 4

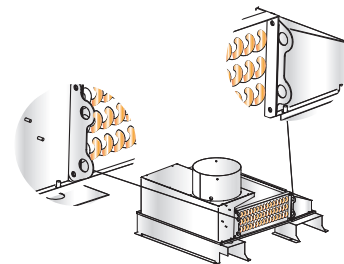

Pict. 5

In case of relocation of the machine, **DO NOT** use the lifting hooks of the heat exchanger (if installed) to lift the whole machine (see **Pict. 5**).

Those hooks are designed to bear the weight of the heat exchanger only, not the whole machine.

1.14 Electrical connection

Electrical connection must be carried out in compliance with the legislation in force and the relevant technical standards. Make sure that the voltage is the same as reported on the data-plate.

The machine is also provided with a terminal (marked with the symbol ) placed on the back end. It shall be used to bond different appliances via the external bonding conductor, in order to avoid the risk of electric shock.

The electrical supply cable must be new, flexible, and according to "har" H07RN-F or a local valid equivalent.

The cable size is dimensioned according to the power.

Should the electrical supply cable get damaged it shall be changed by the Manufacturer, or his Authorized Service, or other technician with equivalent qualification, to prevent any risk.

If the machine is fitted with a three-phase pump, check the correct motor rotation (right rotation as per arrow on the casing).

1.15 Hydraulic connection

Connect the water in-feed hose, given with the machine, to a ¾" water supply tap.

Warewasher: Connect the emptying tube, supplied with the appliance, to the union elbow located under the tub.

The emptying tube should always be connected to a siphon to prevent odor back-up from the screen.

To do in such a way that water flows freely (therefore ensuring a minimum slope). If the water cannot be discharged to a level below the machine drain, it is advisable to install a drain pump (supplied on request). Maximum drain height = cm. 31 .

1.16 Starting

At installation engineer's care.

2. MACHINE DESCRIPTION

2.1 Machine description

Wall-hung main power switch:
at installation
serviceman supply
and care, according to
local laws

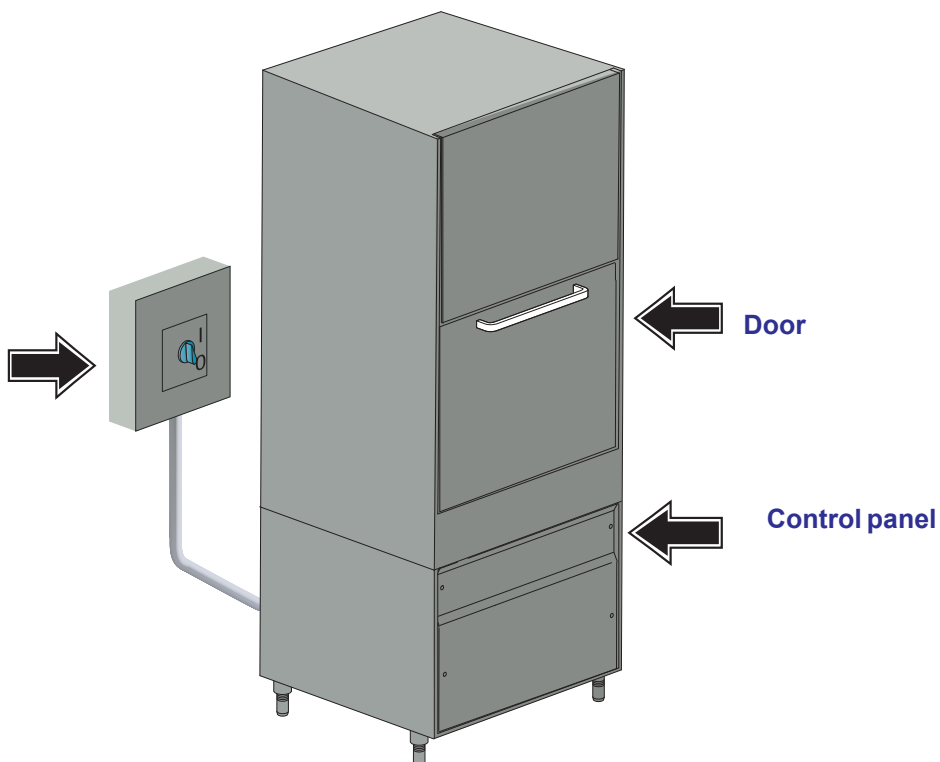

Standard equipment:



nr. 1 Stainless steel rack

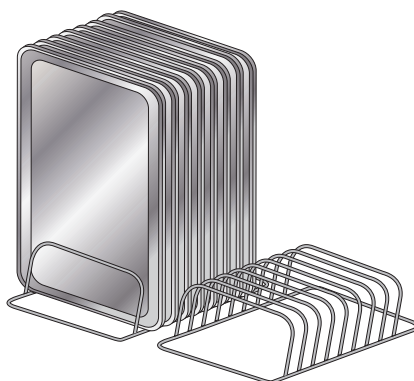

nr. 1 Trays support 8 pcs

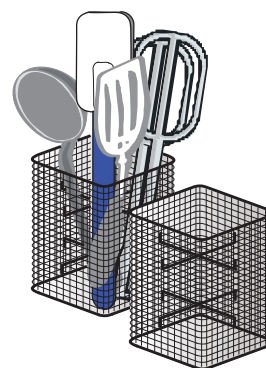

nr. 1 Inox spatulas rack



550x550mm grid

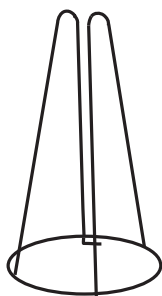

Sac à Poche support
(on machines equipped with
550 x 665 mm basket)

Optional:

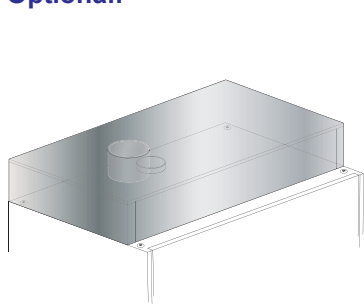

Heat Recovery

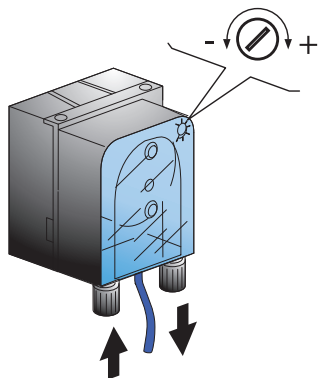

Detergent dispenser

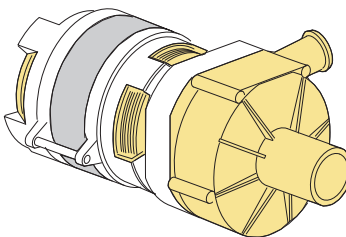

Drain Pump

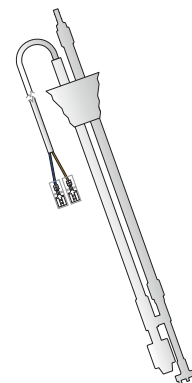

Probe lack detergent / rinse aid

To operate the machine, 3 connections are needed:

- Electrical;
- Water supply;
- Water drain;

This is a cycle machine comprising a 55 °C wash cycle with detergent, a 85 °C rinse cycle with injection of rinse-aid.

This machine is designed exclusively for washing trays, baking-pans, food containers and pans in general with human food type of residue.

Any other use is deemed improper.

Do not wash articles polluted with petrol, paint, chips of steel or iron, fragile objects or material not resistant to the washing process.

Do not use acidic corrosive chemical products or alkaline and solvents or chlorine based detergents.

Do not open the machine door when operating.

In any case, the machine has a special safety device which immediately stops the unit if the door is open, thus preventing water spillage

Always switch the machine completely off and drain the water tank, before accessing inside.



WARNING: Heat Recovery system and Steam Condenser - installation (optional)

It is strictly forbidden to connect the machine's vent directly with the outdoor!

Cold weather conditions might seriously damage the Thermal Recovery system or the Steam Condenser (outside temperatures).

2.2 Machine features

The machine's sound level is $LpA = 65\text{dBA} \pm 2.5$ (machine with 550 x 665 mm racks). **

The machine's sound level is $LpA = 70\text{dBA} \pm 2.5$ (machine with 700 x 700 mm racks). **

The machine's sound level is $LpA = 73\text{dBA} \pm 2.5$ (machine with 850 x 725 mm racks). **

The machine's sound level is $LpA = 74\text{dBA} \pm 2.5$ (machine with 1350 x 725 mm racks). **

** test made according to EN 60335-2-58/A11

3. CONTROL PANEL AND RELATIVE SYMBOLS

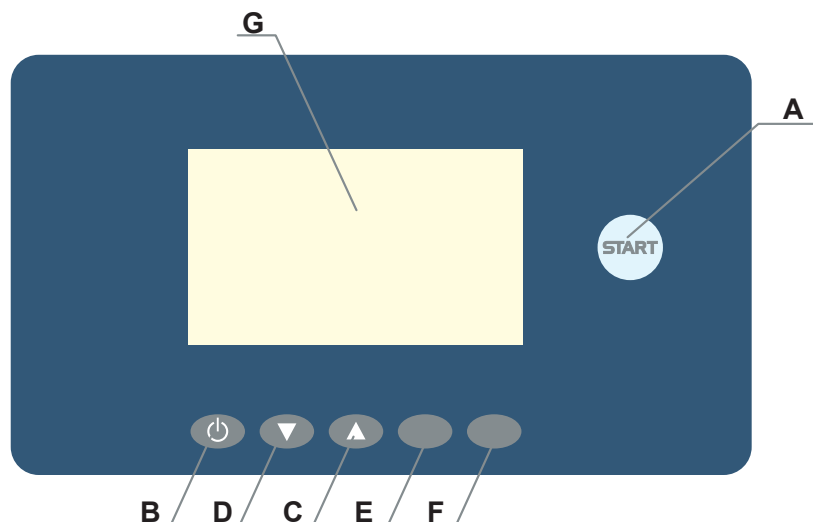

A: Cycle Start/Stop

Multi-chromatic button: Firm red light: machine filling/heating;
Flashing red light: alarm signal (check the code on the alarm chart);
Green light: machine ready. Select cycle;
Firm blue light: machine in operation;
Flashing blue light: machine in stand-by, anti-freeze function.

B: Machine power ON/OFF (in stand-by only)

C: Cycle Selection

D: Cycle Selection

E: Drain pump key (Optional)

F: Info

G: LCD Display

4. OPERATION

4.1 Machine start-up

4.1.1 Start-up

- Put the surface filters in place. **DO NOT use the appliance without the filters.**
- Close the dishwasher door.
- Open the water valve.
- Turn the main power switch ON. The message **Firmware** is displayed for a few seconds.
- The machine is on **stand-by**. The display will show **STAND-BY** or **LOGO**.
- Turn the button **B**.

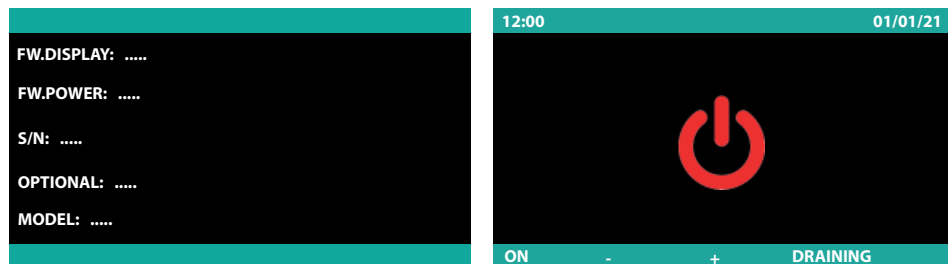

The machine start will be active when the **A** button will light.

On the display the **STAND-BY** message will be off.

The button **A** will light in white for a few seconds, while loading the software. After loading is complete, the button will light in red.

At this moment, the water filling starts. The display will read **FILLING WATER**.

Should the machines be equipped with the WRAS certified Break Tank, the tank filling phase is extended.

Once the filling is done, the heating phase will start. On the display will appear the reading **HEATING**. The reading will stay until both boiler and wash-tank will reach the set temperatures. During this process, the machine will not allow any cycle selection or start.

During this phase the **AUTOMATIC START** function can be enabled (see paragr. **4.1.2 Operation**).

After the filling/heating is completed, the key **A** and the display will turn green.

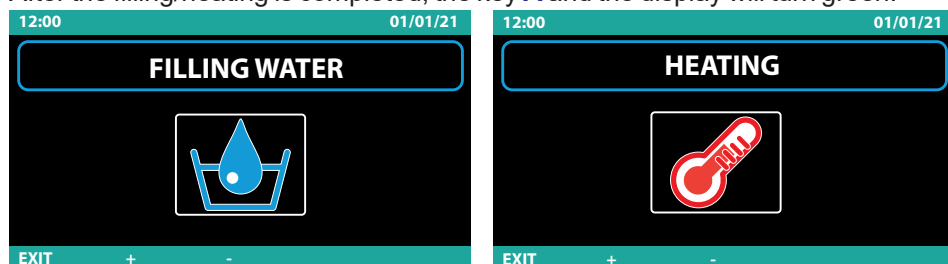

4.1.2 Operation

- Insert the rack filled with objects to wash (see paragr. **4.2 Objects loading**).
- Select the desired wash program by the keys **C** and **D** or by keeping pressed the **A** key. Release the key when the selected program is selected. To start the selected cycle press the **A** key. the button **A** will turn blue
- All wash-time long the display will read the wash-tank temperature and the boiler temperature.

Beneath the Temperatures Display will appear the Cycle Progress Bar (in percentage).

At the end of the washing cycle, a hot rinse cycle will take place.

A blue/green flashing on the button **A** will indicate the cycle ended.

The display shows **CYCLE ENDED** message.

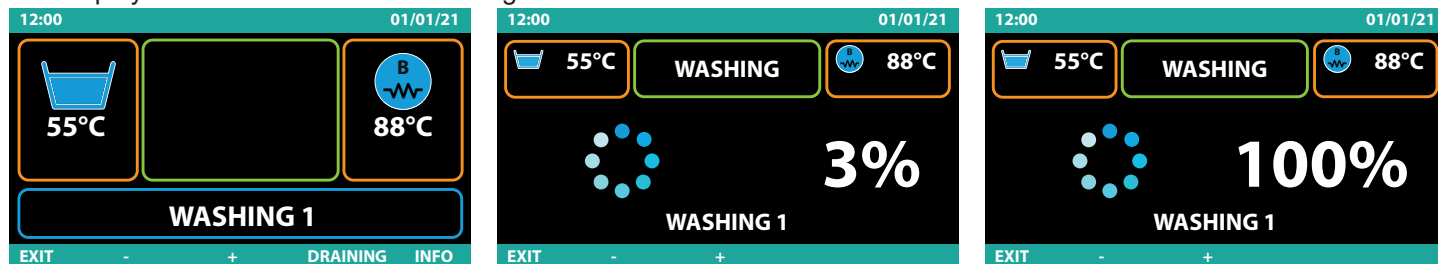

Note: At cycle-end, keeping the door closed, objects will not dry. Extract the rack or keep the door open to allow evaporation, helping the drying of the objects.

When opening the door, the button **A** will turn green, indicating that the machine is ready for a new wash-cycle.

Note: The last cycle used remain in the memory of the electronic board.

We recommend to change water at least twice a day, or whenever needed.

AUTOMATIC START: This function enables a self-activated wash cycle, when the filling/heating phase is completed.

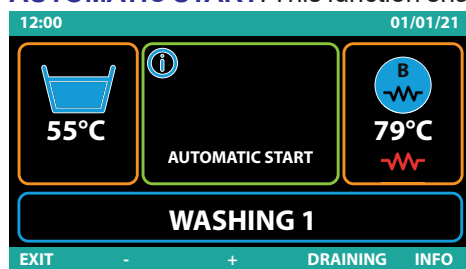

AUTOMATIC START activation:

- Keep pressed for 10 seconds the Key **A** during the filling or heating phase.
- Within 30 seconds select the wash cycle by pressing either **C** or **D** Keys and confirm by pressing **A**. The display will show **AUTOMATIC START**.
- If this does not happen, repeat the procedure.

4.1.3 Switching OFF

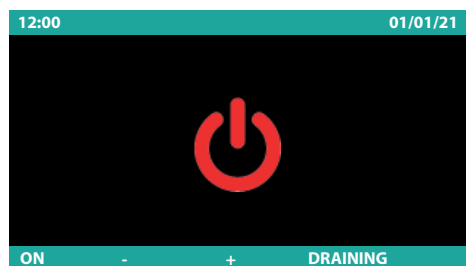

- Turn the button **B**. The display will show **STAND-BY** or **LOGO**.
- At the end of the day, clean the machine (see chap. **5. MAINTENANCE**).
- Shut the water valve.
- Turn off the main wall switch.
- At the end of the day, it is advisable to leave the dishwasher door open.

4.2 Objects loading

Before objects loading in the machine, coarsely clean them from the leftover food.

It isn't necessary to rinse the objects under water.



WARNING: Do not wash articles polluted with petrol, paint, chips of steel or iron, ash, sand, wax, lubricant grease. These substances damage the machine. Do not wash fragile objects or material not resistant to the washing process.

Note the following recommendations:

- Objects should not be inserted inside one another, covering each other.
- Place the objects in order to all surfaces can be reached by water; otherwise the objects are not washed.
- Make sure all the objects are in a stable position and that the hollow containers don't overturn (baskets, pots, pans, bowls, etc.) .
- Place in the rack all the hollow containers such as baskets, pots, pans, bowls, etc. **upside-down**.
- Place the objects with deep hollow with upper face downwards, so that water can flow out.
- Make sure the smaller objects do not fall from the rack.
- Check all the wash arms runs freely and they are not blocked by too tall or too prominent objects. Eventually, run a manual rotation of the arms to check it.

Some foods, such as carrots, tomatoes, and others, may contain some natural dyes substances, that in large amounts, can alter the objects and plastic parts colors.

Any discoloration does not mean that the plastic is not heat resistant.

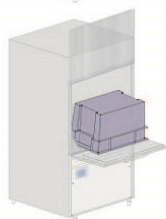

adjusted).

Not suitable for dishwasher:

- Wooden objects or with wooden parts; water at high temperature causes deformation to wood. Also the adhesives used are not suitable for treatment in the dishwasher; a consequence could be the handles detachment
- Crafts or precious vases
- Not heat-resistant plastic objects.
- Copper, brass, pewter or aluminum objects: they may become discolored or opaque.
- The decorations on glass, after a certain number of washes, can lose gloss.

We recommend to buy exclusively objects suitable for dishwashing.

It is mandatory to repeat the washing cycle if at the end of the cycle the objects are not well clean or if there are washing residues (baskets, pots, pans, bowls, etc. with liquid inside).

4.3 Use of detergent

The detergent must be of good quality, of NON-FOAMING type, specific for the mechanical washing of dishes.

By request the dishwasher can be equipped with an electric detergent dispenser (always recommended).

If provided, the machine will automatically take the needed detergent amount. 1 cm of the detergent drawn into the tube is equal to about 0,15 g.

Should the detergent lack, the display will show DETERGENT LEVEL (only with optional "Sensor for Chemicals Low Level").

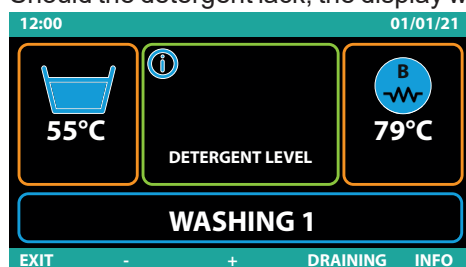

4.4 Use of rinse aid

It is possible to use the rinse aid to get quicker drying and polishing.

The dosing has to be done following the recommendations of the rinse aid manufacturer and in accordance with the water characteristics.

Note: Too much chemicals produces foam that reduces the effectiveness and lifetime of the washing pumps. Too much chemicals might leave residuals on the dishes.

The machine has a standard rinse aid dispenser. The machine automatically sucks the product.

Should the detergent lack, the display will show RINSE-AID LEVEL (only with optional "Sensor for Chemicals Low Level").

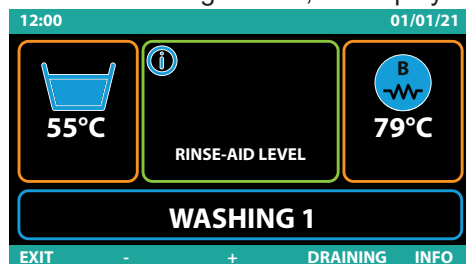

4.5 Tank draining

Press the key E till the display will show **TANK DRAINING**.

The machine can be equipped with discharge pump (optional).

During the drain process, the button **A** will light in blue and will be flashing.

After the draining is complete, the machine will turn automatically in **stand-by** mode.

If you want to refill the machine for a new cycle, (see paragr. **4.1 Machine start-up**).

The maximum permitted drain height cannot exceed 100 cm from the floor. The drain must be ahead of a trap.

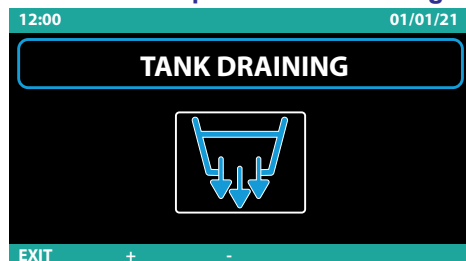

4.6 Emptying boiler and break tank (anti-freeze function)

This function permits the draining of the boiler and the break tank for any extraordinary maintenance or emptying function.

- Press key **B** and make sure that the tank is empty.
- Press the **A** button for 3 seconds and the boiler e break tank draining will activate. The message **SELF-CLEANING** will appear on the display and the **A** button will flash in blue light. Should the wash-tank be full, the system will not start the draining phase of the boiler and the display will show **DRAIN WATER IN WASH TANK**.
- Once emptying is complete, the machine can be turned back on with key **B**. This function occurs only with a boiler temperature over 50 °C.

4.7 Washing pumps

The washing pumps installed in the machine do not activate simultaneously, but one after the other with a few seconds delay. In this way, the electric peak is reduced.

Not available on machines with a 550 x 665 mm basket.

WARNINGS

- Do not put material or objects on the machine.
- The machine has an IP (see serial number label on the machine) protection rating against accidental water splashes and is not protected against pressurized water jets. Pressure-cleaning systems shall, therefore, not be used on this machine.
- Do not dip bare hands into water containing detergent. If this should occur, wash them immediately with plenty of water.
- Accompany the hood in opening and closing.
- Some important rules must be followed for using this appliance:



Never touch the appliance with wet hands or feet
Never use the appliance when barefoot
Do not install the appliance in places exposed to water sprays.
Do not cover the intake or dissipation grids.
Do not use water to extinguish fires on electrical parts.

This machine must be disconnected from the main electrical supply after use at the end of the day and for any service/maintenance operation. Switch off the main switch located on the wall, which shall be installed by a professional installer. Shut the water supply valve(s).

ATTENTION: INTERNAL CLEANING OF THE MACHINE SHALL BE CARRIED OUT AT LEAST 10 MINUTES AFTER THE POWER SWITCH HAS BEEN TURNED OFF.

ATTENTION: DO NOT INSERT HANDS AND/OR TOUCH THE PARTS LOCATED AT THE BOTTOM OF THE WASH TANK AND/OR AT THE END OF THE WASH CYCLE.

5. MAINTENANCE

WARNING: The machine is not protected against water jets, therefore do not use pressure cleaning systems. Contact your cleaning products retailer for detailed instructions on the methods and products to use for periodic sanitizing of your appliance.

DO NOT use bleach or chlorine-based detergents for cleaning the appliance.

5.1 Regular Maintenance

In order to ensure perfect performance, the appliance must be completely cleaned at least once a day in the following way:

- Turn the machine in **STAND-BY** mode, by pressing the push-button **B** of the control panel (see chap. **4. OPERATION**).
- Remove the surface filters and clean them under running water (see **Pict. 6**).
- Drain the sump water (see paragr. **4.1.3 Switching OFF**).
- Remove the rotors by loosening the fixing screws, and thoroughly clean the nozzles and cleaning and rinsing arms under running water (see **Pict. 7**).
- Remove the heat exchanger filter (if installed) and clean it under running water (see **Pict. 8**).
- Reassemble the parts and reposition the wash pipes. Take extreme care to re-assemble the nozzles in the right position (open and / or closed nozzles) and that the arms are installed with the right axial angle.
- Clean the tub thoroughly using specific products.
- At the end of the day, it is advisable to leave the dishwasher door open.
- **Automatic cycle of machine self-cleaning/rinsing:** recommended at each day end. With the machine on **STAND-BY** mode and, when the tank is empty, press the **A** key; an automatic cycle of 60 seconds will start, after this the machine will be in **STAND-BY** mode. !da duplicazione!
- Turn off the water tap.
- Turned off the machine by switching the main power switch OFF.



Pict. 6

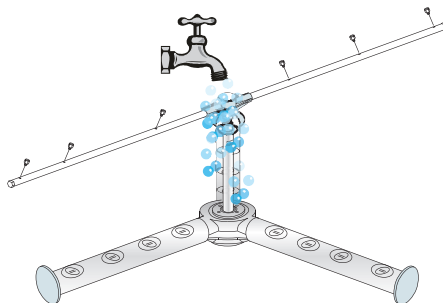

Pict. 7

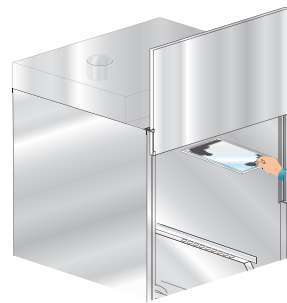

Pict. 8

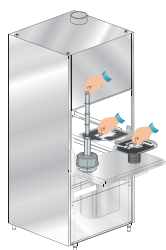

Pict. 9



Pict. 10

5.2 Special Maintenance

Once or twice a year have a **qualified technician** inspect the machine:

1 Clean the electrovalve filter.

2 To remove residual deposits.

3 To check the watertight of the seals for water loading and unloading connections.

4 Check the perfect state and/or wear of the components. If a component is damaged or oxidized replace it immediately with genuine spare parts only

5 Check the efficiency of the dispensers

6 Check the efficiency of the door safety switch.

7 Tighten firmly all electrical connections.

Pay attention to do not wet the motor or any electric part.

Perform maintenance with the wall-mounted main switch turned OFF.

Every 3-4 years of machine use, double-check the tightening and the efficiency of all electrical contacts, with special attention to the contacts of starters and relays.

Increase controls frequency if the machine is operating in heavy or intensive conditions.

6. COMPLIANCE WITH HYGIENE REGULATIONS AND H.A.C.C.P.

- When starting the machine ON, no wash-cycle will be starting until the set boiler and wash-tank temperatures are reached. During operation, the machine will not start the rinse cycle till the set boiler temperature is reached.
- Scrape food from the dishes carefully in order not to clog the filters, nozzles and pipes.
- Unload the wash tub and clean the filters at least twice a day.
- Check that the amount of detergent and rinse aid dispensed is correct (as suggested by the supplier of the product). In the morning, before starting the machine, check that the quantity of chemicals in the canisters is enough for daily supply.
- Always clean the support floor of the dishes.
- Extract the rack with clean hands or gloves to avoid finger marks.
- Do not dry or polish the dishes with non-sterilized cloths, brushes, or dusters.

7. ECOLOGICAL ASPECTS

7.1 Recommendations for optimum use of energy, water and additives

If possible, use the machine at full load: This will avoid wasting detergent, rinse aid, water and energy.

Detergents and rinse aids: Use detergents and rinse aids having the highest biodegradability so that the environment is better respected. Have the correct dosage according to the water hardness checked at least once a year. An excess of product pollutes rivers and seas, whereas an insufficient amount compromises dish washing and/or hygiene.

Tank and boiler temperatures: The temperatures of the tank and boiler are set by the manufacturer so as to get the best washing results with the majority of detergents on the market. These can be reset by the installer according to the detergent used..

Cleaning off: Carefully clean off the kitchenware using water at ambient temperature with moderation so as to make removal of animal fats easier. To remove encrusted matter, soaking in hot water is recommended.

Notes: Wash the objects as soon as possible in order to prevent the deposits from drying and jeopardizing the effectiveness of the washing.

To get an efficient wash, it is advisable to regularly clean and maintain the dishwasher (see chap. **5. MAINTENANCE**).

Non-compliance with the above recommendations or with any and all information within the manual could result in a waste of energy, water, and detergent, further causing an increase in user costs and/or a reduction in performance.

8. ENVIRONMENTAL ASPECTS

8.1 Packing

The packing consists of the following:

- a wood pallet;
- a nylon bag (LDPE);
- multi-layered cardboard;
- polystyrene foam (PS);
- polypropylene support (PP).

All above materials, shall be disposed and treated in accordance with the Local Laws in force.

8.2 Disposal

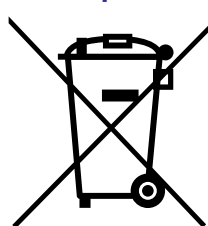

The equipment is marked with the symbol (see Pict. 11).

The symbol indicates that the product should not be discarded as unsorted waste but must be sent to separate collection facilities for recovery and recycling in compliance with the legislation in force.

An efficient waste disposal procedure contributes to avoiding any potential environmental or health hazards as well as promoting the recycling and re-utilization of materials from which our appliances are constructed. If the user does not comply with the regulations he/she shall be subject to the penalties foreseen by each member state.

Pict. 11

Disconnect electricity and water before disposal.

Cut the electrical cable to ensure that further use is impossible.

All metal parts are recyclable as they are made of stainless steel.

Recyclable plastic parts are marked with the plastic material symbol.

9. SIGNALS AND ALARMS

9.1 Signals



During the operation, the machine signals other situations in addition to alarms that need the operator attention.

In any case the relative information automatically appears on the display and remains visible until the operator execute the necessary actions.

9.1.1 Signals description

The signals messages are displayed, based upon their meaning.

When displaying **DETERGENT LEVEL** add detergent in the detergent tank (only with optional "Sensor for Chemicals Low Level").

When displaying **RINSE-AID LEVEL** add rinse-aid chemical in the rinse-aid tank (only with optional "Sensor for Chemicals Low Level").

When displaying **DOOR OPEN** means that the open door does not allow the maneuver tried, or a wash cycle was in progress, when lifting the door.

When the display shows **DRAIN VALVE OPEN** it indicates that the drain valve does not close.

Not available on machines with a 550 x 665 mm basket.

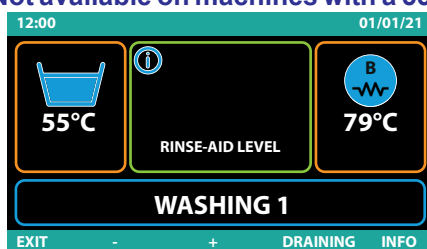

Signal screen example.



9.2 Alarms

The alarms are displayed on a dedicated screen that overlap the current display at the time the alarm occurs. Each alarm screen gives precise information about the meaning of the alarm and which are the operation the operator can run.

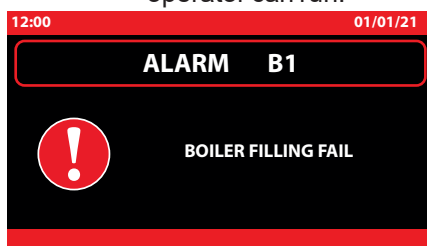

Alarm screen example.

9.2.1 Alarms description

TYPE OF ALARM	CAUSE	REMEDIES
B1	BOILER NOT FILLED	Open the water supply valve and verify a proper water supply flow. Contact Technical Service
B2	BOILER SENSOR FAILURE	Contact Technical Service
B3	BOILER NOT HEATED	Contact Technical Service
B4	FAILURE IN RINSING	Contact Technical Service
B5	BOILER OVERTEMPERATURE	Contact Technical Service
B9	BOILER SAFETY THERMOSTAT	Contact Technical Service
E1	WASH-TANK NOT FILLED	Open the water supply valve. Contact Technical Service
E2	WASH-TANK SENSOR FAILURE	Contact Technical Service
E3	WASH-TANK NOT HEATED	Contact Technical Service
E5	WASH-TANK OVERTEMPERATURE	Contact Technical Service
E6	TANK DRAINING FAILURE	Contact Technical Service
E7	WASH PUMP THERMAL RELAY 1	Contact Technical Service
E8	TANK SAFETY THERMOSTAT	Contact Technical Service
F7*	WASH PUMP THERMAL RELAY 2	Contact Technical Service
U3*	EXTRACTOR MOTOR THERMAL PROTECTION	Contact Technical Service
Z6	TANK LOW LEVEL:	Contact Technical Service

*Not available on machines with a 550 x 665 mm basket.

10. TROUBLESHOOTING

Type of Problem	Possible Causes	Cure
The appliance does not start	The main switch is turned off	Turn on the switch
The appliance does not draw water	The water tap is closed	Open the water tap
	Solenoid-valve filter blocked	Clean the filter
	Faulty pressure switch	Replace the pressure switch (call the Technical Assistance service)
Flashing of the cycle lamp	See chapter "Alarms"	---
Unsatisfactory washing results	The washing nozzles are clogged or the washing arms do not rotate	Unscrew and clean the nozzles and the rotating column, refit them correctly in their seats
	Unremoved grease or starch	Detergent concentration too low
	Presence of foam	Use non-foaming detergent or use less of same detergent
	The filter is too dirty	Remove the filter, clean it with a brush under running water and refit in its seat
	Check tank temperature (which must be between 50 °C and 60 °C).	Adjust the thermostat or check correct heating element operation
	Length of washing cycle inadequate for type of grime build-up	Choose a longer cycle if possible, otherwise repeat wash cycle
	Wash water too dirty	Empty water from the tub, clean filters; refill the tub and correctly reposition the filters
The objects are not properly dried.	Insufficient rinse aid	Increase the amount of rinse aid by turning the screw on the dispenser (see paragraph Rinse aid dispenser)
	The rack is not suitable for the objects.	Use the suitable rack which gives the objects an inclined position so that water can rinse away.
	The washed items may have been sitting in the wash chamber too long.	As soon as the cycle stops, remove the rack with the objects so that they can dry more quickly in the air.
	Rinse temperature under 80 °C.	Check the temperature of the boiler thermostat
	Surface of objects too rough or porous for material wear.	Replace type of the objects used.
Streaks and spots on glasses and dishes	Too much rinse aid	Decrease the amount of rinse aid by turning the fine-adjustment screw on the dispenser (see paragraph Rinse aid dispenser)
	The water is too hard	Check the water quality. Water must not exceed 8 °f (5 °d) in hardness
The appliance suddenly stops during the cycle	The appliance is connected to an overloaded circuit	Connect the appliance separately (call the Technical Assistance service)
	A safety device has been activated	Check safety devices (call the Technical Assistance service)
During wash cycle the machine stops and draws water	Water from the previous day has not been replaced	Empty the tub and refill it
	The tub water temperature is too high	Have the Technical Assistance service check the thermostat and the pressure switch
	Faulty pressure switch	
The washing pump doesn't work	The pump is blocked	Call the Technical Assistance service

Note: For any other problems, contact the Technical Assistance service.

The manufacturer reserves the right to alter the technical characteristics without prior notice.

ORIGINAL INSTRUCTION

The following paragraphs amend the corresponding ones in the “Instructions for Use and Maintenance” and in the “Instructions for Installation and Maintenance” also supplied with the machine.

Please refer to the table of CONTENTS of those general Instructions.

Paragraph “Dataplate” or “Serial number data”

A →

B →

C →

Model Family	DWXXXX		
Model Code	DESCRIPTION		
S/N	DWX10XXXXX	Type	
	400V 3N 50HZ	xxA	
	xxxxW		
	MAX	xxx-xxx kPa	RoHS
	MAX	xx°C	
	MAX	xx°C xxxPa	
Model		MADE IN ITALY YYY	

D ←

E ←

Model DW XXXX

S/N DW X XXXXXXXX

FAMIGLIA PRODOTTO	
FAMILY PRODUCT	
FAMILLE DU PRODUIT	
FAMILIA PRODUCTO	
FAMILIE DES PRODUKTES	
СЕРИЯ ПРОДКТА	
ANNO	N=2017 - 2018
YEAR	O=2018 - 2019
ANNÉE	
AÑO	P=2019 - 2020
JAHR	Q=XXXX - XXXX
ГОД ВЫПУСКА	
NUMERO DI SERIE	
SERIAL NUMBER	
NUMÉRO DI SÉRIE	
NUMERO DI SERIE	
SERIENNUMMER	
СЕРИЙНЫЙ НОМЕР	

- A Power source**
- B Total power installed**
- C Dynamic pressure**
- D Envelope protection degree**
- E Total electricity absorption**

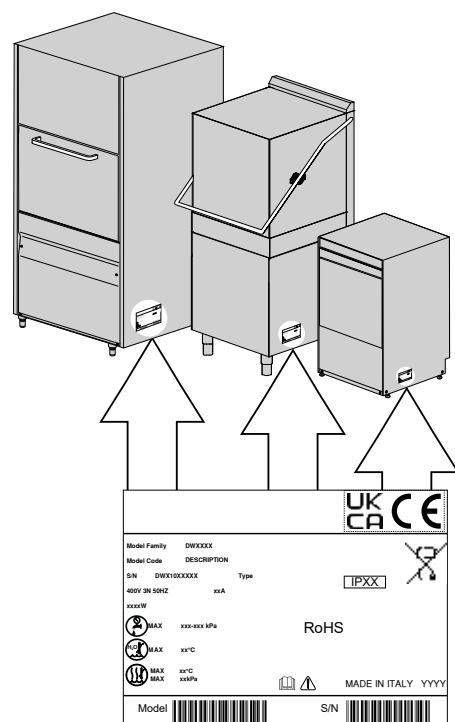
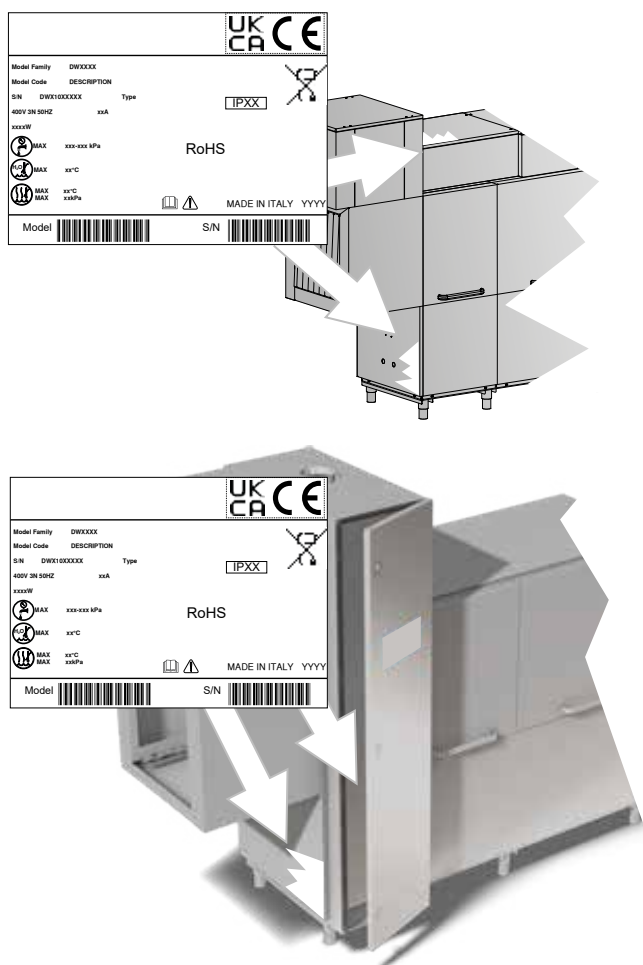

Paragraph “Water supply characteristics”

The machine water supply must be potable, in compliance with **The Water Supply (Water Quality) Regulations 2016**. The inlet water must also meet the parameters given in the table.

table

Water parameters table	Min	Max
Chlorine ¹		2 mg/l
pH	6,5 ¹	8,5 ³
Water hardness		8 °f ²⁻³
Iron ³		0,2 mg/l
Manganese ⁴		0,05 mg/l
Conductivity ⁵	200 µS/cm	

¹ Out of range values might lead to corrosion and jeopardize the life of the machine.

² Should the water hardness is higher **it is compulsory** to install a water softner and check periodically its operation.

³ Out of range values might lead scaling and sediments with a consequent lower performance, functionality, and expected life of the machine.

⁴ Desired value: Out of range values might lead stainless steel blackening/tarnishing.

⁵ For machines equipped with Heat Recovery System. Lower values are admitted only with stainless steel coils in the Heat Recovery System (optional).

It is recommended a water test once a year.

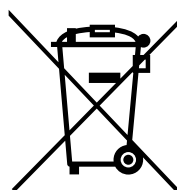

Paragraph “Disposal”

The symbol WEEE used on this product indicates that it cannot be treated as domestic waste. Proper disposal of this product contributes to protecting the environment. For more information on product recycling, contact the local authorities, domestic waste authorities or the dealer where the product was purchased.

For product or parts disposal, follow **The Restriction of the Use of Certain Hazardous Substances in Electrical and Electronic Equipment Regulations 2012** and **The Waste Electrical and Electronic Equipment Regulations 2013** as amended and/or application legislative decrees.

The present product or parts cannot be disposed of as urban waste but shall be collected in separate containers (see the waste bin on wheels symbol with an X on the product).

At the time of product disposal, the user shall refer to the waste electrical and electronic equipment (WEEE) specification. The manufacturer guarantees the absence of dangerous substances in the EEA used in conformity to **The Restriction of the Use of Certain Hazardous Substances in Electrical and Electronic Equipment Regulations**.

If the user does not comply with the regulations he/she shall be subject to the penalties foreseen by each member state.

Disconnect electricity and water before disposal.

Cut away the electrical cable to ensure that further use is impossible.

All metal parts are recyclable as they are made of stainless steel.

Recyclable plastic parts are marked with the plastic material symbol.

Paragraph “EU DECLARATION”

This paragraph does not apply.

Regulations, to which the machine you purchased complies with, are set forth in the UK Declaration of Conformity attached in original to the machine.