

RB=4000/3000W  
 MAIN CABLE 3X4mm<sup>2</sup>

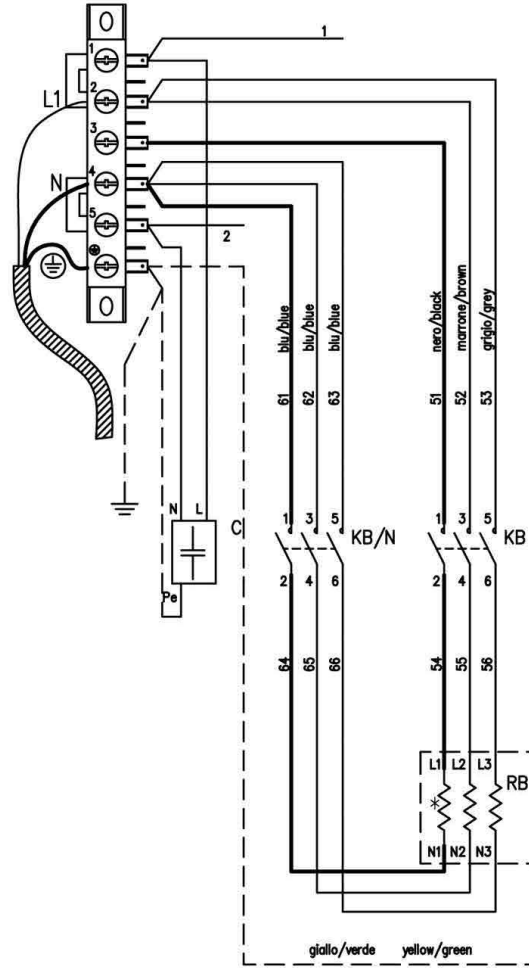

220-240 L1+N 50/60Hz

RB=2000/1500W  
 MAIN CABLE 3X4mm<sup>2</sup>

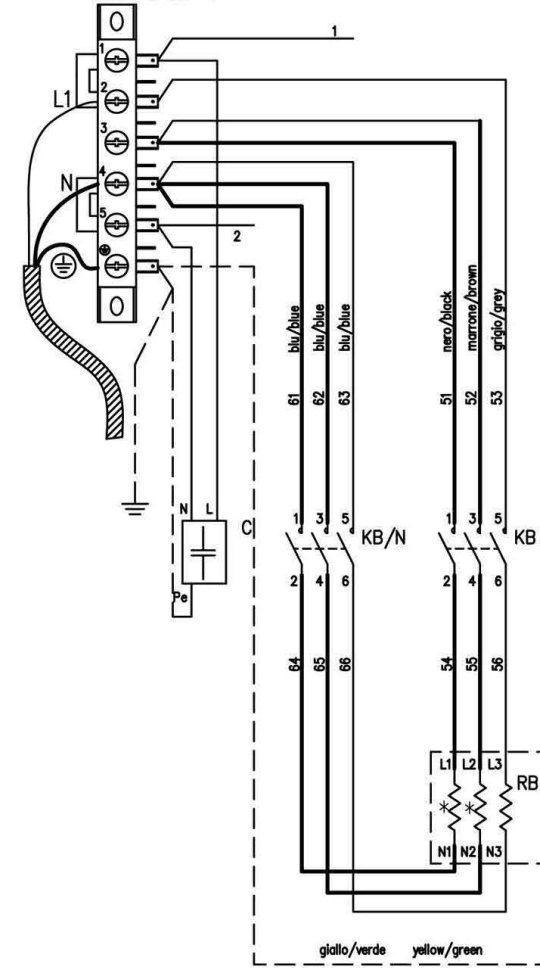

230 L1+N 50Hz

\* Element Disconnected

RB=6000/4500W  
MAIN CABLE 5X1.5mm<sup>2</sup>

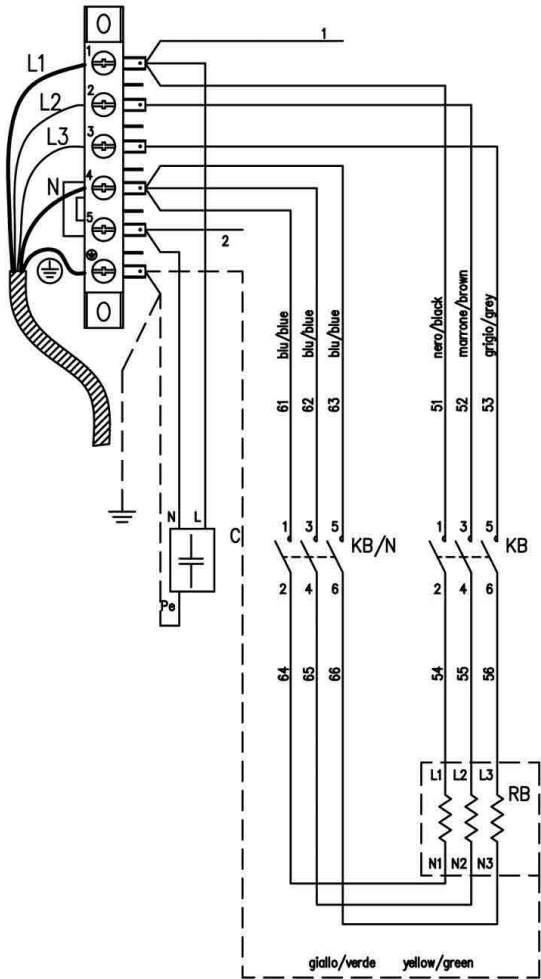

400-415 3P+N 50/60Hz

RB=6000/4500W  
MAIN CABLE 4X2.5mm<sup>2</sup>

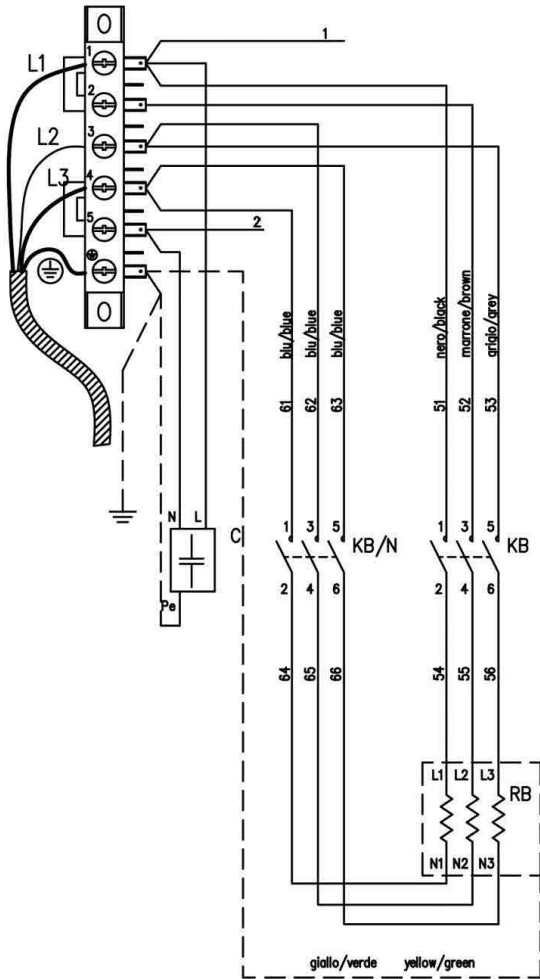

230-240 3P 50/60Hz

RB=6000/4500W  
MAIN CABLE 3X4mm<sup>2</sup>

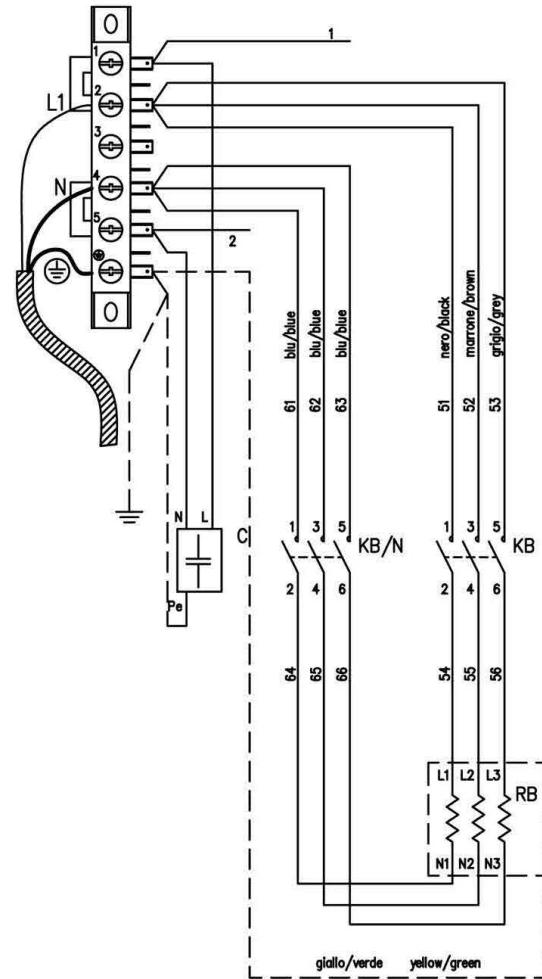

230-240 L1+N 50/60Hz

\* Element Disconnected

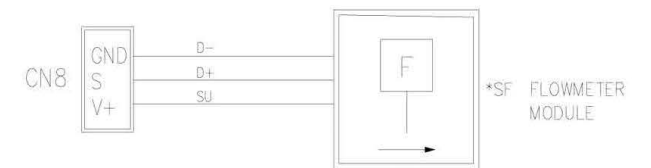
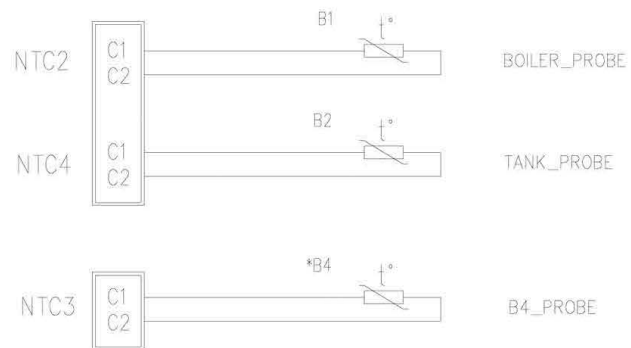
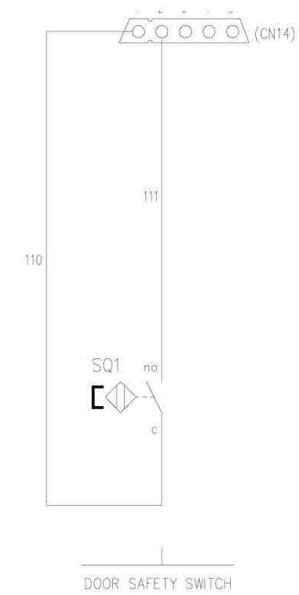
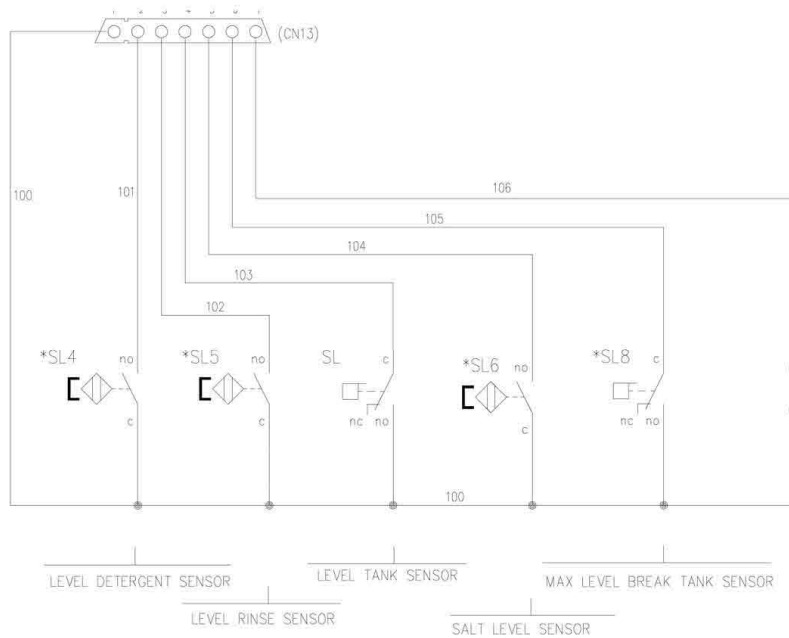

\*OPTIONAL

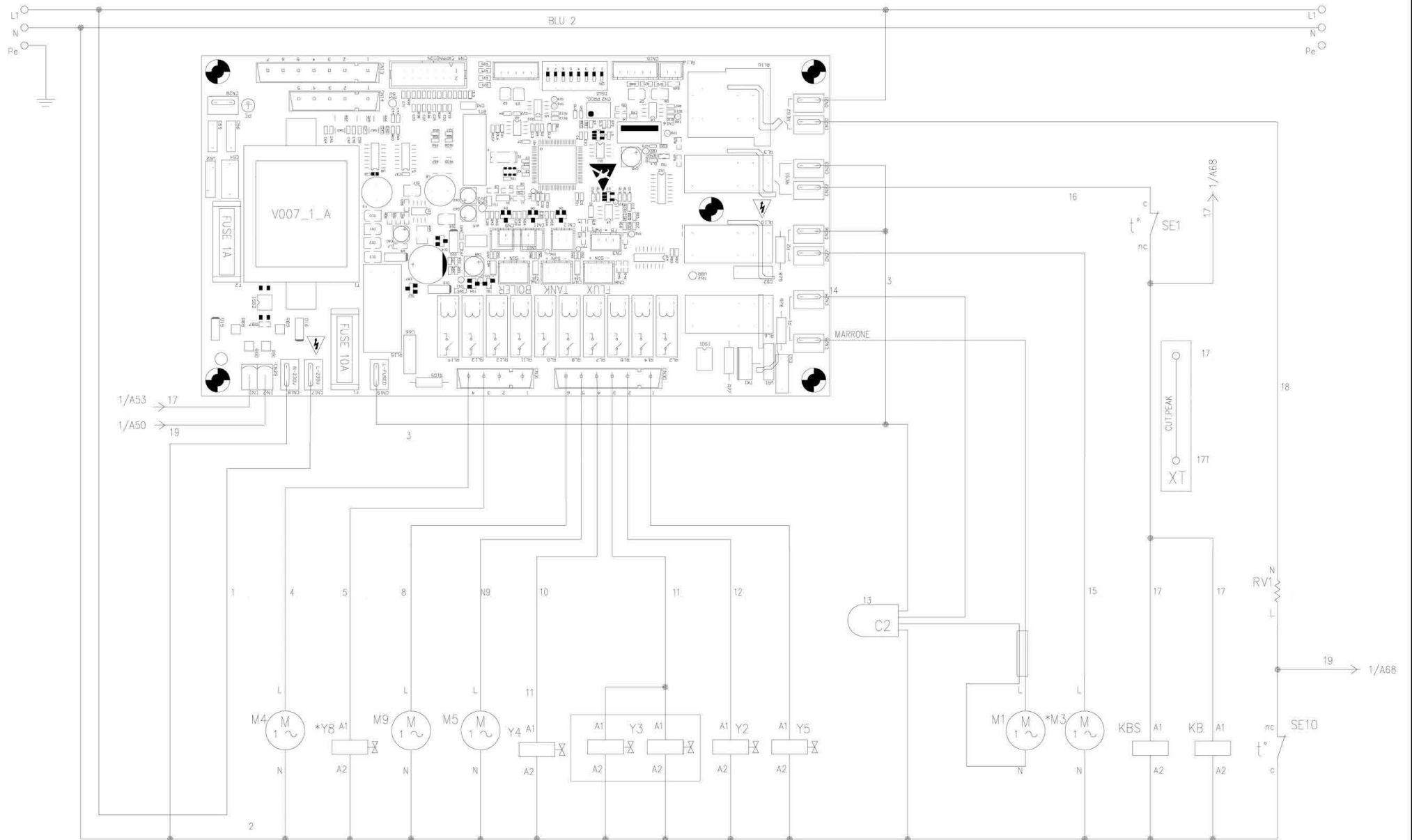

\*OPTIONAL

SKLA	ITALIANO	ENGLISH	FRANCAISE	TEDESCO	SPAGNOLLO
S3	PULSANTE SCARICO	DRAIN PUMP SWITCH	BOUTON POMPE DE VIDANGE	ENTLEERUNGSPUMPE-TASTE	BOTON DE DESCARGA
S4	PULSANTE INCREMENTA	BUTTON INCREASE	BOUTON AUGMENTE	ERHCHUNG-TASTE	BOTON DE AUMENTO
S5	PULSANTE -DECREMENTA	BUTTON DECREASE	BOUTON DIMINUE	VERKLEINERUNG-TASTE	BOTON DE DECREMENTO
S6	PULSANTE RISC. FREDDO	RINSE COLD WATER SWITCH	BOUTON DE RINCAGE FROID	KÄLTSPÜHLUNG-TASTE	BOTON ENJAGUE FROID
S7	PULSANTE CICLO INFINITO	UNLIMITED CYCLE PUSH BUTTON	BOUTON CYCLE SANS ARRÊT	PAUSELOSE ZYKLUS-START-TASTE	BOTON DE CICLO ILIMITADO
S8	PULSANTE PROGRAMMAZIONE	PROGRAMMATION SWITCH	BOUTON PROGRAMMATION	PROGRAMMSCHALTER	BOTON DE PROGRAMACION
S9	PULSANTE INFO	INFO BUTTON	BOUTON INFORMATION	INFORMATION	BOTON INFORMACION
SA1	INTERUTTORE GENERALE	MAIN SWITCH	INTERRUPTEUR GENERAL	HAUPTSCHALTER	INTERRUPTORES GENERAL
SA2	INTERUTTORE GENERALE-STAND BY	MAIN SWITCH STANDBY	INTERRUPTEUR GENERAL STANDBY	STAND-BY HAUPTSCHALTER	INTERRUPTORES GENERAL STAND-BY
SA3	SELETORE CICLO	PROGRAMMATION SWITCH	BOUTON PROGRAMMATION	PROGRAMMSCHALTER	SELECTOR DE CICLO
SE1	TERMOSTATO DI SICUREZZA BOLLER 1	SAFETY THERMOSTAT BOILER 1	THERMOSTAT BOILER DE SECURITE 1	SICHERHEITSTHERMOSTAT DES BOLLERS 1	TERMOSTATO DE SEGURIDAD CALDERIN 1
SE10	TERMOSTATO DI SICUREZZA VASCA 1	SAFETY TANK THERMOSTAT	THERMOSTAT DE SECURITE CUVE	SICHERHEITSTHERMOSTAT DER TANK	TERMOSTATO DE SEGURIDAD TANK 1
SE1F3	TERMOSTATO DI SICUREZZA BOLLER 1 3F	SAFETY THERMOSTAT BOILER 1 3F	THERMOSTAT BOILER DE SECURITE 3F	SICHERHEITSTHERMOSTAT DES BOLLERS 1 3F	TERMOSTATO DE SEGURIDAD CALDERIN 1 3F
SE2	TERMOSTATO DI SICUREZZA VASCA 1	SAFETY THERMOSTAT TANK 1	THERMOSTAT DE SECURITE CUVE 1 3F	SICHERHEITSTHERMOSTAT DER TANK 1	TERMOSTATO DE SEGURIDAD TANK 1
SF	FLUSSOSTATO	FLUSSOSTAT	FLUSSOSTAT	FLUSSMESSGERÄT	FLUJO
SL	SENSORE LIVELLO VASCA	LEVEL TANK SENSOR	PRESSOSTAT CUVE	TANKNIVEAUSENSOR	SENSOR DE NIVEL CUBA
SL1	SENSORE LIVELLO BOLLER	PRESSURE SWITCH BOILER	PRESSOSTAT BOILER	BOLLERNIVEAUSENSOR	SENSOR DE NIVEL CALDERIN
SL2	SENSORE LIVELLO BREAK TANK	BREAK TANK LEVEL SENSOR	CAPTEUR DE NIVEAU BREAK TANK	NIVEAUSENSOR FÜR BREAK TANK	SENSOR DE NIVEL BREAK TANK
SL3	SENSORE LIVELLO SICUREZZA	SECURITY LEVEL SENSOR	CAPTEUR DE NIVEAU DE SECURITE	SICHERHEITSNIVEAUSENSOR	SENSOR DE NIVEL SEGURIDAD
SL4	SENSORE LIVELLO DETERGIVO	LEVEL DETERGENT SENSOR	CAPTEUR DE NIVEAU PRODUIT LAVAGE	NIVEAUSENSOR FÜR WASCHMITTEL	SENSOR DE NIVEL DOSIFICADOR DE JABON
SL5	SENSORE LIVELLO BRILLANTANTE	LEVEL RINSE SENSOR	CAPTEUR DE NIVEAU PRODUIT RINCAGE	NIVEAUSENSOR FÜR SPÜLMITTEL	SENSOR DE NIVEL DOSIFICADOR DE ABRILLANTADOR
SL6	SENSORE LIVELLO SALE	SALT LEVEL	CAPTEUR DE NIVEAU DU SEL	NIVEAUSENSOR FÜR SALZ	SENSOR DE NIVEL SAL
SL7	SENSORE LIVELLO TANK LIFT	LEVEL LIFT TANK SENSOR	CAPTEUR DE NIVEAU TANK LIFT	NIVEAUSENSOR FÜR LIFT TANK	SENSOR DE NIVEL LIFT TANK
SL8	SENSORE LIVELLO BREAK TANK	LEVEL BREAK TANK SENSOR	CAPTEUR DE NIVEAU BREAK TANK	NIVEAUSENSOR FÜR BREAK TANK	SENSOR DE NIVEL BREAK TANK
SL9	SENSORE LIVELLO SANITIZZANTE	SANITIZER LEVEL SENSOR	CAPTEUR NIVEAU ASSAINISSEMENT	NIVEAUSENSOR SANITISATIONSMITTEL	SENSOR DE NIVEL SANEAMIENTO
SP1	SENSORE PRESSIONE RETE	NETWORK PRESSURE SENSOR	CAPTEUR PRESSION HYDRAULIQUE	WASSERDRUCKSENSOR	SENSOR PRESSION HIDRAULICA
SP2	SENSORE PRESSIONE POMPA M1	PRESSURE SENSOR PUMP M1	CAPTEUR PRESSION POMPE M1	DRUCKSCHALTER PUMPE M1	SENSOR PRESSION BOMBA M1
SP3	SENSORE PRESSIONE POMPA M1A	PRESSURE SENSOR PUMP M1 A	CAPTEUR PRESSION POMPE M1A	DRUCKSCHALTER PUMPE M1 A	SENSOR PRESSION BOMBA M1A
SP4	SENSORE PRESSIONE POMPA M2	PRESSURE SENSOR PUMP M2	CAPTEUR PRESSION POMPE M2	DRUCKSCHALTER PUMPE M2	SENSOR PRESSION BOMBA M2
SP5	SENSORE PRESSIONE POMPA M2A	PRESSURE SENSOR PUMP M2 A	CAPTEUR PRESSION POMPE M2A	DRUCKSCHALTER PUMPE M2 A	SENSOR PRESSION BOMBA M2A
SPV	SENSORE VACUOSTATO	VACUUM SWITCH SENSOR	CAPTEUR VACUOSTAT	VAKUUMMETER SENSOR	SENSOR VACUOSTATO
SQ1 A-B-C	SENSORE FINECORSA PORTA	DOOR SAFETY SWITCH	CAPTEUR MICRO SECURITE PORTE	TÜR-KONTAKT	SENSOR FINAL DE CARRERA PUERTA
SQ2	SENSORE FILTRO	FILTER SWITCH	CAPTEUR FILTRE	FILTER-SENSOR	SENSOR FILTRO
SR1-8	SENSORE ROTATIVO 1-8	SENSOR ROTARY 1-8	CAPTEUR ROTATIF 1-8	SENSOR ROTARY 1-8	SENSOR DE ROTARY 1-8
ST1	TERMOSTATO BOLLER 1	BOILER THERMOSTAT	THERMOSTAT SURCHAUFFEUR	BOILERTHERMOSTAT 1	TERMOSTATO CALDERIN 1
ST10	TERMOSTATO VASCA 1	TANK THERMOSTAT	THERMOSTAT CUVE	TANKTHERMOSTAT 1	TERMOSTATO CUBA 1
TA 1	TRASFORMATORE	TRANSFORMER	TRANSFORMATEUR	TRANSFORMATOR	TRANSFORMADOR
UV	LAMPADA UV	LAMP UV	LAMPE UV	UV-LAMPE	LAMPARA UV
Y1	ELETTROVALVOLA RIEMPIIMENTO VASCA	LOAD SOLENOID VALVE	ELECTROVANNE CHARGEMENT CUVE	MAGNETVENTIL FÜR TANKFÜLLUNG	ELECTROVALVULA CARGA CUBA
Y2	ELETTROVALVOLA SALAMOIA	REGENERATION SOLENOID VALVE	ELECTROVANNE REGENERATION	MAGNETVENTIL FÜR REGENERATION	ELECTROVALVULA REGENERACION
Y3	ELETTROVALVOLA SCARICO SALAMOIA	DRAIN SOLENOID VALVE	ELECTROVANNE VIDANGE	ENTLEERUNGS-MAGNETVENTIL	ELECTROVALVULA DESCARGUE REGENERACION
Y4	ELETTROVALVOLA RISC. FREDDO	RINSE COLD WATER SOLENOID VALVE	ELECTROVANNE RINCAGE FROID	KÄLTWASSERSPÜLLUNG-MAGNETVENTIL	ELECTROVALVULA ENJAGUE FROID
Y5	ELETTROVALVOLA RIEMPIIMENTO BOLLER	LOAD BOILER SOLENOID VALVE	ELECTROVANNE CHARGEMENT SURCHAUFFEUR	MAGNETVENTIL FÜR BOILERFÜLLUNG	ELECTROVALVULA CARGA CALDERIN
Y6	ELETTROVALVOLA LAVAGGIO CONDENSATORE	CONDENSER CLEANING SOLENOID VALVE	ELECTROVANNE NETTOYAGE CONDENSEUR	MAGNETVENTIL KONDENSATORREINIGUNG	ELECTROVALVULA LIMPIAR CONDENSADOR
Y7	ELETTROVALVOLA LIFT	SOLENOID VALVE LIFT	ELECTROVANNE LIFT	LIFT MAGNETVENTIL	ELECTROVALVULA LIFT
Y8	ELETTROVALVOLA BREAK TANK	SOLENOID VALVE BREAK TANK	ELECTROVANNE BREAK TANK	BREAK TANK MAGNETVENTIL	ELECTROVALVULA BREAK TANK
Y9	ELETTROVALVOLA CONDENSAZIONE	MAIN SOLENOID VALVE	ELECTROVANNE CONDENSATION	HAUPTMAGNETVENTIL	SOLENOIDE DE CONDENSACION
Y10	ELETTROVALVOLA RIGENERAZIONE CA.POTTE	Y10 HOOD TYPE REGENERATION SOLENOID VALVE	Y10 ELECTROVANNE REGENERATION MACHINE A CAPOT	Y10 MAGNETVENTIL REGENERIERUNG HAUBENMASCHINE	Y10 ELECTROVALVULA REGENERACION CUPULA
YG	ELETTROVALVOLA GENERALE	MAIN SOLENOID VALVE	ELECTROVANNE GENERALE	HAUPTMAGNETVENTIL	SOLENOIDE GENERAL
YM	ELETTROVALVOLA MOTORIZZATA GRANULI	MOTORIZED GRANULES SOLENOID VALVE	ELECTROVANNE MOTORISE GRANULES	MOTORISIERTES MAGNETVENTIL FÜR GRANULAT	ELECTROVALVULA MOTORIZADA PARA GRANULADO
YMA	ELETTROVALVOLA MOTORIZZATA	MOTORIZED SOLENOID VALVE	ELECTROVANNE MOTORISE	MOTORISIERTES MAGNETVENTIL	ELECTROVALVULA MOTORIZADA
WFI	MODULO WIFI	WIFI MODULE	MODULE WIFI	WIFI-MODUL	MODULO WIFI
YVB	ELETTROVALVOLA VAPORE BOLLER	STEAM BOILER SOLENOID VALVE	ELECTROVANNE VAPEUR SURCHAUFFEUR	DAMPFMAGNETVENTIL BOILER	ELECTROVALVULA VAPOR CALDERIN
YVT	ELETTROVALVOLA VAPORE VASCA	STEAM TANK SOLENOID VALVE	ELECTROVANNE VAPEUR CUVE	DAMPFMAGNETVENTIL TANK	ELECTROVALVULA VAPOR CUBA

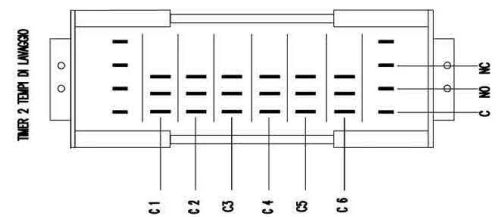
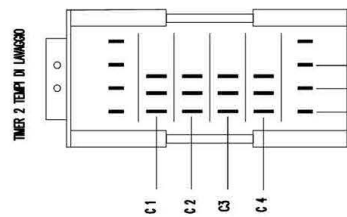
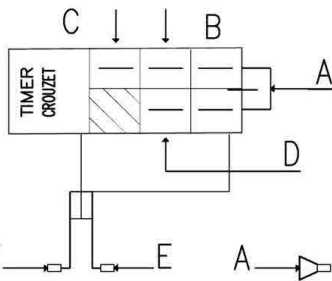
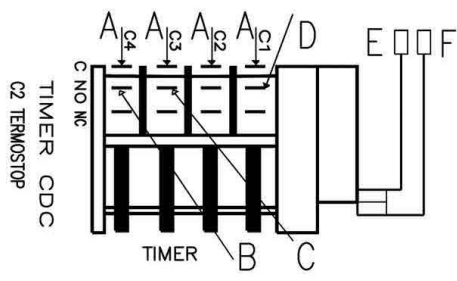

Spülmaschine US PPlus500 LPR + LPWR  
 Artikel-Nr.: 109640/109641

Schaltplan  
 Datum 17.10.2022

SIGLA	ITALIANO	INGLESE	FRANCESE	TEDESCO	SPAGNOLO
A1/A/B	TASTIERA	DISPLAY	AFFICHEUR	ANZEIGE	TECLADO
A2	SCHEDA DI POTENZA	MAIN BOARD	CARTE PUissance	HAUPTPLATINE	FICHA DE POTENCIA
B1	SONDA TERMOSTATO BOILER	STROBE BOILER THERMOSTAT	SONDE THERMOSTAT SURCHAUFFEUR	BOILER THERMOSTAT	SONDA TERMOSTATO CALDERIN
B2	SONDA TERMOSTATO VASCA	STROBE TANK THERMOSTAT	SONDE THERMOSTAT CUVE	TANK THERMOSTAT	SONDA TERMOSTATO CUBA
B3	SONDA CAMERA LAVAGGIO	WASH CHAMBER PROBE	SONDE CHAMBRE DE LAVAGE	SONDE WASHKABINE	SONDA SALA DE LAVADO
B4	SONDA ACQUA INGRESSO	INPUT WATER PROBE	SONDE D'EAU D'ENTREE	ENGAANGSWASSERSONDE	ENTRADA Sonda DE AGUA
C1-2-3	FILTRO ANTIDISTURBO	CONDENSER	CONDENSATEUR	KONDENSATOR	FILTRO ANTI-PERTURBACION
CP	CONDENSATORE POMPA	PUMP CONDENSER	CONDENSATEUR POMPE	PUMPENKONDENSATOR	CONDENSADOR BOMBA
D1-2-3-4	DIDO	DIDOS	DICDE	DICDOS	DIDO
E1	BLOCCO PORTA	DOOR LOCK	SERRAGE PORTE	TÜRSFERRÉ	BLOQUEO DE PUERTA
EL1	LED COLORE BLU	LED BLUE	LED COULEUR BLEU	LED BLAU	LED COLOR AZUL
EL2	LED COLORE ROSSO	LED RED	LED COULEUR ROUGE	LED ROT	LED COLOR ROJO
EL3	LED COLORE VERDE	LED GREEN	LED COULEUR VERT	LED GRÜN	LED COLOR VERDE
FM1	PASTIGLIA TERMICA POMPA 1	SAFETY THERMIC SENSOR PUMP 1	SECURITE THERMIQUE POMPE 1	SICHERHEITSSENSOR DER PUMPE 1	SEGURIDAD TERMICA BOMBA 1
FM2	PASTIGLIA TERMICA POMPA 2	SAFETY THERMIC SENSOR PUMP 2	SECURITE THERMIQUE POMPE 2	SICHERHEITSSENSOR DER PUMPE 2	SEGURIDAD TERMICA BOMBA 2
FR1	RELE TERMICO POMPA 1	THERMIC RELAY PUMP 1	RELAIS THERMIQUE POMPE 1	THERMORELAIS DER PUMPE 1	RELE TERMICO BOMBA 1
FR2	RELE TERMICO POMPA 2	THERMIC RELAY PUMP 2	RELAIS THERMIQUE POMPE 2	THERMORELAIS DER PUMPE 2	RELE TERMICO BOMBA 2
FR3	RELE TERMICO POMPA RISCACQUO	THERMIC RELAY RINSGUO PUMP	RELAIS THERMIQUE POMPE RINÇAGE	THERMORELAIS DER SPÜLUNGSPUMPE	RELE TERMICO BOMBA DE DESCARGUE
FR6	RELE TERMICO MOTORE CESTO	THERMIC RELAY RACK MOTOR	RELAIS THERMIQUE MOTEUR PANIER	THERMORELAIS DES KORB MOTORS	RELE TERMICO MOTOR CESTA
FR7	RELE TERMICO MOTORE CONDENSA	THERMIC RELAY CONDENSER	RELAIS THERMIQUE MOTEUR CONDENSE	THERMORELAIS DES KONDENSATORS	RELE TERMICO MOTORA GUA DE CONDENSACION
FU1-2-3-4	FUSIBILI 1-2-3-4	FUSE 1-2-3-4	FUSIBLES 1-2-3-4	SCHMELZSICHERUNGEN 1-2-3-4	FUSIBLE 1-2-3-4
G2	ALIMENTATORE	POWER SUPPLY	ALIMENTATION	STROMV. VERSORGUNG	ALIMENTACION
G3	CONVERTITORE	CONVERTER	CONVERTISSEUR ELECTRIQUE	WÄNDLER	CONVERTIDOR
HL1	SPA RETE	MAIN SWITCH LIGHT	VOYANT RESEAU ELECTRIQUE	NETZWERK-LEUCHTE	INDICADOR DE RED
HL10	SPA POMPA SCARICO	DRAIN PUMP LIGHT	VOYANT POMPE DE VIDANGE	KONTROLLEUCHTE LAUGENPUMPE	INDICADOR BOMBA DE DESAGUE
HL2	SPA CICLO	CYCLE LIGHT	VOYANT CYCLE	BETREIBSLEUCHTE	INDICADOR DE CICLO
HL3	SPA RIGENERAZIONE	REGENERATION CYCLE LIGHT	VOYANT REGENERATION	REGENERATIONSLEUCHTE	INDICADOR REGENERACION
HL4	SPA TEMPERATURA	TEMPERATURE LIGHT	VOYANT TEMPERATURE	TEMPERATURELEUCHTE	INDICADOR TEMPERATURA
HL5	SPA ALLARME	ALARM WARNING LIGHT	VOYANT ALARME	ALARMAWÄRDER	INDICADOR ALARMA
HL6	SPA VASCA	TANK LEVEL LIGHT	VOYANT NIVEAU CUVE	TANKWASSERNIVEAULAMPE	INDICADOR CUBA
HL7	SPA SALE	SALT LIGHT	VOYANT SEL	KONTROLLEUCHTE SALZ	INDICADOR SAL
HL8	SPA RISCALDAMENTO VASCA	TANK HEATING LIGHT	VOYANT CHAUFFAGE CUVE	KONTROLLEUCHTE TANKERHEIZUNG	INDICADOR CALIFACCION CUBA
HL9	SPA RISCALDAMENTO BOILER	BOILER HEATING LIGHT	VOYANT CHAUFFAGE SURCHAUFFEUR	KONTROLLEUCHTE BOILERERHEIZUNG	INDICADOR CALIFACCION CALDERIN
KA	RELE GENERALE	MAIN RELAY	RELAIS	HAUPTRELAIS	RELE GENERAL
KA1-2-3-4	RELE AUSILIARIO	AUXILIAR BLAY	RELAIS AUXILIAIRES	HILFSRELAIS	RELE AUXILIAR
KAM3	RELE POMPA AUMENTO PRESSIONE	RELAY BOOSTER PUMP	RELAIS SURPRESSEUR	NACHSPÜLPUMPE RELAIS	RELE BOMBA AUMENTO DE PRESION
K1	TERLUTTORE GENERALE	MAIN CONTACTOR	TERLUTTEUR GENERALE	HAUPTFERSCHALTER	TERLUTTOR GENERAL
KB KBIN	TERLUTTORE BOILER	BOILER CONTACTOR	TERLUTTEUR SURCHAUFFEUR	FERNSCHALTER DES BOILERS	CONTACTOR CALDERIN
KBS	TERLUTTORE SICUREZZA BOILER	BOILER SAFETY CONTACTOR	TERLUTTEUR SECURITE SURCHAUFFEUR	SICHERHEITS-FERNSCHALTER DES BOILERS	CONTACTOR DE SEGURIDAD CALDERIN
KM1	TERLUTTORE POMPA LAVAGGIO 1	PUMP CONTACTOR TANK 1	TERLUTTEUR POMPE CUVE 1	FERNSCHALTER DER WASH-PUMPE 1	CONTACTOR BOMBA LAVADO 1
KM2	TERLUTTORE POMPA LAVAGGIO 2	PUMP CONTACTOR TANK 2	TERLUTTEUR POMPE CUVE 2	FERNSCHALTER DER WASH-PUMPE 2	CONTACTOR BOMBA LAVADO 2
KM2	TERLUTTORE POMPA LAVAGGIO 3	PUMP CONTACTOR TANK 1	TERLUTTEUR POMPE CUVE 1	FERNSCHALTER DER WASH-PUMPE 1	CONTACTOR BOMBA LAVADO 1
KM2/A	TERLUTTORE POMPA LAVAGGIO 2	PUMP CONTACTOR TANK 2	TERLUTTEUR POMPE CUVE 2	FERNSCHALTER DER WASH-PUMPE 2	CONTACTOR BOMBA LAVADO 2
KM3	TERLUTTORE POMPA AUMENTO PRESSIONE	BOOSTER PUMP CONTACTOR	SURPRESSEUR TERLUTTEUR	FERNSCHALTER DER NACHSPÜLPUMPE	CONTACTOR BOMBA AUMENTO DE PRESION
KM4	TERLUTTORE POMPA POMPA SCARICO	DRAIN PUMP CONTACTOR	TERLUTTEUR POMPE DE VIDANGE	SCHÜTZ ENTLERUNGSPUMPE	CONTACTOR BOMBA DE DESCARGA
KM6	TERLUTTORE MOTORE CESTO	RACK MOTOR CONTACTOR	TERLUTTEUR MOTEUR PANIER	FERNSCHALTER DES KORB MOTORS	CONTACTOR DE MOTOR CESTO
KM7	TERLUTTORE MOTORE ASPIRATORE	STEAM CONDENSER CONTACTOR	TERLUTTEUR ASPRATEUR MOTEUR	FERNSCHALTER DES DAMPFKONDENSATORS	CONTACTOR DE MOTOR EXTRACTOR
KV KV/N	TERLUTTORE VASCA	TANK CONTACTOR	TERLUTTEUR CUVE	FERNSCHALTER DER TANK	CONTACTOR CUBA
KV/S	TERLUTTORE SICUREZZA VASCA	SAFETY TTANK THERMOSTAT	THERMOSTAT DE SECURITE CUVE	SICHERHEITSTHERMOSTAT DER TANK	TERMOSTATO DE SEGURIDAD TANK
L	REATTORE	REACTOR	REACTEUR	REAKTOR	BOMBA DE REACCION
M1	POMPA LAVAGGIO 1	PUMP TANK 1	POMPE CUVE 1	WASH-PUMPE 1	BOMBA DE LAVADO 1
M1/A	POMPA LAVAGGIO 3	PUMP TANK 3	POMPE CUVE 3	WASH-PUMPE 3	BOMBA DE LAVADO 3
M10	DOSATORE SANITIZZANTE ELETTRICO	ELECTRIC SANITIZING DISPENSER	DOSEUR ASSAINISSEMENT ELECTRIQUE	ELEKTRISCHES SANITISATIONSMITTELDOSEGERÄT	DOSIFICADOR DE SANIAMENTO ELECTRICO
M11	MOTORE VENTOLA CONDENSATORE	CONDENSER FAN MOTOR	MOTEUR VENTILATEUR CONDENSEUR	KONDENSATOR-GEBLÄSE MOTOR	MOTOR VENTILADOR CONDENSADOR
M2	POMPA LAVAGGIO 2	PUMP TANK 2	POMPE CUVE 2	WASH-PUMPE 2	BOMBA DE LAVADO 2
M2/A	POMPA LAVAGGIO 4	PUMP TANK 4	POMPE CUVE 4	WASH-PUMPE 4	BOMBA DE LAVADO 4
M3	POMPA AUMENTO PRESSIONE	BOOSTER PUMP	POMPE AUGMENTATION PRESSION	NACHSPÜLPUMPE	BOMBA AUMENTO DE PRESION
M4	POMPA SCARICO	DRAIN PUMP	POMPE DE VIDANGE	LAUGENPUMPE	BOMBA DE DESCARGUE
M5	DOSATORE DETERGIVO ELETTRICO	ELECTRIC DETERGENT PUMP	DOSEUR ELECTRIQUE DETERGENT	DOSEGERÄT	DOSIFICADOR DE JABON ELECTRICO
M6	MOTORE CESTO	RACK MOTOR	MOTEUR PANIER	KORB MOTOR	MOTOR CESTO
M7	MOTORE ASPIRATORE	STEAM CONDENSER	MOTEUR D'ASPIRATION	DAMPFKONDENSATOR	MOTOR A SPRADOR
M8	POMPA LIFT	PUMP LIFT	POMPE LIFT	LIFT PUMPE	BOMBA LIFT
M9	DOSATORE BRILLANTANTE ELETTRICO	ELECTRIC RINSE AID DISPENSER	DOSEUR DE RINÇAGE ELECTRIQUE	ELEKTRISCHES KLARSPUELMITTELDOSEGERÄT	DOSIFICADOR DE ACLARADO ELECTRICO
MZ	MOTORE TIMER	TIMER MOTOR	MOTEUR PROGRAMMA TEUR	TIMER MOTOR	MOTOR TIMER
MZV	MOTORE TIMER VELOCE	FAST TIMER MOTOR	MOTEUR PROGRAMMA TEUR A GRANDE VITESSE	SCHNELLTIMER MOTOR	MOTOR TIMER RAPIDO
Q1	INTERRUTTORE ON/OFF	MAIN SWITCH	INTERRUPTEUR GENERAL	HAUPTSCHALTER	INTERRUPTOR GENERAL
RB	RESISTENZA BOILER	BOILER HEATING ELEMENT	RESISTANCE SURCHAUFFEUR	BOILERHEIZUNG	RESISTENCIA CALDERIN
RV	RESISTENZA VASCA	TANK HEATING ELEMENT	RESISTANCE CUVE	TANKHEIZUNG	RESISTENCIA CUBA
S1	PULSANTE START CICLO	CYCLE SWITCH	BOUON DEMARREUR	START-TASTE	BOTON DE CICLO
S10	PULSANTE SET TIMER	TIME SETTINGS BUTTON	BOUON SET TIMER	SET TIMER BEDIENKNOFF	BOTÓN SET TIMER
S2	PULSANTE DEPURAZIONE	REGENERATION CYCLE SWITCH	BOUONON REGENERATION	REGENERATION TASTE	BOTON DE DEPURACION



Spülmaschine US PPlus500 LPR +LPWR  
 Artikel-Nr.: 109640/109641

Schaltplan  
 Datum 17.10.2022