



**T 5110RS / 117552**  
**T 7110RS / 117572**  
**T 10110RS / 117512**

**ENGLISH**

**Original operating manual**

**Table of contents**

**1. Safety ..... 69**  
1.1 Key to symbols ..... 69  
1.2 Important safety instructions ..... 70  
1.3 Use as intended ..... 75  
1.4 Use against the intended purpose ..... 75

**2. General information ..... 76**  
2.1 Liability and Warrantees ..... 76  
2.2 Copyright protection ..... 76  
2.3 Declaration of conformity ..... 76

**3. Transport, packaging and storage..... 77**  
3.1 Delivery check ..... 77  
3.2 Packaging..... 77  
3.3 Storage..... 77

**4. Technical data ..... 78**  
4.1 Properties of T series combi steamers ..... 78  
4.2 Technical specification ..... 79  
4.3 Overview of parts..... 85

**5. Installation and operation..... 86**  
5.1 Instructions for the installer ..... 86  
5.1.1 Installation instructions ..... 86  
5.1.2 Installation place ..... 87  
5.1.3 Preparing for Installation ..... 88  
5.1.4 Adjustment of the feet ..... 88  
5.1.5 Location ..... 89  
5.1.6 Water connection ..... 89  
5.1.7 Drain connection ..... 90  
5.1.8 Connection for the cleaning agent supply hose ..... 91  
5.1.9 Adjustment of door locking pin ..... 91  
5.1.10 Electrical connection ..... 92  
5.1.11 Start-up and acceptance ..... 93  
5.2 User instructions ..... 95  
5.2.1 Safety notes ..... 95  
5.2.2 Operating instructions ..... 96

5.3	Cooking process .....	97
5.3.1	Description of pictograms .....	97
5.3.2	HOME screen .....	99
5.3.3	How to interact with the touch-screen .....	99
5.3.4	Manual cooking mode.....	100
5.3.5	Customised cooking programs .....	105
5.3.6	Creating a cooking program .....	106
5.3.7	Saving a cooking program .....	107
5.3.8	Modifying a cooking program.....	109
5.3.9	Copying, moving, renaming, and deleting a cooking program .....	109
5.3.10	Selecting a program from the menu.....	110
5.3.11	The Recipe Tuner interfaces.....	112
5.3.12	Rack Control mode .....	113
5.3.13	Using the Easy Service function in Rack Control.....	118
5.3.14	Programmed start .....	119
5.3.15	Core probe and cooking in $\Delta T$ .....	120
5.3.16	Recommendations for cooking .....	121
5.4	FUNCTIONS menu .....	122
5.4.1	WASHING.....	122
5.4.2	COOLING .....	124
5.4.3	SERVICE .....	125
<b>6.</b>	<b>Cleaning and maintenance.....</b>	<b>127</b>
6.1	Regular cleaning by the user .....	128
6.2	Humidity drain .....	128
6.3	Door cleaning.....	129
6.4	Ventilation filter cleaning .....	129
6.5	Maintenance provided by the service technician.....	130
<b>7.</b>	<b>Description of alarms.....</b>	<b>130</b>
<b>8.</b>	<b>Waste disposal .....</b>	<b>132</b>

Bartscher GmbH  
Franz-Kleine-Str. 28  
33154 Salzkotten  
Germany

Tel.: +49 5258 971-0  
Fax: +49 5258 971-120  
**Service-Hotline:** +49 5258 971-197  
[www.bartscher.com](http://www.bartscher.com)



**Read this instruction manual before using and keep them available at all times!**

This instruction manual contains information about the installation, operation and maintenance of the device and should be consulted as an important source of information and reference guide.

Awareness of the safety instructions and instructions for use in this manual will ensure the safe and correct use of the device.

In addition to the information given here, you should comply with any local Health and safety Controls and generally applicable safety regulations.

The instruction manual forms part of the product and should be kept near the device and easily accessible for anyone carrying out the installation, servicing, maintenance or cleaning.

Please keep these instructions and give them to future owners of the device.

## 1. Safety

This device is designed in accordance with the presently applicable technological standards. However, the device can pose a danger if handled improperly and inappropriately.

All persons using the device must follow the recommendations and instructions in this instruction manual.

### 1.1 Key to symbols

In this manual, symbols are used to highlight important safety instructions and any advice relating to the device. The instructions should be followed very carefully to avoid any risk of accident, personal injury or material damage.



**WARNING!**

This symbol highlights hazards which could lead to injury.



**WARNING!**

This symbol highlights dangerous situations which could lead to injury or death.



## HOT SURFACE!

This symbol is a warning that the device surface is hot when in use. Ignoring this warning may result in burns!



## Hot liquid in the tank! Risk of burns!

When containers hold liquid or products that turn liquid during cooking, do not higher shelves to place the containers so that the operator can always look into the container inside.



## CAUTION!

This symbol highlights dangerous situations which could lead to light injuries, or damage, malfunction, and/or destruction of the device.



## NOTE!

This symbol highlights recommendations and information aimed for effective and trouble-free device operation.

## 1.2 Important safety instructions

- The device is not intended for use by individuals (including children) with physical or mental disabilities, insufficient experience, and/or insufficient knowledge unless such persons are under the care of a person responsible for their safety or have received instructions regarding appropriate use of the device.
- Take care of children to keep them playing with or starting the device.
- **Never** leave the device unattended when in use.
- Prevent access of children to the package materials like plastic bags and foamed polystyrene elements. **Suffocation hazard!**

- Only use the device indoors.
- The device is not adapted for use with an external timer or remote control.
- The device must be operated only in perfect and safe condition. In case of malfunction immediately disconnect the device from the power supply and contact the service company.
- Only a qualified technician and using original spare parts and accessories should carry out repairs and maintenance of the device. **Do not attempt to repair the device yourself.**
- Do not use any accessory or spare parts that have not been recommended by the manufacturer. These can be dangerous for the user or lead to damages of the device or personal injury, and further, the warranty expires.
- To prevent hazards and to ensure optimum efficiency, no modifications or alterations to the device that are not explicitly approved by the manufacturer may be undertaken.



**DANGER! Electric shock hazard!**

To avoid the hazard results please follow the safety instructions below.

- Never allow the power cable to come into contact with heat sources or sharp edges. The power cable should not hang over the side of the working surface. Ensure that no one can step on or trip over the cable.
- The power cable must not be folded, bent or tangled, and must always remain fully unrolled. Never place the device or other objects on the power cable.

- Do not cover the cable. Keep away the cable from operating range and do not dunk it into water.
- Inspect the power cable regularly for damage. Never use the device if the cable is damaged. If the power cable is damaged, have an authorised service center or qualified electrician replace it.
- Never open the housing of the device. If the electrical connections are damaged or electrical or mechanical design is changed, **there is a risk of electrical shock.**
- **Never** use abrasive agents and make sure no water gets into the device.
- Never handle the device with wet hands or while standing on the wet floor.
- Disconnect the device from the power supply:
  - when the device is not used,
  - in the case of interruptions during the operation of the device,
  - before cleaning the device.



## **HOT SURFACE! Danger of burns and injury!**

To avoid the hazard results please follow the safety instructions below.

- During operation, the surface of the device becomes very hot! Do not touch the hot surface of the device! Hold the device during operation only at the handles and control elements envisaged for this.
- Even after switching off the surface of the device and the cooking space as well as food in the containers remain hot for quite some time. In order to take out the food from the cooking space, always apply thermal gloves.

- In the course of opening the combi steamer door the hot steam can may escape, so be particularly careful.
- Let the device cool down sufficiently before cleaning it.



**Hot liquid in the tank! Risk of burns!**

To avoid the hazard results please follow the safety instructions below.

- During preparation of food or liquids in the containers pay attention to the possible spillage, either during cooking or during removing the container from the chamber.
- When the combi steamer is placed on another combi steamer or appropriate base **it is not recommended** to use the higher guides, preventing looking into the container.  
Due to safety reasons after positioning the device place the



sticker **“Hot liquid in the tank!”** included in the delivery on the device **1.6 m** above the floor.





## **WARNING! Fire or explosion hazard!**

To avoid the hazard results please follow the safety instructions below.

- Before using the device make sure that there are no objects in the oven chamber, like plastic bags, operation manual, or accessories. Never put any kitchen utensils, towels, paper, or other things into or onto the oven.
- Make sure that the steam outlet is not covered or clogged.
- **Never** operate the device in the vicinity of flammable, easily ignited (e.g. gasoline, spirit, alcohol, etc.). Due to the heat they evaporate and in case of contact with ignition sources it can come to explosionen, which lead to serious personal injury and property damage.
- Clean the cooking space regularly and keep it always clean: fats and baking residues which are not removed, can ignite.
- Should a fire occur, disconnect the device from the power supply initiate appropriate fire fighting measures.

**Attention: Do not pour water onto the device still being under voltage: danger of electric shock!**

Provide sufficient supply of fresh air.

### 1.3 Use as intended



#### **CAUTION!**

**This device has been designed and built for commercial use and can be operated in kitchens by the qualified personnel only!**

Every use of the device for a different purpose and/or in a way that diverges from the intended use is not allowed and is assumed as the use against the intended purpose.

Any claims against the manufacturer or their authorized representatives as a consequence of experiencing damage resulting from the use against the intended purpose are inadmissible.

The liability for damage occurred during the use of the device against its intended purpose is borne solely and exclusively by the user.

Safety operation of the device is guaranteed only when it is used for its intended purpose and according to the instructions included in this manual.

**The combi steamer is designed only for preparation of appropriate food.**

### 1.4 Use against the intended purpose

Any use other than those mentioned in point “**1.3 Use as intended**“ is assumed as the use against the intended purpose and is not allowed.

The use against the intended purpose may lead to severe injury or damage caused by hazardous voltage, fire or high temperature. It is allowed to use the device to perform only the work described in the instruction manual. Improper use may cause the device damage.

Any manipulation with the device, assembly or maintenance work may be performed exclusively by the authorized service staff.

## 2. General information

### 2.1 Liability and Warrantees

All the information and instructions in this manual take into account standard safety regulations, current levels of technical engineering as well as the expertise and experience we have developed over the years.

The instruction manual was translated with all due care and attention. However, we do not accept liability for any translation errors. The German version of this instruction manual is definitive.

If the delivery consists of a special model, the actual scope of delivery may differ from the descriptions and illustrations in this manual. This is also the case for special orders or when the device has been modified in line with new technology.



#### **CAUTION!**

**Read this manual carefully and thoroughly before any operation of the device, and especially before turning it on!**

Manufacturer **is not liable** for any damages or faults caused by:

- violation of advice concerning operation and cleaning;
- use other than designed;
- alterations made by user;
- use of inadequate spare parts.

We reserve the right to make technical changes for purposes of developing and improving the useful properties.

### 2.2 Copyright protection

The instruction manual including any texts, drawings, images or other illustrations is copyright. No part of this publication may be reproduced, transmitted or used in any form or by any means without permission in writing from the manufacturer. Any person who commits any unauthorized act in relation to this publication shall be liable to claims for damages. All rights reserved.



#### **NOTE!**

**The contents, texts, drawings, pictures and any other illustrations are copyright and subject to other protection rights. Any person unlawfully using this publication is liable to criminal prosecution.**

### 2.3 Declaration of conformity



The device complies with the current standards and directives of the EU. We certify this in the EC declaration of conformity. If required we will be glad to send you the according declaration of conformity.

## 3. Transport, packaging and storage

### 3.1 Delivery check

Please check the delivery upon completeness and transport damage immediately after receipt. In case of visible damage do not accept or accept the delivery with reservation only.

Note the extent of damage on the carrier's bill of delivery. Trigger off the complaint.

Hidden damages should be reclaimed immediately after notice, as claims for damages can only be asserted within the effective period for complaints.

### 3.2 Packaging

Please do not throw away the covering carton of your device as it might be useful for storage purposes, when moving or, in case of damages, when the device must be sent back to a repair center. The outer and inner packing material should be removed completely from the device before installation.



**If you liked to dispose the packing, consider the regulations applicable in your country. Supply re-usable packing materials to the recycling.**

Please inspect the device upon completeness. In case any part is missing please contact our customer service center immediately.

### 3.3 Storage

Keep the package closed until installation and under consideration of the outside indicated positioning- and storage markings.

Packages should be stored under consideration of the following:

- do not store outdoors,
- keep it dry and dust-free,
- do not expose it to aggressive media,
- do not expose it to direct sunlight,
- avoid mechanical shocks and vibration,
- in case of longer storage (> 3 months) make sure you check the state of the packaging and the parts regularly, if required refresh or renew.

## 4. Technical data

### 4.1 Properties of T series combi steamers

- **Functions:** Circulating air, steaming, combi steaming, delta-T cooking, steam generation via direct injection, reversing motor run (fan wheels), 3-phase cleaning system with drying program
- Control: touch, control knob
- Number of cooking programs: 99
- Number of cooking phases: 9
- Extraction connection
- Fan speed: 3 levels
- Cleaning system
- Internal lighting
- Core probe connection
- Water connection 3/4
- Double door glazing
- Removable rails

### Protective devices

The device is equipped with the following protective systems:

**Protective thermostat** in the chamber: when the temperature in the steamer chamber reaches 350°C the thermostat opens the supply circuit of the device heaters.



#### **WARNING!**

**That protection must be reactivated by the technical service personnel as its operation indicates that other elements must be inspected.**

The **door switch** interrupts the device operation after opening the door: either the heating system and the fan are turned off.

## 4.2 Technical specification

Description	Combi steamer 5110RS
Code-no.:	117552
Material:	Stainless steel
Model:	<ul style="list-style-type: none"><li>▪ Rails:<ul style="list-style-type: none"><li>- Number 5</li><li>- Format: 1/1 GN or 600 x 400 mm</li><li>- Type: crosswise</li><li>- Distance between the rail pairs: 74 mm</li></ul></li></ul>
Maximum load capacity:	8/10 kg per shelf
Temperature range:	50°C to 300°C
Temperature control:	stepless
Time setting:	0 to 599 minutes
Power supply:	6.3 kW / 400 V / 50 Hz
Equipment connection:	3 NAC
Dimensions:	W 875 x D 830 x H 660 mm
Weight:	90 kg
Includes:	1 grate 1/1 GN 1 baking tray 1/1 GN 1 PVC waste pipe 1 water supply tube 1 supply tube for cleaning agent

We reserve the right to make technical changes!

<b>Description</b>	<b>Combi steamer 7110RS</b>
Code-no.:	<b>117572</b>
Material:	Stainless steel
Model:	<ul style="list-style-type: none"><li>▪ Rails:<ul style="list-style-type: none"><li>- Number 7</li><li>- Format: 1/1 GN or 600 x 400 mm</li><li>- Type: crosswise</li><li>- Distance between the rail pairs: 74 mm</li></ul></li></ul>
Maximum load capacity:	8/10 kg per shelf
Temperature range:	50°C to 300°C
Temperature control:	stepless
Time setting:	0 to 599 minutes
Power supply:	9.6 kW / 400 V / 50 Hz
Equipment connection:	3 NAC
Dimensions:	W 875 x D 830 x H 850 mm
Weight:	105 kg
Includes:	1 grate 1/1 GN 1 baking tray 1/1 GN 1 PVC waste pipe 1 water supply tube 1 supply tube for cleaning agent

We reserve the right to make technical changes!

<b>Description</b>	<b>Combi steamer 10110RS</b>
Code-no.:	<b>117512</b>
Material:	Stainless steel
Model:	<ul style="list-style-type: none"> <li>▪ Rails:               <ul style="list-style-type: none"> <li>- Number 10</li> <li>- Format: 1/1 GN or 600 x 400 mm</li> <li>- Type: crosswise</li> <li>- Distance between the rail pairs: 75 mm</li> </ul> </li> </ul>
Maximum load capacity:	8/10 kg per shelf
Temperature range:	50°C to 300°C
Temperature control:	stepless
Time setting:	0 to 599 minutes
Power supply:	12.6 kW / 400 V / 50 Hz
Equipment connection:	3 NAC
Dimensions:	W 875 x D 830 x H 1 050 mm
Weight:	117.4 kg
Includes:	1 grate 1/1 GN 1 baking tray 1/1 GN 1 PVC waste pipe 1 water supply tube 1 supply tube for cleaning agent

We reserve the right to make technical changes!

### **Additional accessories (not included in the delivery!)**

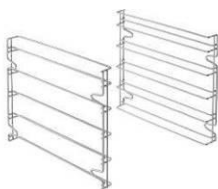

#### **Rails 5 x 600x400, pair**

- Material: CNS 18/10
- Number of rail pairs: 5
- Rail format: 600 x 400 mm
- Dimensions: W 360 x D 390 x H 60 mm
- Weight: 1.9 kg

**Code-no. 116001**





### Rails 7 x 600x400, pair

- Material: CNS 18/10
- Number of rail pairs: 7
- Rail format: 600 x 400 mm
- Dimensions: W 390 x D 360 x H 60 mm
- Weight: 2.2 kg

**Code-no. 116002**



### Rails 10 x 600x400, pair

- Material: CNS 18/10
- Number of rail pairs: 10
- Rail format: 600 x 400 mm
- Dimensions: W 725 x D 390 x H 60 mm
- Weight: 4.15 kg

**Code-no. 116003**



### Core probe set

- Set elements: 1 core probe  
1 handle
- Cable length: 1.8 m
- Temperature sensor material: Stainless steel
- Dimensions: W 180 x D 265 x H 25 mm
- Weight: 0.57 kg

**Code-no. 116009**

### Manual shower for combi steamer



- Material: Plastic, metal
- Cable length: 2 m
- Water connection: 1/2"
- Properties: 1/2" cut-off valve for rigid water connection
- Includes: 1 handle
- Dimensions: W 2160 x D 75 x H 30 mm
- Weight: 1 kg

**Code-no. 116005**



### Set for combi steamer humidifying

- Material: Plastic, metal
- Set elements: 1 plastic canister (5 l)  
1 pump  
1 connection pipe:  
canister pump (150 cm)  
1 connection pipe: Humidifying pump pipe (80 cm)  
Installation material
- Dimensions: W 325 x D 260 x H 140 mm
- Weight: 0.98 kg

**Code-no. 116011**

### Pressure reducer for combi steamer



- Material: Brass, chrome-plated
- Connection 3/4"
- Water pressure: 1 - 6 bar (factory set 3 bar)
- Maximum inlet pressure: 16 bar
- Maximum operating temperature: 65°C
- Dimensions: W 95 x D 75 x H 50 mm
- Weight: 0.4 kg

**Code-no. 533051**



### Cleaning agent for combi steamer RS-5L

- Designed for: combi steamers with the cleaning system, series E-RS and T-RS
- Capacity: 5 litres
- Dimensions: W 195 x D 150 x H 252 mm
- Weight: 5 kg

**Code-no. 116299**



### Support for combi steamer 10 x 1/1 GN

- Material: CNS 18/10
- Number of rail pairs: 10
- Rail format: GN 1/1
- Rail type: longitudinal
- Feet adjustable height 741 mm to 790 mm
- Dimensions: W 850 x D 700 x H 741 mm
- Weight: 25 kg

**Code-no. 115069**

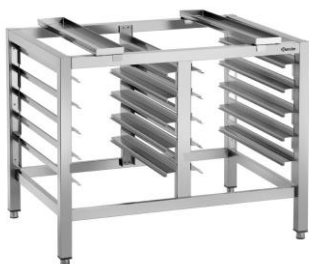

### Support ME 10E11640

- Material: CNS 18/10
- Number of rail pairs: 10
- Rail format: 1/1 GN, 600 x 400 mm
- Rail type: longitudinal
- Feet adjustable height 745 mm to 790 mm
- Dimensions: W 950 x D 700 x H 745 mm
- Weight: 24 kg

**Code-no. 115079**

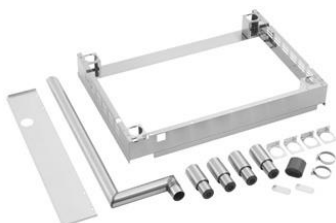

### Connection set for combi steamer "M, E + T"

- Material: Stainless steel
- Set elements: 1 frame  
1 pipe and supporting sheet for vapour extraction  
1 connection pipe  
4 feet  
fixing clamps bolts
- Possible combinations: 5 x 1/1 GN by 5 x 1/1 GN  
5 x 1/1 GN by 7 x 1/1 GN
- Dimensions: W 876 x D 622 x H 114 mm
- Weight: 9.2 kg

**Code-no. 116012**

### 4.3 Overview of parts

Fig. 1

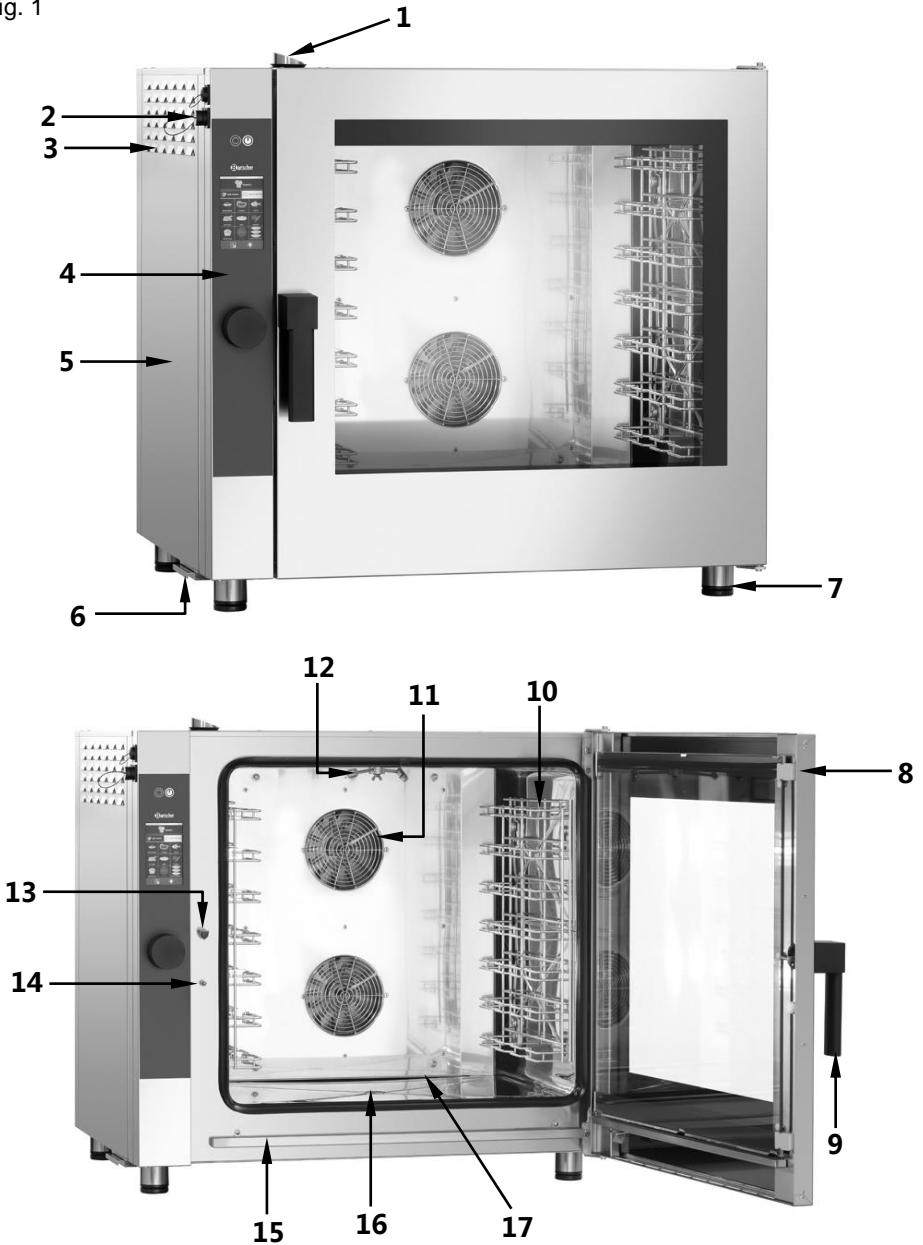

## Description of fig. 1 on page 85

- |   |                           |
|---|---------------------------|
| <b>1</b> Extraction connection              | <b>10</b> Rails           |
| <b>2</b> Core probe connection              | <b>11</b> Fan             |
| <b>3</b> Ventilation slots                  | <b>12</b> Washing nozzle  |
| <b>4</b> Control panel                      | <b>13</b> Door latch      |
| <b>5</b> Housing                            | <b>14</b> Contact switch  |
| <b>6</b> Ventilation filter operation panel | <b>15</b> Drain tray      |
| <b>7</b> Adjustable feet                    | <b>16</b> Steamer chamber |
| <b>8</b> Door                               | <b>17</b> Drain           |
| <b>9</b> Door handle                        |                           |

## 5. Installation and operation

### 5.1 Instructions for the installer



#### **CAUTION!**

**Any operation related to installation, assembly, operation and maintenance must be performed by the specialized personnel who has appropriate qualifications (manufacturer' or seller's authorisation). The required activities need to be performed while taking into account the installation regulations valid in a given country as well as the product safety legislation and health and safety regulations.**

#### 5.1.1 Installation instructions

- Before the installation and the use of the device, read carefully these operating instructions.
- Defective installation, mistakes during the operation, conservation and cleaning, as well as possible changes and modifications may cause improper operation, damages and injuries.
- The producer is not responsible for the injuries or damages resulting from not following the above regulations or tampering and using non-original spare parts.

- Immediately after receiving the device, make sure that it has not been damaged in transit, and that the packaging is not damaged. In the case of damage or missing components, immediately notify the shipper or vendor/manufacturer providing the **code-no. and serial numbers** (nameplate is on the back of the unit) and attaching photo evidence.
- Make sure that there are no obstacles on the path to the installation site limiting access through doors, corridors or other communication routes.
- **CAUTION:** In order to move the device to the installation site a pallet truck must be used to avoid tilting the device, which could cause damage or injury to objects and persons.

### 5.1.2 Installation place

- The device must be installed in closed and well ventilated rooms (not outdoor).
- Check the dimensions and the exact position of connections for electricity, water and extractor connections before installation of the combi steamer.
- We recommend to install the device under an extractor or to ensure the discharge outside the hot vapours and odours which emerge from the cooking space.
- The device must be installed on a flat surface in order to prevent it from slipping or tipping.
- The installation surface of the combi steamer must be suitable for the weight of the device at maximum load.
- Place the device unit on a firm, dry, water-resistant and heat-resistant surface. The installation surface must be well accessible and big enough to be able to operate freely with the device and to ensure good air circulation.

## 5.1.3 Preparing for Installation

- Remove the external packaging (wooden box and / or carton) and dispose them in accordance with the applicable provisions of the installation country.
- Before first use, remove the protective foil from the device. Peel the foil off slowly, so as not to leave any glue. If some glue remains, remove it using an appropriate solvent.
- Remove from the internal accessories, all information materials and plastic bags.



### CAUTION!

Never remove the nameplate and warning notes from the device.

## 5.1.4 Adjustment of the feet

- The adjustable feet are enclosed to the device and must be screwed under the device. The correct flatness of the device ensures a smooth operation. This flatness is obtained by adjusting the feet and verification by a spirit level. It is sufficient, to screw them in or screw out to change their settings. (Fig. 2).



### CAUTION!

Do not use the device without adjustable feet!

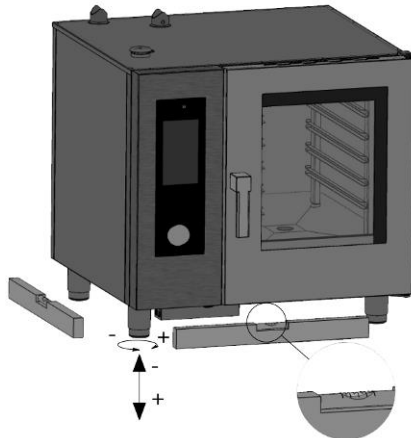

Fig. 2

- If the device is operated without adjustable feet, no air passage for cooling the electronic components and the external walls of the housing is ensured, this could cause overheating and result in damage of the components of this device.

### 5.1.5 Location

- **Never** place the device directly next to walls, furniture, or other objects made from flammable materials. Follow the valid fire protection regulations.
- Keep the minimum distance of **50 mm** between the device and walls or other devices and objects on the right side, at the back, and at the top.
- Keep the distance of **500 mm** on the left side between the device and the wall in order to assure convenient access to the connections.

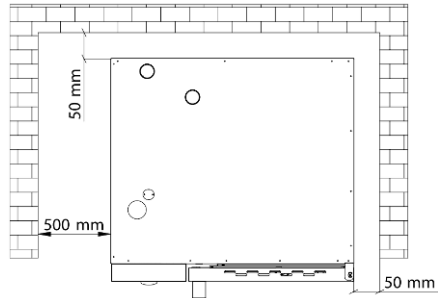

Fig. 3

- When it is not possible to leave the recommended distance, use appropriate protection means (e.g. heat-resistant foil that will ensure keeping the wall temperature within the safe range (up to 60°C).
- **The device is not designed for installation inside the furniture.**

### 5.1.6 Water connection

- Make sure that the potable water connection is located close to the device.
- In case of new installation drain sufficient water amount from the pipes in order to prevent the contaminants penetration into the device.
- The minimum water pressure should be higher than 1.5 bar to assure correct operation of the device.



#### **WARNING!**

The hydraulic water pressure should be **max. 6 bar (600 kPa)**.

In case of higher pressure install the appropriate pressure reducer upstream the device (page 84).



- Connect the water supply hose included in delivery to connection A (3/4"). That connection is located under the device, on the right side. Connect the other end of the hose to the **cold water installation** with a shut-off valve.
- Make sure that the valve is installed in easily accessible place.

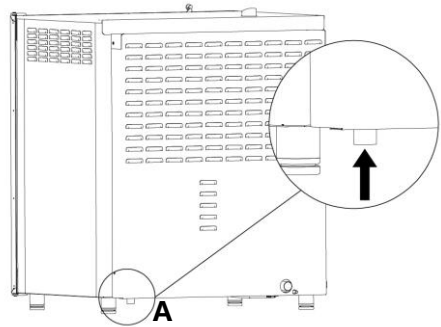

Fig. 4

- In order for the device to operate properly and to avoid limescale deposits in the chamber the drinking water of hardness up to 5° d.H (according to German scale) must be available.



## WARNING!

From 5° d.H. (according to German scale) it is strongly recommended to connect the appropriate water softener upstream the device.

### 5.1.7 Drain connection

- Install the included PVC drain pipe in the outlet opening (B) at the bottom, on the right side, at the back, to assure the liquid drain from the oven chamber.
- The drain pipe must be connected with appropriate hose (Ø 32 mm) and must lead to the sewage system.

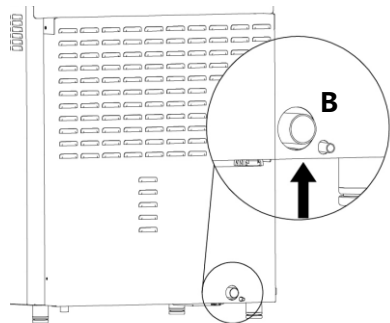

Fig. 5

### 5.1.8 Connection for the cleaning agent supply hose

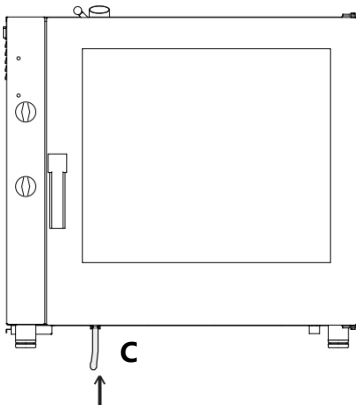

Fig. 6

Connection for the cleaning agent supply hose is located in the left lower part of the device. Fix the included supply hose to the connection.

The hose supplying the cleaning agent (**C**) should be immersed as deep as possible in the container with appropriate cleaning agent (fig. 6).

### 5.1.9 Adjustment of door locking pin

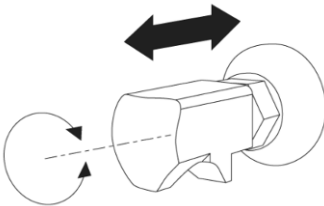

Fig. 7

When the device is positioned in appropriate place it is required to check closing and fixing of door seals in the chamber.

It is possible to adjust the depth of the closing pin in order to assure that the chamber is properly closed during cooking.

It is possible to adjust the door pressure on the seal. Screw the pin in to increase the pressure or screw it out to decrease the pressure (**Fig. 7**).

After adjustment retighten the bolt making sure that the lock anchor is positioned downwards.

## 5.1.10 Electrical connection



### **DANGER! Danger from electric current!**

**Improper installation of the device may result in injuries!**

**Prior to installation, compare specification of the local power network with the technical specifications of the device (see nameplate).**

**Connect the device only in case of conformity!**

- Before connecting the device to an electricity source, ensure that the voltage and frequency values given on the panel correspond to those of the electrical network. **The maximum permissible voltage difference is  $\pm 10\%$ .**
- Check if there is an SL connection fulfilling legal requirements. Use an appropriately cut cable when connecting the device to electricity.
- A multipolar breaker must be installed between the device and the electricity supply. The distance between contacts should be at least 3 mm, and it should be located in an easily-accessible place.
- Connect the device to the electricity supply in compliance with all international, domestic and local regulations.

### **Potential difference connection**

- Installation for connection of device of different potentials using the clip indicated as . The clip is located at the rear of the device.
- The clip is used to connect the potential difference wire (yellow-green) of a diameter from 4 to 10 mm<sup>2</sup>.
- The device should be connected to the potential difference circuit of the efficiency according to the recommendations included in the current legal regulations.

### 5.1.11 Start-up and acceptance

Before **the first start-up** the electric devices must be thoroughly inspected in order to confirm the consistency of the device and its installation with the valid regulations, technical data, and recommendations for safety.

The following conditions **must** be fulfilled:

- The temperature around the installation must be above + 4 °C.
- The cooking compartment must be empty.
- All packing elements must be completely removed, together with the protective film on the internal walls.
- Ventilation ducts cannot be blocked in any way.
- Any elements of the device disassembled during installation must be reassembled.
- The main electric switch must be turned on, and the water stopcock installed by the device must be open.

**The commissioning** of the device is realized upon the basis of the test cycle allowing for checking the correctness of operation and revealing any damages or problems.

- Turn the device on with use of on/off switch. (Ref. 1, Fig. 8).
- Set the cooking/baking time:

**time: 10 minutes    temperature: 150°C    humidity 5%.**

Perform thorough inspection according to the following procedure:

- The device lighting is turned on by pressing the appropriate key (Ref. 4 Fig. 8), and turns off automatically after 45 seconds unless it is turned off earlier by pressing the same key again.
- The device is turned off after opening the door and is turned on again after closing it.
- The fans motors automatically change their rotation direction every 3 minutes.
- The fans motors in the oven chamber always operate in the same direction.
- Check water outlet towards the fan from the pipe supplying moisture in the oven chamber.
- At the end of the cooking/baking cycle the acoustic signal is emitted.

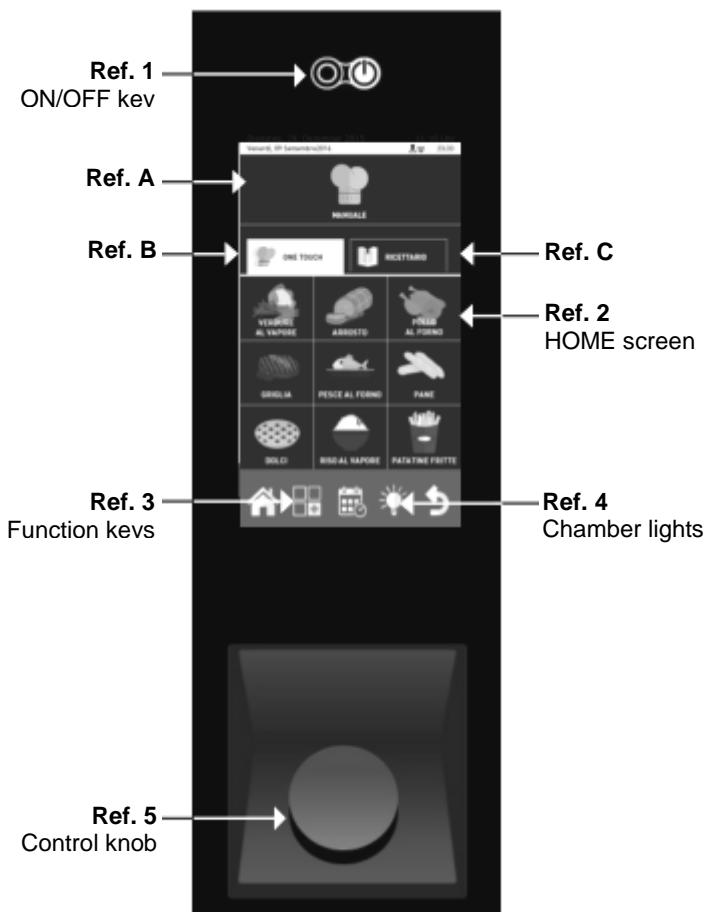

Fig. 8

## 5.2 User instructions



### CAUTION!

Read the following instructions carefully, because it provides notes concerning safety and use of the combi steamer.

Keep the instruction manual carefully for later use.

Any incorrect installation, operation, maintenance and cleaning as well as possible changes and modifications may cause malfunctions, damages or injuries.

### 5.2.1 Safety notes

- **Never** place the device near heat sources such as grill or fryer.
- **Never** allow easily flammable materials lying or stand in the vicinity of the device.  
**Fire hazard!**
- The temperatures of the food containers or other objects during and after cooking can be very high; be highly attentive in handling in order to avoid burns. Grasp them only with suitable protective gloves. **Danger of burns!**
- Be very cautious while opening the door. **Burn hazard** due to escaping hot steam.
- Do not place any flammable objects and any food based on alcohol in the combi steamer: they cause spontaneous combustion and fires, which can lead to explosive phenomena.
- Avoid salting the food in the cooking space of the combi steamer. If it cannot be avoided, ensure timely cleaning, otherwise it can lead to damage at the cooking space.



**The external parts of the combi steamer may not exceed the temperature of 60 °C. In order to avoid burns, the areas or parts which are marked with the adjacent symbol may not be touched.**

- Damages or breakage of components made of glass, from which the door is made up should be remedied without delay (contact the customer service).
- In the course of non-using of the combi steamer (e.g. 12 hours) leave the combi steamer door open.
- In case of prolonged non-use (for example for several days), close the water supply and disconnect the device from the power supply.
- Should the combi steamer be installed on table of stainless steel or other combi steamer, it is **not recommendable**, to use the higher insertions than those, at which the user can look into the container.

- For safety reasons, after installation of the device, the label  **”Hot liquid in container! Danger of burns!”**, which is located in the package must be attached to the combi steamer at a height of **1,6 m** from the floor.

## 5.2.2 Operating instructions



### **Hot liquid in the tank! Risk of burns!**

**During preparation of food or liquids in the containers pay attention to the possible spillage, either during cooking or during removing the container from the chamber.**

**It is not recommended to use the higher guides, preventing looking into the container.**

- During cooking or baking it is required to put the dripping tray for oil and juices on the chamber bottom.
- For perfect and uniform cooking it is recommended to use GN trays or containers of appropriate height to assure good and sufficient air circulation. There must be distance of minimum 2 cm between the upper tray and food.
- Do not overfill GN trays and containers, place food uniformly to obtain satisfactory results.
- Pay attention to correct use of the internal temperature sensor. Introduce it in the thickest place of food from above until reaching the centre by the sensor tip.
- Before use clean the device and accessories according to section **6 ”Cleaning and maintenance“**.
- Before start-up check the installation correctness, stability, levelling of the device, as well as connection to power supply and cold water.
- After connecting the device to the power supply it is in standby mode.
- The control panel is equipped with the knob (Ref. 5, Fig. 8). Rotate the knob to set the required parameters and press it to confirm the set values.
- To compensate the heat loss during door opening while putting the food products inside it recommend to preheat the device (**section 5.3.4 ”Manual baking/setting of automatic preheating“, p. 100**).

## 5.3 Cooking process

### 5.3.1 Description of pictograms

#### Start screen

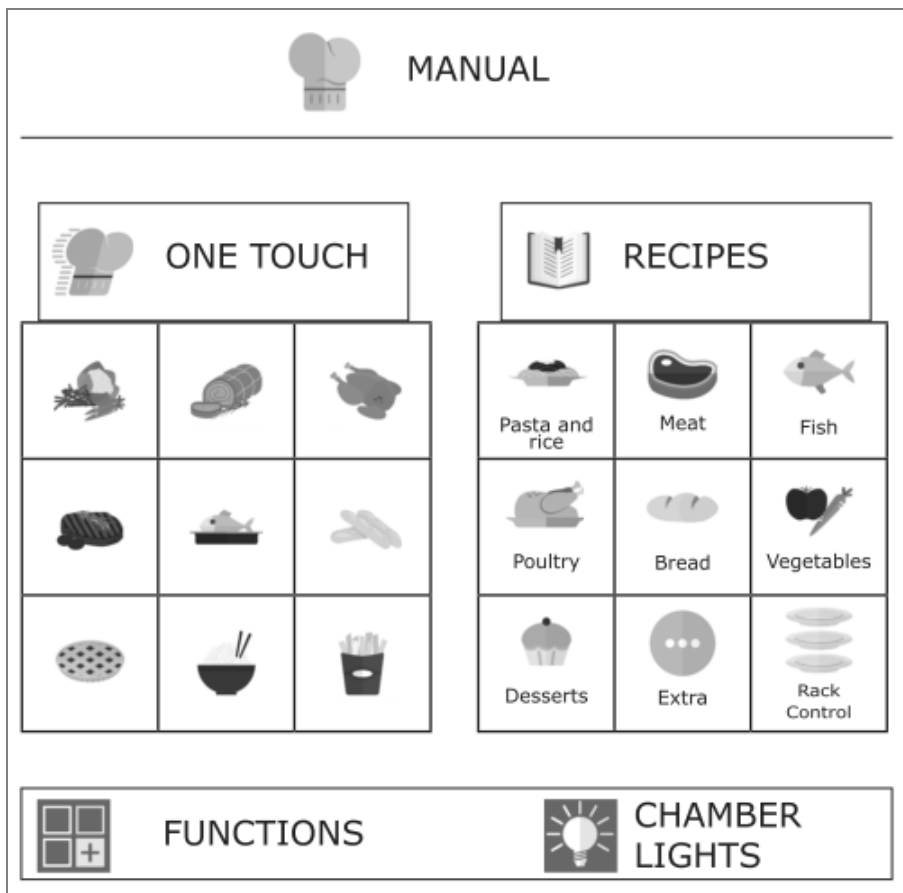

Fig. 9



## Manual cooking screen



Cooking mode: convection



Cooking mode: mixed



Cooking mode: steamed



Mode: maintenance



Automatic cooling.  
Present only from phase 2.



Mode: message



Mode: smoking



Time / timer



Core probe mode



Delta-T mode



Humidity discharge valve:  
closed



Humidity discharge valve:  
open



Relative humidity percentage



Unlock key: allows a program to  
be changed



Indicator of program changed by  
the user, or new program



During cooking, it allows the  
program SET to be checked



Manual humidifier key



Programmed start key



Home key: brings one back to the  
start screen

### 5.3.2 HOME screen

Turn the oven on by pressing the ON/OFF key (Ref. 1, Fig. 8), the initial "HOME" screen will appear on the display (Ref. 2, Fig. 8).



Fig. 10

It is possible to select whether to perform "Manual Cooking" (Ref. A), or use one of the favourite programs, set by the user in the "ONE TOUCH" program (Ref. B) or in the "Recipe book" (Ref. C).

By pressing key D access is given to the "Functions" menu where it is possible to set washing, import and export the cooking programs and change the oven system settings. (Some of these functions are password-protected and reserved exclusively for specialised technicians).

The "ONE TOUCH" groups (Ref. B) allow you to directly access your favourite recipes. Starting is realized by touching one of the symbols, cutting times to a minimum. These groups include cooking programs which the user has chosen to configure by customising the menu and the relevant icon.

The "Recipe book" (Ref. C) groups cooking programs, divided by product type, as for example: meat, vegetables, desserts, etc.

### 5.3.3 How to interact with the touch-screen

All of the operations can be selected by clicking on the desired item or pictogram.

To modify a cooking parameter, e.g. the temperature, click on the relative field and turn the knob (Ref. 5, Fig. 8).

To confirm the modification, click on the parameter again or press the knob (Ref. 5, Fig. 8).

## 5.3.4 Manual cooking mode

From the “Home” page, by pressing on “Manual” access is given to the cooking parameters setting screen.

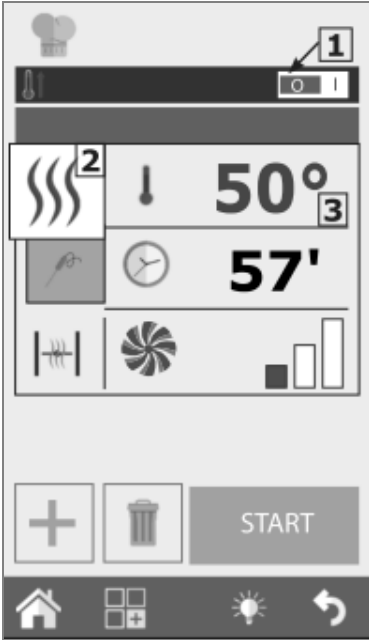

Fig. 11

In “Manual” mode, the oven can be set for individual cooking with one or more phases and/or a cooking program can be set and saved in the recipe books.

### Setting the automatic pre-heating

The "Preheating" function heats the oven to the desired temperature before the dishes to be cooked are introduced.

If the oven temperature is higher than the one indicated for pre-heating the oven, the oven will automatically cool down to the correct temperature.

“Pre-heating” is set automatically, but this function can be modified after the “Start” key has been pressed, by clicking on the temperature displayed.

By pressing key 1 on the left or right, this function can be enabled or disabled.

Automatic pre-heating must be realized with empty oven.

### Setting the cooking mode

Key 2 (Fig. 11) is set as default in the “**Convection**” cooking mode (hot air). By pressing this key, the cooking mode can be changed to **Mixed** or **Steam**. Alternatively, set a **maintenance cycle (HOLD)**, **message cycle** or **smoking mode**.

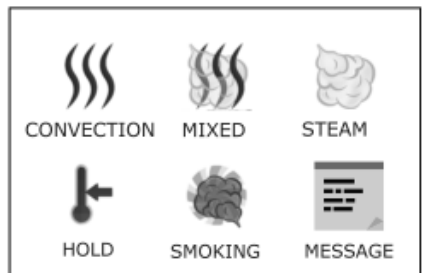

Fig. 12

## Cooking modes: convection, mixed, and steam

### Setting the cooking temperature

By pressing key **3** (Fig. 11) you can set the cooking chamber temperature. The temperature that can be set varies depending on the selected cooking method.

### Setting the timer / probe / Delta-T

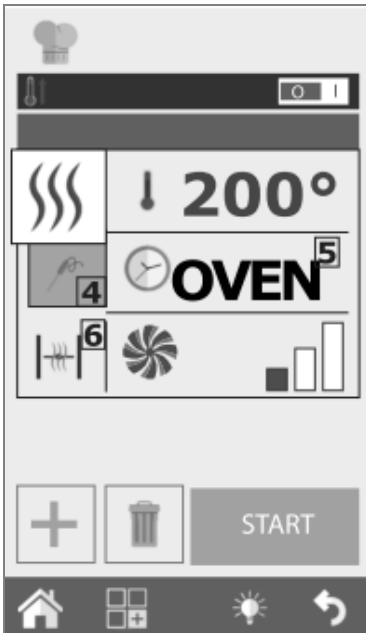

Fig. 13

Having selected the "Cooking Mode", you can cook in "timed" mode or using the "core probe".

By pressing key **5** (Fig. 13) you can set the timer (countdown).

The time is indicated in the minutes format (1h30' = 90 minutes).

On expiry of the time, the oven emits a sound and cooking stops.

If the time has not been set, cooking will take place in "infinity" mode (**INF**); the oven will continue to cook until the operator intervenes manually to stop cooking.

When cooking with the "core probe" it is possible to choose between probe (**4a**) and  $\Delta T$  (**4 b**).





Switching between those modes allows the product to be cooked more accurately.

Additional information on  $\Delta T$  cooking is given in section 5.3.15 "Core probe and  $\Delta T$ ".

### Setting the humidity discharge valve

Only in **Convection** mode it is possible to manually open (**6b**) or close (**6a**) the humidity discharge valve. When it is opened, the humidity present in the cooking chamber is evacuated, thus allowing the cooking chamber, and therefore the product, to dry.

Press key **6** (Fig. 13) to open or close the valve.

-  **4a** Core probe mode
-  **4b**  $\Delta T$  mode
-  **6a** Discharge valve closed
-  **6b** Discharge valve opened

## Setting the relative vapour percentage

In "Mixed" mode is it possible to set the percentage of humidity that the oven will maintain during cooking.

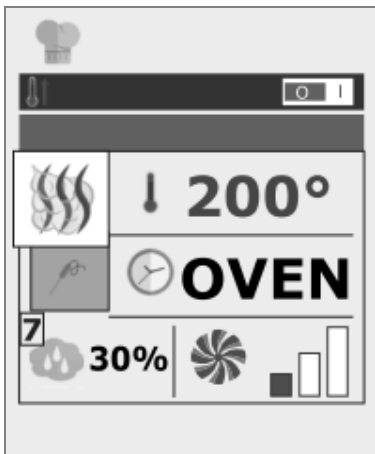

Fig. 14

To set the desired level of humidity, press key **7** (Fig. 14) and set the value.

## Setting fan rotation speed

The fan rotation speed parameter can be modified in the "Convection" and "Mixed" modes.

Instead, in the "Steam" mode, this setting is automatic.

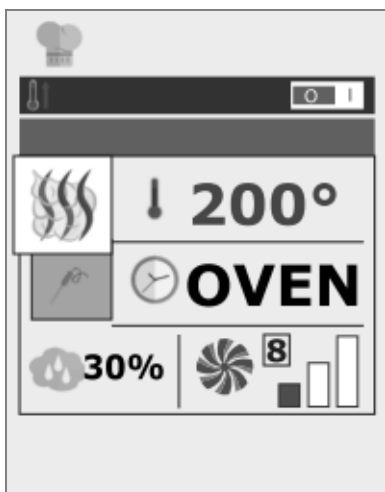

Fig. 15

Fan motors are designed for uniform heat distribution in the oven chamber in order to obtain the uniform cooking intensity and browning of products on various trays.

To set the rotation speed, press key **8** (Fig. 15) and select the desired level.

## HOLD (temperature maintaining) mode

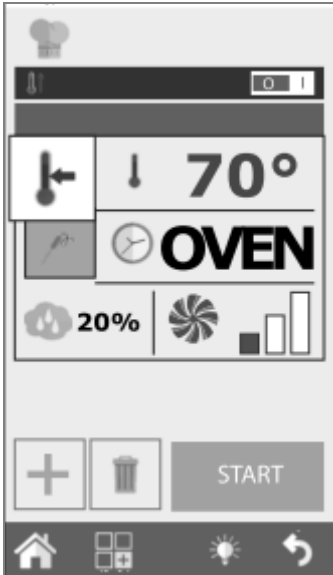

Fig. 16

The hold mode has the purpose of maintaining the products at a hygienically safe temperature (> 65 °C) without product core cooking undergoing changes.

It is usually used at the end of night time cooking to maintain the products cooked until the operator returns.

The HOLD mode by default has humidity set at 20% and the fan at speed 1. For effective maintenance, it is recommended not to modify fan speed. In case of roasted products, the hold humidity setting is recommended between 20% and 35%, in the case of brazing or stewing, humidity is recommended between 90% and 100%.

To modify the hold phase, press the cooking mode key (2, Fig. 11) and select HOLD (Fig. 16).

## Smoking mode

The "Smoker" accessory is required to perform smoking in the oven. This must be inserted into the oven on one of the trays before the smoking phase begins.

If the cooking program includes the cooking phase after the smoking phase, the "Smoker" accessory must be removed from the oven. Refer to the accessory manual for further information regarding the connection and use of the smoker.

Once cooking has been started by pressing **START** key (Fig. 17) the oven will ask for the smoker to be introduced before the smoking phase begins. At the end of the smoking phase the oven will request the removal of the smoker. Both processes must be confirmed by the operator. Only after confirmation the oven switches to the next phase.

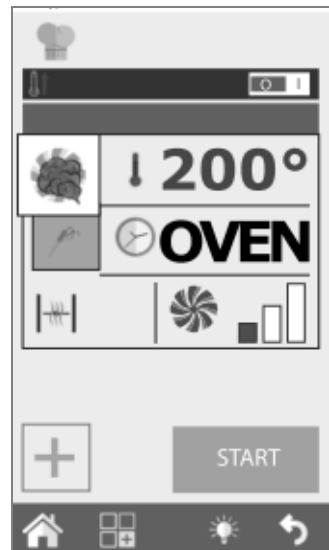

Fig. 17

In **Smoking** mode it is possible to set temperature, time, ventilation, and humidity drain valve. However, it is recommended to keep the valve closed so the smoke does not escape from the chamber.

Smoking can be performed both hot and cold, depending on the type of product and the desired result.

In the first case set temperature between 10 °C and 30 °C. The minimum temperature in the oven chamber will be similar to room temperature. The chamber can be cooled further by inserting ice.

The maximum temperature that can be set in this mode is 200 °C.

## Message mode

“Message” mode allows you to manage the cooking phases through messages which act as notes for the user.

It can be used for all cooking programs and allows the user to describe the entire cooking cycle, including manual phases requiring manual intervention.

Select “Message” mode from the cooking modes in a new phase.

From the menu that appears, enter your message on the screen (e.g. score the rind) and set the time required.

If you select INF time, the cooking cycle will not continue until the requested action is performed and confirmed.

If, however, you select a different time, the message phase will last for the required time and then, move on to the next phase without requesting confirmation.



Fig. 18

When selecting "Message" mode, you can enter a message from a list of existing messages or write a new one.

The message is managed like a cooking phase.

## Starting and stopping cooking

After setting the cooking parameters as desired, press the START key (9, Fig. 19), to start cooking.



Fig. 19

The oven will start in pre-heat mode if this has been previously selected. Otherwise it goes directly to the cooking mode.

By pressing "Advanced customisation" key (Fig. 20) you can manually select the specific starting phase for cooking or move from one phase to another of the cycle by selecting the desired phase and pressing the START key.

Cooking will last until the expiry of the time set or on reaching the core temperature in the core probe cooking mode.

In case of infinite time cooking must be stopped manually. To do this, press STOP key (10, Fig. 19).

### 5.3.5 Customised cooking programs

It is possible and easy to create customised cooking programs that can have up to 9 different phases plus preheating.

Every cooking phase is represented by a cooking mode (convection, mixed, steam, etc.) with specific time, humidity, ventilation parameters, etc.

**Example:** For a roast dish a program can be created that contains the following phases:

1. Browning
2. Roasting
3. Hold.

The essential condition for creating a successive phase is that the previous phase has a defined time. If phase 1 has the time set on infinity, it will not be possible to create phase 2 because the first phase has no end.

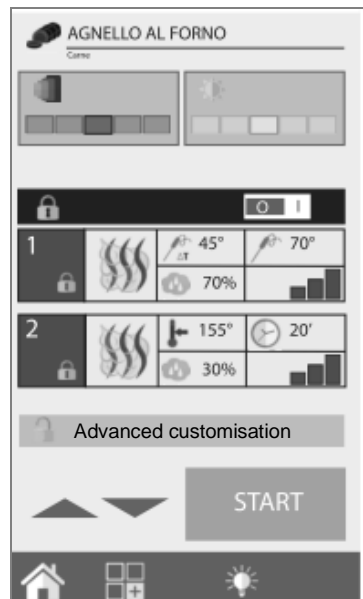

Fig. 20



The hold phase is an exception, which can be set on "INFINITY" and then have one or more cooking phases. Those phases must be however started manually, e.g. in the night time cooking of roast dishes, you may prefer to brown the dish when the operator returns to the kitchen, therefore after the hold phase.

To go from one cooking phase to another, press and hold the number of the phase you want to move to, or use the arrows to select the desired phase number and press START key.

There is a possibility of starting the program from the selected cooking phase (different from the first set): After having selected the program, press the "**Advanced customisation**" key and use the arrow to go to the desired phase. By pressing START key the program is started from selected phase. If pre-heating is included in this program, it will not be performed. The program can be modified using the Cooking Tuner interface before pressing the "**Advanced customisation**" key.

### 5.3.6 Creating a cooking program

A cooking program is made up of several phases, which the oven performs in ascending order (phase 1, phase 2, phase 3...) moving from one to another automatically.



Fig. 21

After setting the parameters for the initial phase (phase 1), press "+" key (11, Fig. 21) to create the next phase.

Set the required parameters for phase 2.

Continue with steps 1 and 2 to create additional phases.

You can also create and enter new phases between previously created phases.

The new phase will be placed under the one selected when you press key 11.

At the end of programming, press START (Fig. 21) to start cooking.

To delete a phase, press "**Eliminate Phase**" key (12, Fig. 21).

### Setting a cooling phase between two phases

The temperature inside the oven chamber may have to be cooled between one phase and another. For example, when roasting the chamber needs to be cooled between the browning phase (at high temperature) and the cooking phase (at low temperature).

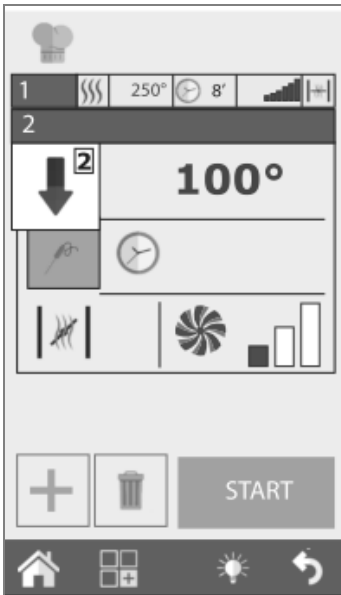

Fig. 22

This operation can be performed automatically by the oven by setting an automatic cooling phase.

The automatic cooling phase can only be set from phase 2 onwards.

After having set a high temperature phase, create a new phase and select automatic cooling from the cooking modes range (Ref. 2, Fig.8).

Once this mode has been selected, the oven will propose its default temperature, ventilation and humidity drain valve values. Set required cooling temperature (min. 100 °C, Fig. 22).

In order to make cooling as fast as possible, do not modify the ventilation and humidity drain valve values unless necessary.

### 5.3.7 Saving a cooking program

Created cooking program can be saved, for use at a later date, in a "Product type" group in the classic recipe book (meat, fish, chicken, etc.).

After having created a cooking program, press the functions key (13, Fig. 23), to access the programs function screen.

Select "Program Save" function (key 14, Fig. 23) and in the next screen press "Save" (15, Fig. 23), then select which group to save the program in. Then press "Next" key (16, Fig. 23).

Enter the program name and press "Enter" (key 17, Fig. 23) to save it.

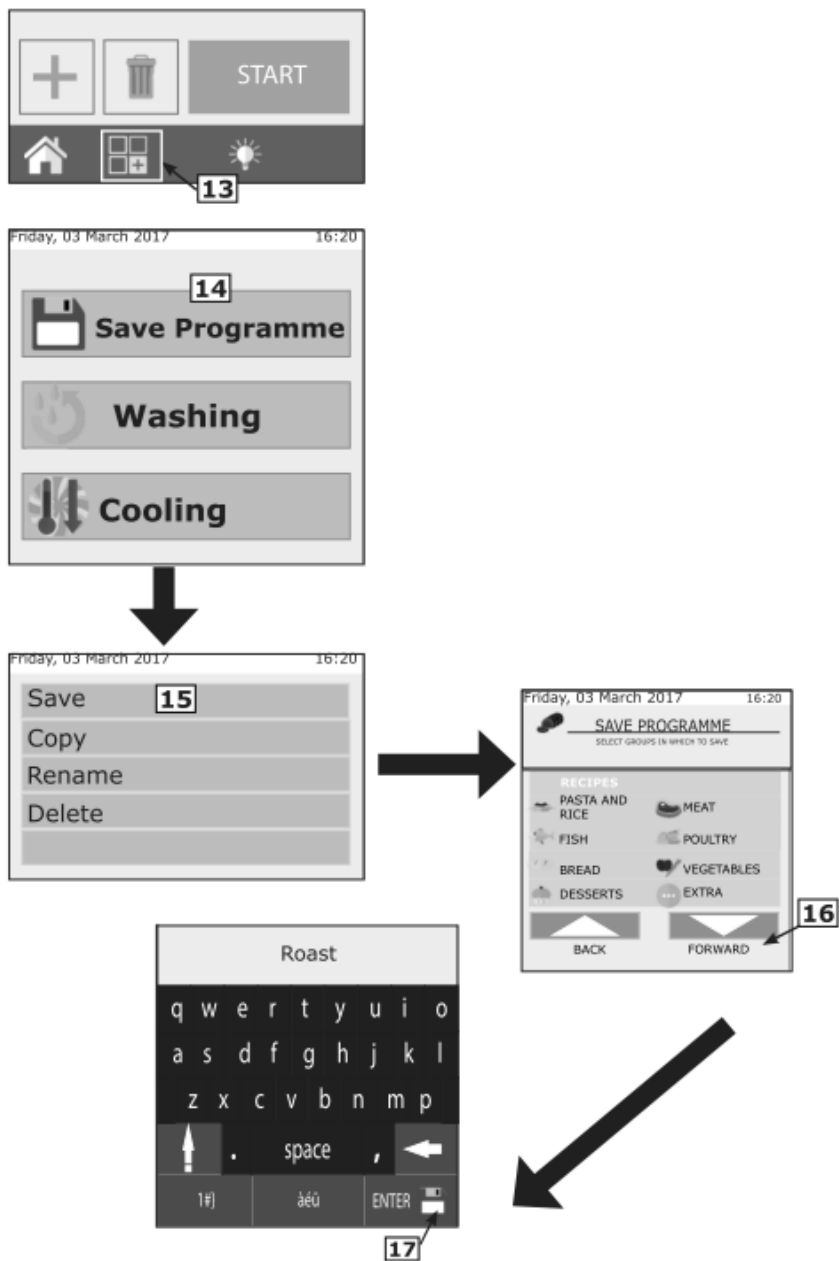

Fig. 23

### 5.3.8 Modifying a cooking program

On delivery the oven will already contain some cooking programs. Both the pre-loaded cooking programs and the new ones created can be customised.

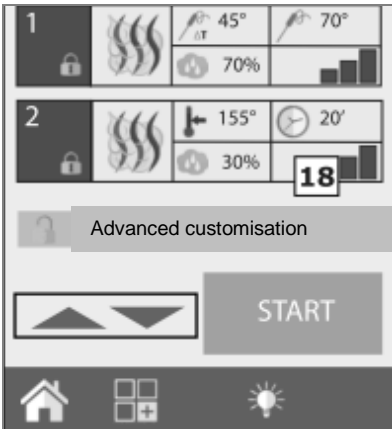

Fig. 24

To modify a program, first select the desired program from one of the recipe books. Once open, a summary of the phases set can be seen. That mode is write-protected and it is not possible to modify the cooking parameters. If one or more cooking parameters are to be changed or automatic pre-heating is to be activated/deactivated, press "Advanced customisation" (key **18**, Fig. 24) to unlock the program and make the desired modifications.



Fig. 25

Turn the knob (**19**, Fig. 25) to display the cooking phase to be changed.

After making the change you can start cooking directly. In this case, the changes will only apply to this cooking cycle and will not be saved.

You can also create a copy of the program with a different name which includes the changes made.

### 5.3.9 Copying, moving, renaming, and deleting a cooking program

Each available cooking program may be copied, moved, renamed, or deleted totally or partly.

#### Copying a cooking program

If a new program is to be created by starting from a program already present (because the old and new program share some cooking aspects), it may be copied. Select the group in which to save it and then type the name and press Enter to confirm.

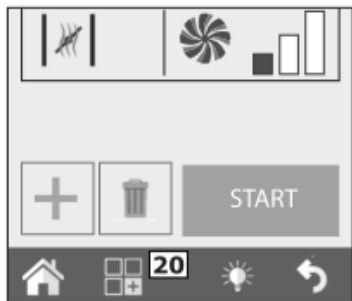

Fig. 26

Select the base cooking program, open it and make changes by pressing "Advanced customisation" (key **18**, Fig. 24).

Make required changes and press "Functions" (**20**, Fig. 26), select "Save" and then "Copy".

Select the group in which to save it and then type the name and press Enter to confirm.

### Moving a cooking program

If you want to move a program from one group to another, open the program and press "Functions" key (**20**, Fig. 26). Select "Save" and then "Move". Select the new group or new groups in which to move it and confirm with "Next" key (**16**, Fig. 23) .

### Renaming a cooking program

Open the program and press "Functions" (**20**, Fig. 26), select "Save" and then "Rename". Type in the new name and press "Enter".

### Deleting a cooking program

Open the program and press "Functions" (**20**, Fig. 26), select "Save" and then "Delete". Confirm by pressing **YES** in the pop-up window.

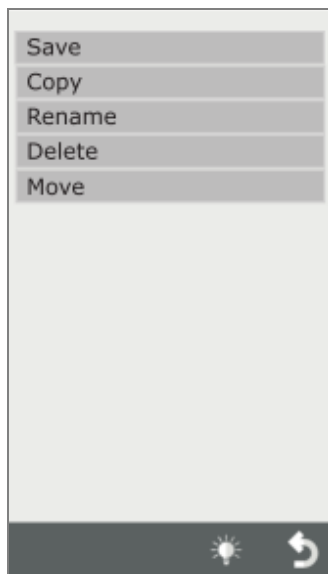

Fig. 27

## 5.3.10 Selecting a program from the menu

The oven is supplied with a series of cooking programs pre-loaded in the memory. They are divided by the product type (meat, fish, vegetables, etc.).

You can view them from the main menu under "recipe book"; the icon on "ONE TOUCH" screen allows the user to display the recipe icons directly which have been saved under favourites.

## ONE TOUCH

When the oven is switched on, the user's favourite recipes which have been set and loaded, are displayed.

By selecting the icon for a specific recipe, the oven will immediately start the cooking cycle, without requiring any other input, minimising the usage time.

To change the programs in "ONE TOUCH" mode, press and hold the icon

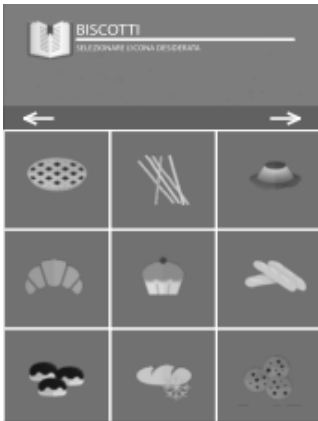

Fig. 29

## The "Recipe book" list

After pressing the "Recipe book" key (C1, Fig. 28) the cooking programs will be displayed, divided by product category, e.g. meat, fish, vegetables.

By selecting the desired product category, the list of all cooking programs will open relative to that category.

Select the desired program from the list.

To display your favourite cooking programs again, press "ONE TOUCH" key (C2, Fig. 30).



Fig. 28

of the recipe you want to replace. Select the recipe to put in the main menu from the list. Then select the icon to associate with the previously selected recipe from the list of available icons.

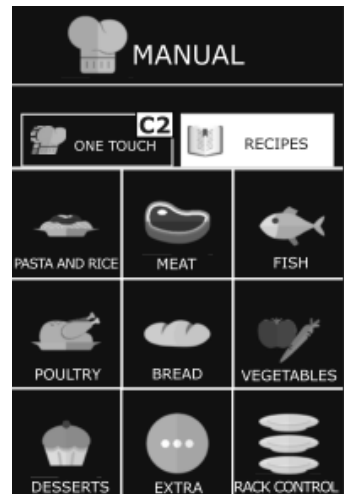

Fig. 30

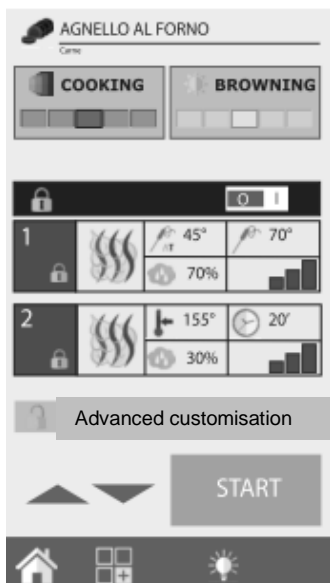

Fig. 31

### 5.3.11 The Recipe Tuner interfaces

Once a cooking program has been opened, it can be modified simply by using the **Recipe Tuner** interfaces.

Depending on the type of cooking selected, the cooking, browning, degree of rising, etc. of a product can be easily modified.

The **Recipe Tuner** function is available for pre-set programs and newly created ones. The **Recipe Tuner** system recognises the phase to be modified in order to meet cooking requirements.

#### Function of the interfaces

**Cooking:** allows modification of the cooking of a product. It is assumed that the cooking process is realized at 60 °C in the core on the average. The following settings may be used (starting from the left): “rare”, “medium-rare”, “medium”, “medium-well done”, and “well done”.

**Browning:** Product browning can be modified on 5 different levels from the lightest (on the left), to the most intense (on the right).

**Humidity:** When braising, it refers to the residual humidity on the product at the end of cooking.

**Rising:** It is possible to add the degree of rising (20 minute steps) and then perform an automatic "Rising" and "Cooking" program.

Cooking method	Interface	
Steaming	Roasting	
Grilling	Roasting	Browning
Roasting	Roasting	Browning
Frying	Roasting	Browning
Braising	Humidity	
Au gratin	Browning	
Bakery products	Rising	Browning
Low temperature	Roasting	
Smoking		
Eggs	Roasting	

### 5.3.12 Rack Control mode

The Rack Control function allows for separate control of up to 10 different levels during cooking. This function manages a unique “Cooking Mode” setting, temperature, humidity, etc. However, each level may have a core cooking time or temperature independent from the others.

Once the Rack Control icon (21, fig. 32) has been pressed, you access the list of pre-set programs, such as: Breakfast, Lunch, Multibaker, Mixed steam. Each of these programs will contain a series of corresponding dishes.

Example: The Lunch program will contain the dishes for the lunch service, such as grilled steak, breaded cutlet, stir-fried vegetables and lasagne.

It is also possible to create and add other programs and sub-programs (dishes).

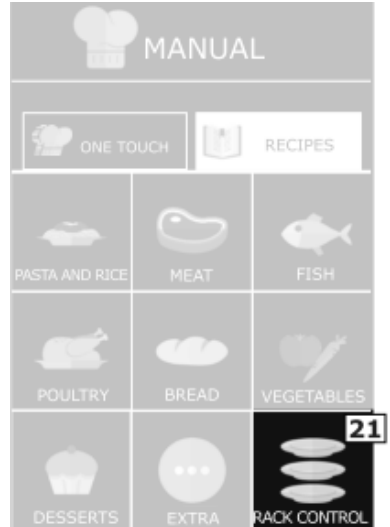

Fig. 32

### Using the Rack Control function

#### Selecting a Rack Control program

By selecting one of the programs from the list, for example: “Lunch”, will open a screen with the general program settings on the left: Pre-heat, Cooking Mode, Temperature, Fan, Butterfly valve (humidity or SteamTuner if the Mixed or Steam cooking mode is set).

5 empty levels will be seen in the right part.

#### Starting a Rack Control program

All Rack Control programs by default work with infinite time.

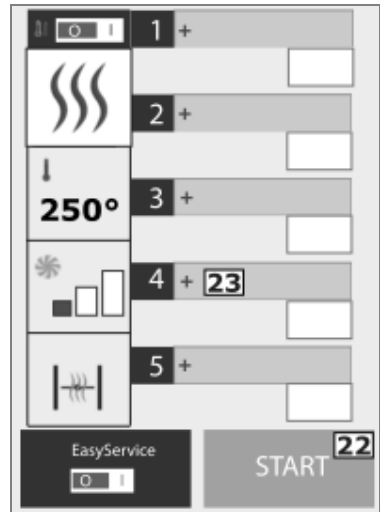

Fig. 33

Regardless of whether the program includes pre-heating or not, the first thing to do is start the program by pressing START (22, Fig. 33) .



## Adding dishes to the cooking program levels

After starting the program and at the end of pre-heating (if present), click on "+" symbol (key 23, Fig. 33) of each of the right hand boxes to add the name of the dish to enter in the selected level.

The digital display will show the list of sub-programs (dishes) already set. Select one by pressing it. It will be automatically added to the previously selected box.

Before selecting a dish, it must be placed inside the oven for cooking. Continue by adding the rest of the servings that are to be cooked. It is possible to add and manage up to a maximum 5 levels at a time.

The time remaining until the end of cooking will be displayed next to the level name. When probe cooking has been selected, the real core temperature is displayed.

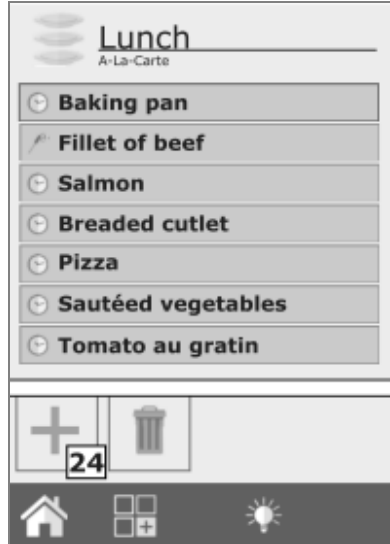

Fig. 34

## Creating of new names for dishes for the levels

New dish names can be added both to the programs created by the user and to those pre-set.

Enter the list of dishes, click on an empty box and press "+" (24, Fig. 34).

Enter the name of the dish into the screen along with the cooking time or the core temperature. Then press "Save" (25, Fig. 35) .

Press "+" (24, Fig. 34) to continue and add successive dish names.

### Deleting a dish from the list

To remove a dish from the list press and hold its name for a few seconds.

This operation is only possible if the cooking of this dish is NOT active.

### Direct or scheduled use

Rack Control can be used in direct mode and in programmed mode.

**Direct** is described in the previous chapter "Adding dishes to the cooking program levels".

Dishes are added after pressing START (and at the end of pre-heating, if present).



Fig. 35

In the **programmed** mode the dishes are added when the oven is in STOP mode, i.e. when it is not cooking. In such state the selected levels are not activated. They may be activated only after pressing START (and waiting until the end of pre-heating, if present), one by one, by clicking on the time box on the right.

### Modifying the time or temperature of the core probe

It is possible to change the cooking time or core probe setting by prolonged pressing their keys.

To modify, enter the list of dishes, select the name of the dish to be modified by prolonged pressing. Enter the new time (or probe temperature). The dish name may also be modified in this way.

To change the cooking time for a given dish during its cooking press on the remaining time box and enter new time or core probe temperature.

## The end of cooking a dish

When the pre-set cooking time of a dish has elapsed (or when the core temperature has been reached) the oven will emit an audible signal and the message **"END"** (26, Fig. 36) will appear in the time box. Carefully open the device door and remove the dish.

Opening and closing the door will automatically reset the level.

## Quick entering of a dish

During the cooking and work phase you may need to cook a product that is not on the list.

It is possible to quickly enter a dish in the Rack Control list without having to record it with a specific name.

Press the empty level and select sub-program called **"Tray"** (27, Fig. 37).

This represents a sub-program for which a different time can be set every time.

There is a possibility of entering multiple dishes simultaneously to the Rack Control list by using sub-program **"Tray"**.

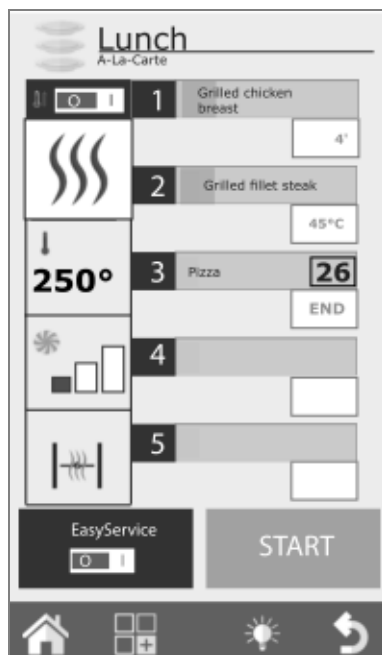

Fig. 36

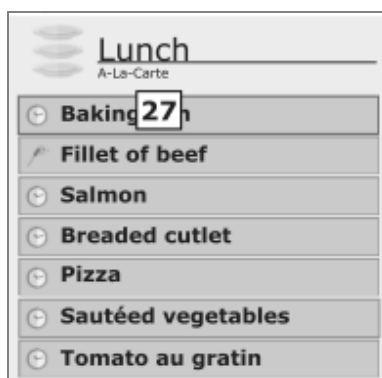

Fig. 37

### Modifying a Rack Control program

To change the Rack Control program after opening it press key **28** (Fig. 38) in the left column of displayed settings.

It is possible to modify at any moment the cooking mode, temperature, fan (excluding steam mode), and drain valve.

The entered change may be saved or the program may be copied, renamed, or deleted. In such case press the Functions key (**29**, Fig. 37) and proceed as explained in section 5.3.9 **“Copying, moving, renaming, and deleting a cooking program”**.

### Creating new Rack Control program

In addition to already existing Rack Control programs the customised programs can be created.

Enter the list of Rack Control programs; from the Home screen, click on the Rack Control icon. The first program shown at the top is **“Manual” (30, Fig. 39)**. It allows for creating new program and also to work in Rack Control mode without memorising the program. In the second case on exiting the program the cooking settings set will be lost.

To create a new program, enter the Rack Control menu, Manual section, and enter the desired cooking sets into the left column. Press the functions key (**29**, Fig. 38) and continue, memorising the program as described in section 5.3.7 **“Saving a cooking program”**.

Only after the program has been saved enter the list of dishes.

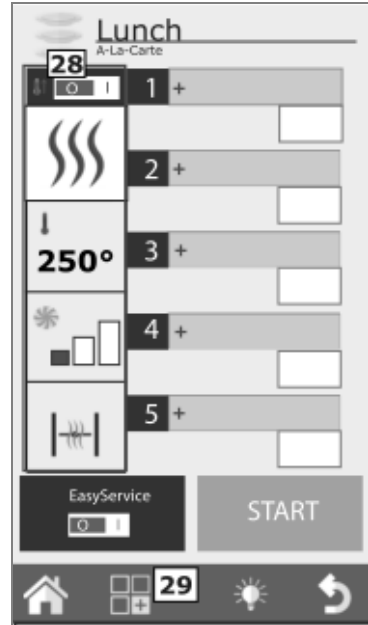

Fig. 38



Fig. 39

## Using the Rack Control in "Manual" mode

If you do not want to save the program, Rack Control may be used in manual mode. In this mode, specific dishes cannot be saved and the generic name "Tray" will be displayed for all levels.

### 5.3.13 Using the Easy Service function in Rack Control

Rack Control is designed to cook the dishes separately on the individual levels. The dishes may be introduced at the same time or different times, and as the times expire, the oven informs which level it has reached the end of cooking.

By activating the Easy Service function it is possible to have all of the dishes ready at the same time. That mode informs when it is necessary to insert the dishes at the various levels so that they are ready at the same time.

In this mode only levels with the time parameter setting can be selected (not with the core probe parameter).

### Activation of Easy Service

The Easy Service function must be activated before pressing the START key. It is only available when the oven is in STOP mode. To activate Easy Service, move the Easy Service switch (31, Fig. 40) to position "I". This action allows access to the list of dishes for Rack Control program.

Now select the dishes to be served at the same time (maximum 10) and press START key.

After pre-heating (if present) has ended the oven signals to put the dishes with the longer cooking time in the oven. The signal is an audible warning and the word "IN" (Fig. 41) in the right box. After opening and closing the door the acoustic signal is reset and the countdown begins.

On the other levels the residual time to placing dishes in the oven is displayed in green. The device signals in the same way when other dishes should be put inside the oven. The acoustic signal is emitted 15 seconds before the time elapses.

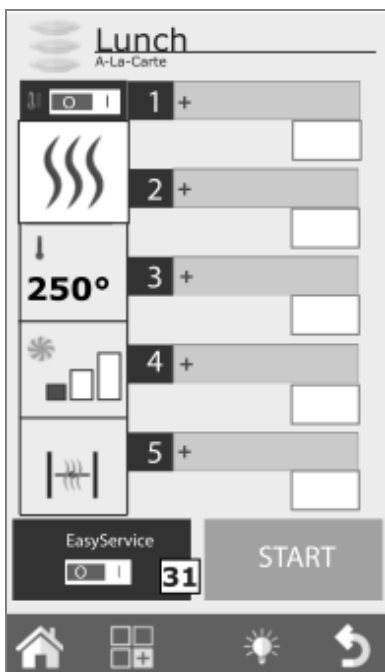

Fig. 40

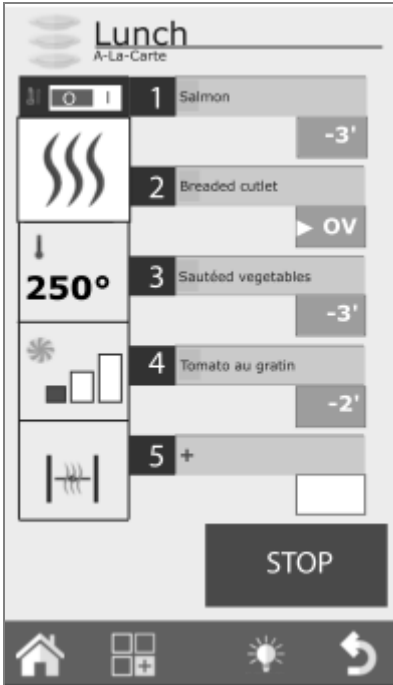

Fig. 41

### 5.3.14 Programmed start

A cooking cycle can be programmed to start by pressing key **32** (Fig. 42).

Select year, month, day, hour, and minutes on the screen and save the setting.

Once the setting has been saved, the oven cannot be switched off and additional cooking programs cannot be started.

It is recommended to wait until the timer reaches "0" and the word "IN" is displayed before placing dishes in the oven. In this way all of the dishes will be cooked exactly at the same time.

### Using Rack Control with Easy Service

When using Easy Service, other dishes may be added in Rack Control mode, which will be controlled independently from those selected for Easy Service. Both functions may be used at the same time only when Easy Service will be activated first and then other dishes will be added in Rack Control mode. Easy Service cannot be activated when Rack Control is already activated.



Fig. 42

## 5.3.15 Core probe and cooking in $\Delta T$

### Positioning the probe

Core probe detects the temperature in a point located in proximity of the probe.

The probe should be inserted in such way that the point is located in the product centre, in its bigger (thickest) part.

### Cooking processes in $\Delta T$ (Delta-T) mode

The  $\Delta T$  function is used mainly for slow, low temperature cooking.

In  $\Delta T$  mode, instead of setting the temperature in the chamber, the temperature that the oven must maintain constant between the product core temperature and the chamber must be set.

As the core temperature rises, the temperature in the chamber will increase at the same time.

While using  $\Delta T$  function it is necessary to use the core probe.

Temperature recommended for  $\Delta T$  cooking is in range from 15°C to max. 30°C.

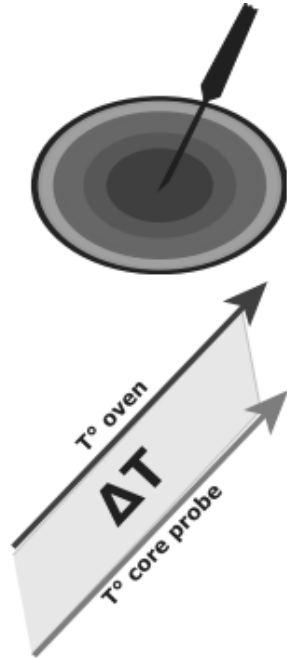

Fig. 43

### Core temperature

Food product	Baking process	Core temperature T°
Red meat	rare	50 °C
	medium	60 °C
	well done	70°C
Veal, pork, white meat	well done	70°C
Poultry	well done	80°C - 90°C
Boiled and braised meat	well done	80°C - 90°C
Fish	well done	67 °C - 72 °C

### **5.3.16 Recommendations for cooking**

#### **Roasting**

For more effective cooking, it is recommended to place the roasted foods on the steel rod grill in order to achieve more uniform cooking between the upper and lower part without having to turn the product during cooking. If you want to collect the juices, place a tray below the grill in the rails.

#### **Grilling**

To obtain the optimal effect during grilling in the oven chamber is necessary to use the grill (preferably aluminium).

The oven is generally set in convection mode, with valve open and temperature between 230 °C and 270 °C according to the type of product and browning that is to be obtained, and ventilation between 4 and 6.

#### **Frying**

All breaded and pre-fried frozen foods can be fried in the device. In case of breaded products, spray a thin layer of oil in such way that it is absorbed by the bread. Frozen pre-fried products can be fried without adding oil.

Use non-stick aluminium trays or special frying baskets. Set the oven to convection with the valve open, at temperature of 250°C and ventilation between 4 and 6.

#### **Recommendations for cooking uniformity**

The uniform cooking process may vary depending on type of prepared products. In such case it is recommended to lower temperature and change (increase or decrease) the fan rotation speed.

Using correct trays increases the general cooking uniformity of the oven. Always select the tray with the minimum depth possible for the product to be cooked. Aluminium trays offer more uniform cooking than steel trays.

#### **Cooking in a vacuum bag**

Product can be cooked directly inside a vacuum bag. This type of cooking allows for particularly soft and flavoured meat to be obtained and at the same time decreases spoilage of the product.

Pack the products into appropriate bags for vacuum cooking. Set the device to "Mixed cycle" at 100% humidity and ventilation between 3 and 4. The cooking chamber temperature must be maximum 3 °C-5 °C higher than the temperature which the core must reach. E.g. for an average fillet (60°C in the core) set the device temperature at 63 °C.



## Pasteurisation in a container

In that process the product is considered pasteurised when the core temperature reaches a value between 83 °C and 85 °C.

Depending on the type of product, dimensions of the container and amount of product it contains, the time of reaching the core temperature may vary. We recommend to use the core probe on a sample container (perforating the lid to allow the probe to enter) in order to detect the temperature of the entire production batch.

At the end of cooking the product must be quickly cooled down to +3°C to end the pasteurisation process.

## 5.4 FUNCTIONS menu

FUNCTIONS menu, accessible from the "HOME" screen, allows for access to the main routine maintenance functions and oven settings.

### 5.4.1 WASHING

In the FUNCTIONS menu select "WASHING" function (Fig. 44).

3 types of washing are available: **HARD**, **STANDARD**, and **SOFT** or **RINSE ONLY** mode (Fig. 45).

Selection of one of those types of washing depends on the amount of food residues and deposits of fat in the oven cooking chamber.

**HARD** is used for in-depth washing for very stubborn dirt, **SOFT** for a light wash.

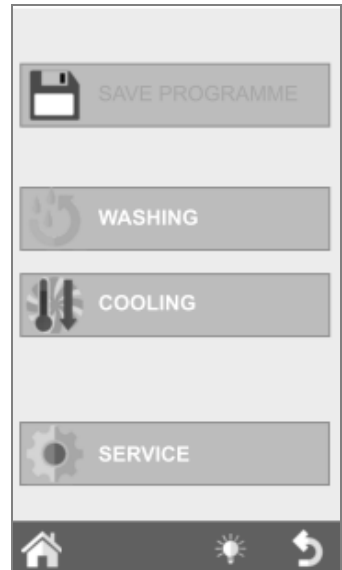

Fig. 44

Washing time and consumption of the washing agent depend on the washing type:

Washing type	Washing time	Detergent consumption
SOFT	48 min.	200 ml
NORMAL	53 min.	300 ml
HARD	58 min.	500 ml



Fig. 45

## USE OF A DIFFERENT DETERGENT MAY INVALIDATE THE WARRANTY!

### Washing interruption

The washing cycle can be interrupted by pressing and holding the knob, and entering the **password 222**.

If the detergent has already been loaded, the rinse phase will start, followed by the drying phase. Otherwise, the cycle will stop immediately.

The "RINSE ONLY" mode takes **approx. 8 minutes**.

After making these selections and pressing "OK", you are requested to check the product levels in the containers.

**IMPORTANT:** For correct washing and quality maintenance of the oven chamber, it is mandatory to use **only** the recommended

### Cleaning agent for combi steamer RS-5L

Art. no. 116299



Fig. 46

## 5.4.2 COOLING

This function allows the temperature inside the oven chamber to be lowered quickly, to pass from cooking at a high temperature to more delicate cooking, which requires lower temperatures (e.g. switching from roasting to steaming vegetables).

To start this function, press the START key and the fan will begin working. Open the oven door to force escape of hot air and entry of cooler air. This allows the desired temperature to be reached in a short time and to proceed with more delicate cooking.

Due to the safety reasons the cooling must be activated with closed door. The door must be opened only after starting the program.

The device is factory-set for this function for cooling the oven chamber to 50 °C. It is also possible for the user to set different required temperature, minimum 30 °C. After reaching that temperature the device interrupts cooling and emits the acoustic signal.

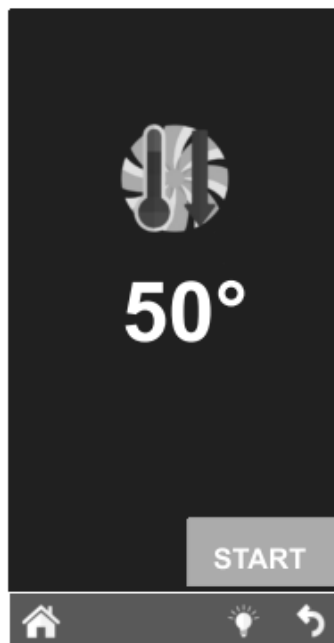

Fig. 47

Once the cooling cycle has started, you can speed the process up manually by inputting water into the chamber. This function is started manually by pressing "Manual humidifier" key (Fig. 48) for as long as needed.



Fig. 48



### **CAUTION! Risk of burns!**

**When opening the device hot air and steam may escape. Open the device door carefully. Use the protective gloves during the operation**

### 5.4.3 SERVICE

There are 4 functions available in this menu: **Configuration, View LOG, Advanced Services, and Import/Export**, allowing for to adjustment and displaying of range of functions and starting the oven maintenance procedures.



Fig. 49

#### 1. Configuration

The following configuration of parameters may be realized in this menu (Fig. 48):

- **Date and time**

This function allows for setting date and time parameters and updating them for the current use of the device.

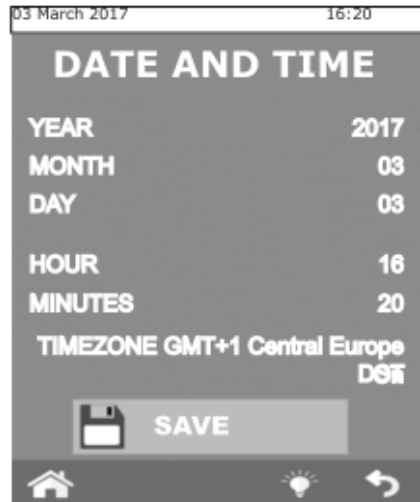

Fig. 50

## ▪ System info

This function allows you to view the software version installed in the oven and the serial number of the device.

## ▪ Language

This function allows for selecting language in which the commands and messages are displayed on the digital display.

## ▪ Interior lighting

This function allows for setting the brightness of the digital display. Select the function, set brightness, and press "Save".

## ▪ Acoustic signal volume

This function allows you to adjust the acoustic signal volume.



Fig. 51

## 2. View LOG

The function includes the chronological list of the ALARMS LOG and the WASHING LOG.

The first list, ALARMS LOG, displays all of the errors that have been detected and shown on the oven display during its operation.

The second list, WASHES LOG, displays all of the washes and the type of wash performed by the oven, also showing the start date and time.

## 3. Advanced services

This function is password-protected and allows for access to the configuration, settings, and inspection functions reserved for the qualified technical staff.

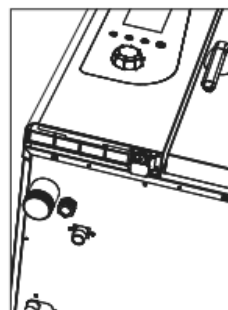

Fig. 52

#### 4. Import/export

If you insert a USB key next to the control panel (Fig. 52) and access the “Service” screen from the “Home” key, you can import and export some of the above-mentioned functions.

By connecting an EMPTY USB it is possible to EXPORT: RECIPE BOOK; HACCP LOG (this function, when enabled, records the cooking mode and all the relevant data: times, chamber temperature, core probe temperature, start and all the other phases, etc.) and the WASH LOG. After connecting a USB key containing for example new recipes, new parameters, or new languages, it is possible TO IMPORT this data into the oven software.



Fig. 53

#### 6. Cleaning and maintenance



##### CAUTION!

**Before cleaning disconnect the device from the power supply, close the water supply cut-off valve, and wait for complete cooling down of the oven chamber.**

**Never use pressurized water for washing the device!**

**Protect the device from the water penetration.**



##### CAUTION!

**Use only detergents suitable for combi steamer.**

**Use of unsuitable detergent may lead to damages of the cleaning system and oven chamber moreover the warranty will be invalidated.**

## 6.1 Regular cleaning by the user

- To ensure the device's proper functioning, hygiene and power, clean it at the end of every work day.
- Remove the rails from the device and wash them thoroughly in lukewarm water and gentle washing agent, rinse in clean water, and dry.



Fig. 54

- For washing the cooking compartment, use lukewarm water and appropriate cleaning agents. Rinse the compartment thoroughly with clean water and ensure no residue remains. Dry the cooking compartment.
- Use only special **stainless steel cleaning agents** as inappropriate chemicals may cause corrosion.
- Do not use cleaners containing chlorine (whiteners, hydrochloric acid, etc.).
- After cleaning use a soft, dry cloth to dry and polish the surface.

## 6.2 Humidity drain

The humidity drain removes vapours emitted in the oven chamber.

Make sure that it is not contaminated or clogged, clean it when required.

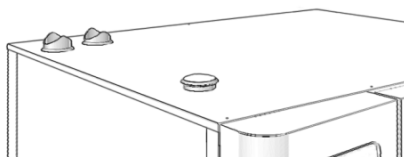

Fig. 55

### 6.3 Door cleaning

Double glazing facilitates cleaning. The internal glass may be opened when required.

To do this, turn the latch that holds the internal glass in place clockwise (Fig. 56). Tilt the internal glass.

Clean the internal glass on both sides and the device door with use of appropriate washing agent.

Do not use any aggressive and abrasive cleaning agents.

After cleaning close the internal glass and lock the latch in the initial position by turning it counterclockwise.



Fig. 56

### 6.4 Ventilation filter cleaning

The control panel ventilation filter (Fig. 57) must be cleaned at least once a month. It should be cleaned manually with use of water and soap solution.

To remove the filter pull it with your fingers to the outside, holding on both sides and pressing the appropriate catch.

It is good practice to replace the filter at least once a year or even more frequently when the oven operates in environments containing high concentration of flours or similar substances.

The filter must be replaced immediately when it is worn or damaged. It should be ordered as a spare part from the supplier.

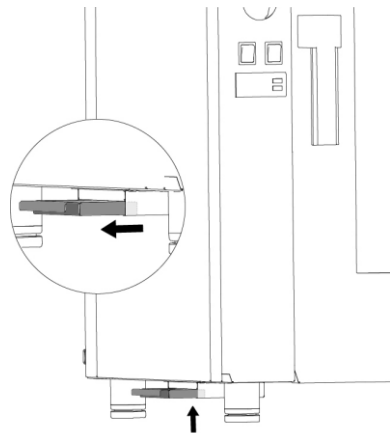

Fig. 57



## 6.5 Maintenance provided by the service technician

- Request regularly (**at least once a year**) the device maintenance performed by a qualified expert service technician. Contact the service office to do so.
- Before any maintenance work, disconnect the device from the power supply and close the water supply. Wait to let the device cool down.
- Before moving the device to another place make sure that the power supply and water supply are correctly disconnected.
- If the device is placed on a wheeled base, make sure that the electric wires, pipes or other elements are not damaged.
- After the operation has been performed and the device placed on a new place, make sure the electric and water supplies are connected in accordance with the legal requirements.

## 7. Description of alarms

If an alarm is triggered, its name is shown on temperature and time display.

The following alarms may occur:

Alarm/ Message	Description	Situation	Solution
<b>E01</b> -oven chamber sensor	Oven chamber sensor error	Cooking process interruption, automatic operation reactivation	Replace the oven chamber sensor
<b>E17</b> -core probe sensor	Core probe sensor error	Manual operation restoration	Replace the core probe sensor
<b>E05</b> -motor protection	Motor alarm	Cooking process interruption, manual operation reactivation	Reactivate the operation manually (press the knob); when alarm persists contact the service company
<b>E11</b> -motor protection 2	Motor alarm	Cooking process interruption, automatic operation reactivation	When alarm persists contact the service company

<b>Alarm/ Message</b>	<b>Description</b>	<b>Situation</b>	<b>Solution</b>
<b>E06</b> -oven chamber protection	Oven chamber thermal switch	Cooking process interruption, automatic operation reactivation	When alarm persists contact the service company
<b>E14</b> -Hi temp	Too high temperature of technical compartment	Cooking process interruption, automatic operation reactivation	Check cleanness of the ventilation filter, ventilation slots, and correct operation of fans cooling the components
<b>E21</b> -no water	No water for steam production	Cooking process interruption	Check water network connection, make sure that the water valve is opened
<b>E16</b> -Communication	PWM main card communication error	Cooking process interruption	Turn voltage off and on; when alarm persists contact the service company
<b>E22</b> -No power supply	Power outage	Cooking process interruption	Check electric power supply.

**If you cannot remove the malfunctions:**

- do not open the body,
- notify the customer service point or contact the sales agent, while providing the following information:
  - type of malfunction;
  - code number and serial number (see identification plate on device backside);
  - date of purchase.

## 8. Waste disposal

### Old devices



The electric devices are marked with this symbol. You must not dispose of electric devices with household waste. When the device may not be longer used each consumer is obliged to dispose of the device at the dedicated local collection point, separately from household waste.



### NOTE!

Electric devices should be used and disposed of properly to prevent the impact on the environment.

- Disconnect the device from the power supply and remove the power cord from the device.