

EN

Instructions for Use and
Maintenance

109251

CE

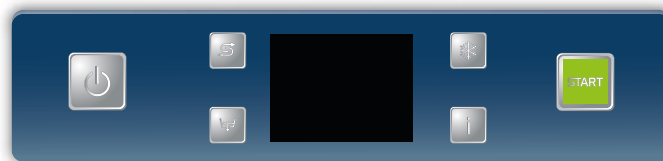



Thank you for choosing our machine.

The instructions for installation, maintenance and use found on the following pages have been prepared to ensure a long life and perfect operation of your unit.

Please, do follow the instructions carefully.

We have designed and built this machine using the latest innovative technologies. Now you shall take good care of it.

Your full satisfaction is our greatest reward.



READ THESE INSTRUCTIONS CAREFULLY BEFORE INSTALLING THE MACHINE.



WARNING: FAILURE TO COMPLY, EVEN PARTIALLY, WITH THE PRESCRIPTIONS IN THIS MANUAL WILL RENDER THE PRODUCT WARRANTY NULL, AND THE MANUFACTURER SHALL NOT BE LIABLE.

CONTENTS	Page
WARNINGS	33
1. MACHINE DESCRIPTION	35
1.1 Machine Description	35
1.2 Machine features	36
1.3 Dataplate	36
2. CONTROL PANEL AND RELATIVE SYMBOLS	37
2.1 Keys	37
2.2 Display	37
3. OPERATION	38
3.1 Machine start-up	38
3.1.1 Start-up	38
3.1.2 Start the wash cycle	38
3.1.3 Switching OFF	39
3.2 Cutlery and crockery loading	40
3.3 Detergent use	40
3.4 Rinse aid use	41
3.5 Drain pump system	42
3.6 Regeneration device (optional)	42
3.7 Extra cold rinse function (optional)	43
WARNINGS	44
4. ECOLOGICAL ASPECTS	45
4.1 Recommendations for optimal use of energy, water and additives	45
5. H.A.C.C.P. AND HYGIENE REGULATIONS	45
6. MAINTENANCE	46
6.1 Routine maintenance	46
6.2 Extraordinary Maintenance – by qualified Service Personnel only	46
7. MACHINE INSTALLATION	47
7.1 Handling	47
7.1.1 Handling the product	47
7.1.2 Storage	47
7.2 Prepare for installation	47
7.2.1 Room features	47
7.2.2 Electrical connection - Characteristics	47
7.2.3 Water supply connection - Characteristics	48
7.2.4 Water supply characteristics	48
7.2.5 Steam evacuation	48

7.3 Installation	49
7.3.1 Positioning the machine	49
7.3.2 Electrical connection	49
7.3.3 Water connection	49
7.3.4 Start-up	49
8. SIGNALS AND ALARMS	50
8.1 Signals	50
8.2 Alarms	50
9. ENVIRONMENTAL ASPECTS	55
9.1 Packaging	55
9.2 Disposal	55
10. TROUBLESHOOTING	55
11. EU DECLARATION	57



WARNINGS

This instructions booklet must be kept with the machine for future consultations. If the machine is sold or transferred to other users, make sure the booklet always goes with the unit so that the new owner can have all the necessary information on operations and all relevant instructions. The instructions booklet must be carefully read before installation and before starting the machine.

- **Adaptation of the electrical and water systems for dishwasher installation must only be carried out by qualified operators.**
 - The user shall not carry out any repair and/or maintenance operations. In any case contact qualified personnel.
 - Only qualified personnel can access the control panel, when the main power switch is OFF.
 - Servicing of this machine must be performed by authorized personnel only.
 - **N.B.: Use genuine spare parts only. Non-genuine parts will void the warranty and the manufacturer will take no responsibility for any damage.**
 - **Do not use old load pipe, but only new ones.**
 - Follow the instructions given in the manufacturer's booklet for cleaning operations (chap. 9).
 - This machine must only be used by adults. This is a professional machine to be used by qualified personnel, installed and repaired exclusively by qualified Technical Personnel. The Manufacturer declines any responsibility for improper installation, use, maintenance or repair.
 - This appliance can be used by trained youth aged from 15 years and above. It cannot be used by persons with reduced physical, sensory or mental capabilities or lack of experience and knowledge.
 - Children shall not play with the appliance.
 - Cleaning and user maintenance shall not be made by children without supervision.
 - **This machine must be disconnected from the main electrical supply after use at the end of the day and for any service/maintenance operation following this procedure:**
 - Switch the machine off from the control panel.**
 - Drain the tank.**
 - Disconnect the electrical supply by the omni-polar switch (main switch located on the wall).**
 - Shut the water supply valve(s).**
- Disregarding the aforesaid prescriptions is a serious misuse and can cause damages and injures to property and people, and will relieve the manufacturer from whatever liability.**



ATTENTION: INTERNAL CLEANING OF THE MACHINE SHALL BE CARRIED OUT AT LEAST 10 MINUTES AFTER THE POWER SWITCH HAS BEEN TURNED OFF.



ATTENTION: DO NOT INSERT HANDS AND/OR TOUCH THE PARTS LOCATED AT THE BOTTOM OF THE WASH TANK AND/OR AT THE END OF THE WASH CYCLE.

NOTE: The manufacturer declines any responsibility for accidents to people or any damage deriving from failure to observe the above listed instructions.

1. MACHINE DESCRIPTION

1.1 Machine Description

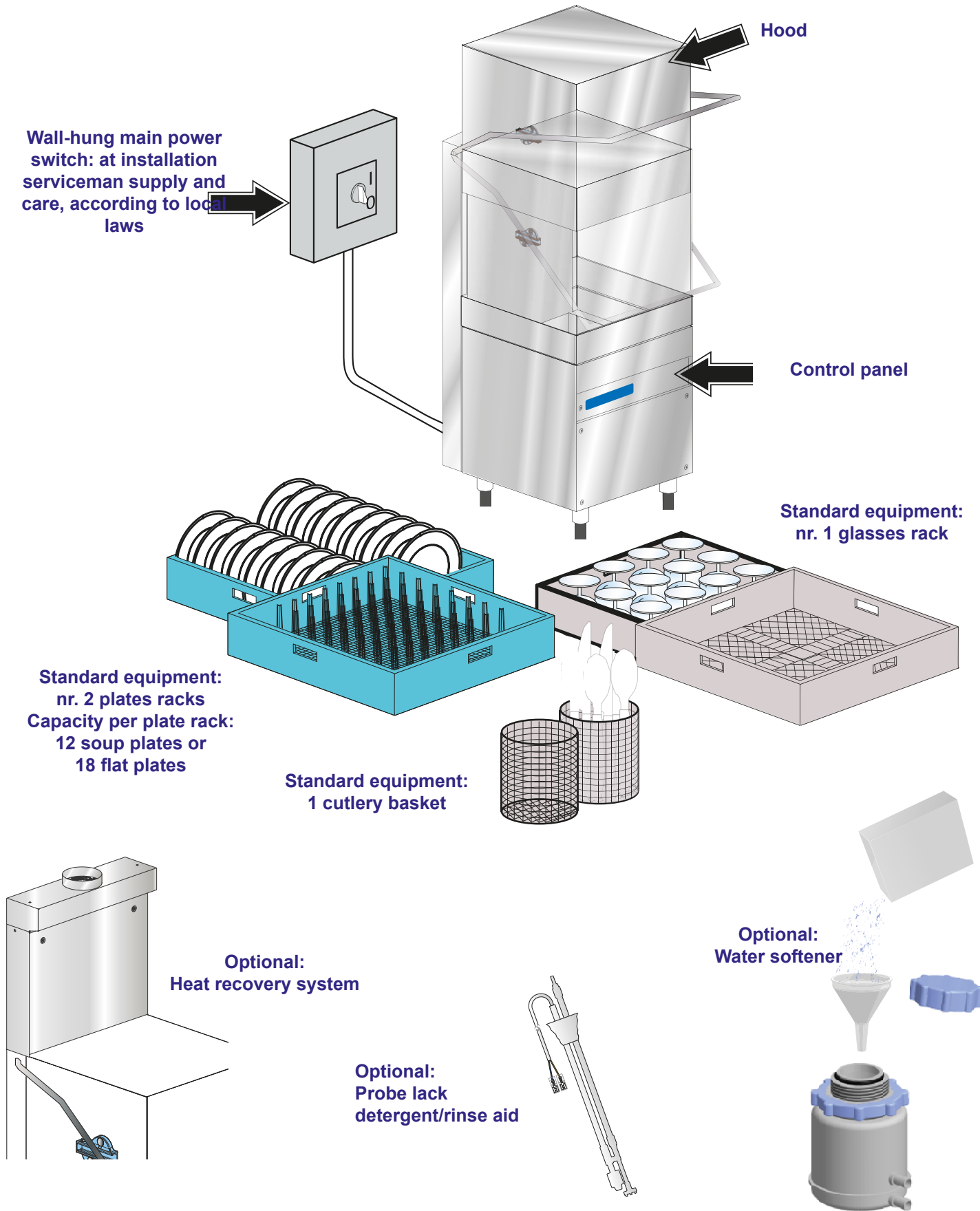

To operate the Hood machine, 3 connections are needed:

- Electrical;
- Water supply;
- Water drain.

This is a cycle machine comprising a 60°C wash cycle with detergent, a 82°C rinse cycle with injection of rinse-aid. 50x50 cm racks are used.

The machine can be complemented with wash-tables, rinse-showers and dedicated waste collection systems.

A new wash cycle can be started by closing the hood down.

The optional heat recovery system reduces significantly the humidity in the dishwashing-room, recovering the energy that is wasted from the roof, by condensation, by reducing the steam when the hood is opened.

1.2 Machine features

The machine’s sound level is $L_{pa} = 66,4\text{dBA} \pm 0,7\text{dB(A)}$ **

**test made according to EN 60335-2-58/A11

1.3 Dataplate

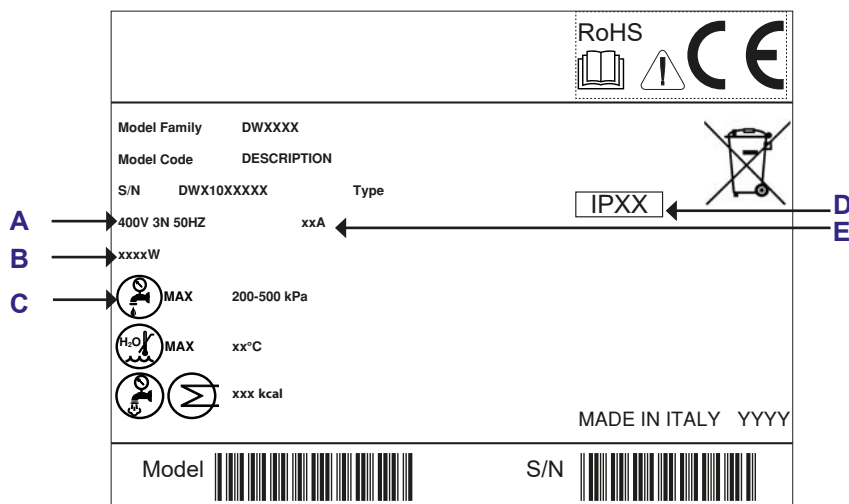

- A** Power source
- B** Total power installed
- C** Dynamic pressure
- D** Envelope protection degree
- E** Total electricity absorption

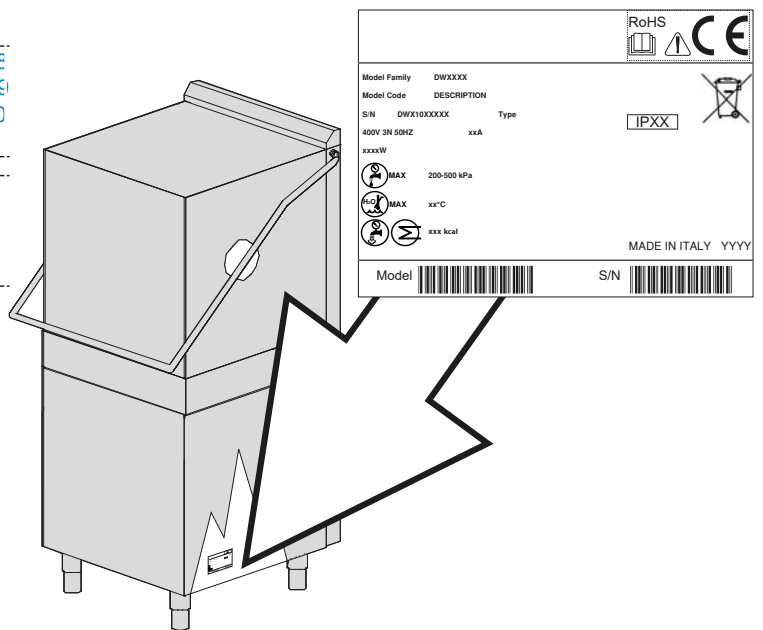
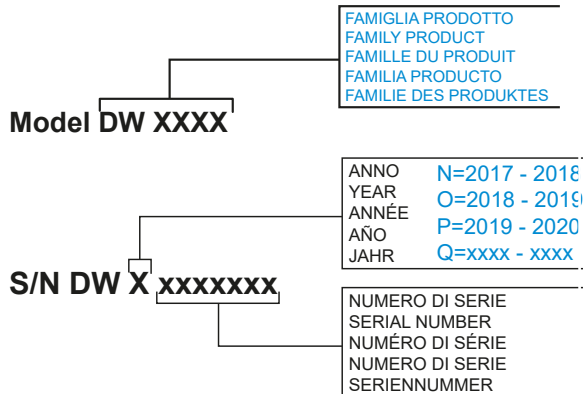

2. CONTROL PANEL AND RELATIVE SYMBOLS

2.1 Keys

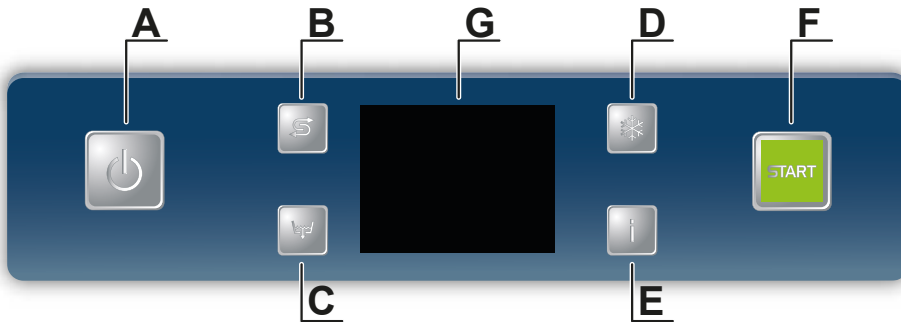

- A) Switching – On / STAND BY key
- B) Regeneration key (optional)
- C) Drain key
- D) Not available key
- E) Info key
- F) START key to start up cycle / select cycle
- G) Display

2.2 Display

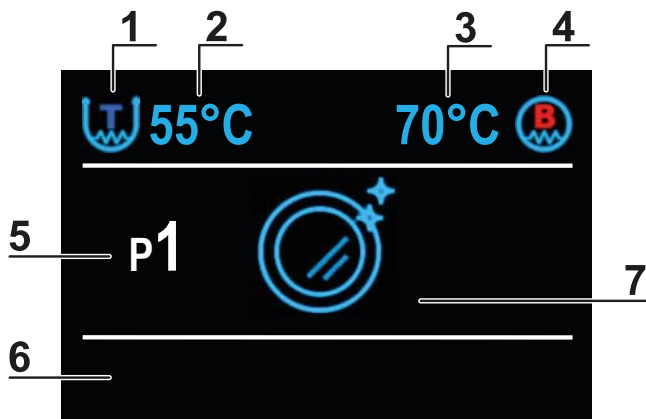

The display's indications, when machine ready, are listed below:

- 1) **Tank status icon**. If the letter **T** is red the heating element is ON.
- 2) Tank temperature
- 3) Boiler temperature
- 4) **Boiler status icon**. If the letter **B** is red the heating element is ON.
- 5) Cycle Code
- 6) Cycle Name
- 7) Cycle Icon

3. OPERATION

3.1 Machine start-up

3.1.1 Start-up

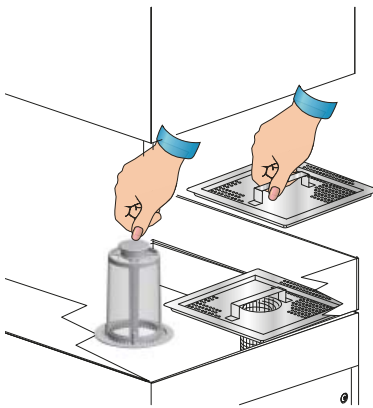

pict. 1

- Check if the pump suction filter is properly inserted in its seat in the wash-tank bottom (see pict. 1).

This filter must be cleaned every 20 wash-cycles or whenever necessary.

DO NOT use the appliance without the filters.

- Put the surface filters in place (see pict. 1).
- Shut the machine hood.
- Turn the water valve "open".
- Turn the main power switch ON.

• The machine is on **STAND-BY**. In the **G** display are shown: the symbol , the date and time and a possible notice of operations to be carried out by the user.

The key **A** turns red. The key **C** turns blue. If the machine is provided with the Water Softener optional also the key B turns blue.

- Press and hold the key **A**. The key **A** turns green.

• For the first 4 seconds the key **Start F** turns green and on the display **G** appears the last cycle carried out before switching the machine off. During this time it is possible to pre-select the cycle to start washing.

Keep pressed the key **Start F** to scroll the available cycles' list, until the desired one appears. Release the key. This function allows to save time in start-up phase if a cycle with lower operating temperatures is selected (i.e.: Rinse 70°C instead of 82°C). The key **Start F** turns red.

- If the tank was not drained after the previous use or if the tank water temperature is below 50°C, the machine proceeds with a tank draining. In any case remember that if the machine is not used the tank must be drained (see **WARNINGS**).

Even if the tank is empty the draining pump runs for a few seconds to eliminate any water residual.

- The machine proceeds to tank filling and heating, by steps. The display **G** alternatively shows the messages **FILLING WATER** and **HEATING**.

By pressing the key **Info E** it is possible to display the tank and boiler temperatures.

The machine is ready to wash when both tank and boiler are filled and the set temperatures are reached.

3.1.2 Start the wash cycle



- Insert the rack filled with dishes to wash (see paragraph 3.2). The plates must be correctly placed in the rack.

- If the desired cycle hasn't been selected before, it is possible to do it in this moment by keeping press the key **Start F**.

The display will show in sequence all these available programs.

Once the wanted program is displayed, do release the button.

Available programs:

Cycle Code	Cycle name	Icon	Total time*	Note
P0	CUSTOM		**	Partial drain cycle with adjustable time and temperatures
P1	SHORT WASH PROGRAM		50"	Partial drain cycle with rinse temperature at 82°C
P2	MEDIUM WASH PROGRAM		90"	
P3	LONG WASH PROGRAM		120"	
P4	INTENSIVE WASH PROGRAM		180"	
P5	XX INTENSIVE WASH PROGRAM		300"	

*The indicated time is valid only if the machine has reached the boiler temperature set.

The cycle **P0 is a customizable cycle according to the user's needs, to be set by a technician during the machine installation.

- Close the hood; the wash cycle starts automatically. To restart a suspended wash cycle, press the key **Start F**. The display shows a percentage indicating the cycle progress. On the lower part of the display is shown the phase of the cycle (wash, drain or rinse). The key **Start F** turns blue.
- If the hood is open, the key **Start F** lights in red and the cycle can not be started. By pressing the key **Start F** the display indicates **DOOR OPEN**.
- Keep pressed the key **Start F** for about 2 seconds to stop the cycle. The percentage is reset if the cycle is stopped.
- At the end of the cycle the key **Start F** alternatively flashes in blue/green. The display shows the 100% value and, the message **CYCLE ENDED** on the lower part.

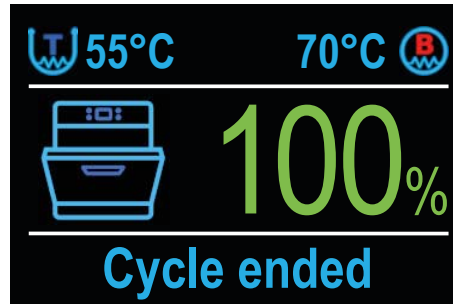
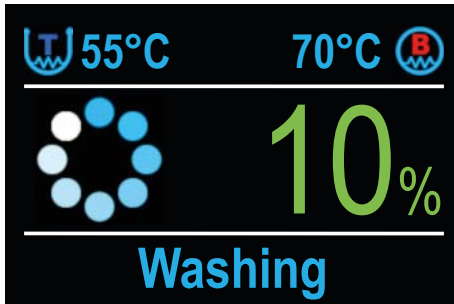

If enabled, a buzzer signals the end.

Keep the hood closed in order to avoid and reduce cooling down during stand-by periods.

Note: At cycle-end, keeping the hood closed, dishes will not dry. Take out the rack or keep the hood open to allow evaporation, helping the drying of the dishes.

Note: We recommend to change the tank water, by means of another filling, at least twice a day, or whenever needed.

The machine is set to change all the wash-water automatically, every 100 cycles.

3.1.3 Switching OFF

- Keep pressed the key **A** until it lights in red.
- Drain completely the wash tank by pressing the key **C** which activates the drain pump (see paragraph **3.5**).
- At the end of the day, clean the machine (see chap. **6 Maintenance**).
- Shut the water valve.
- Switch the main power switch OFF.

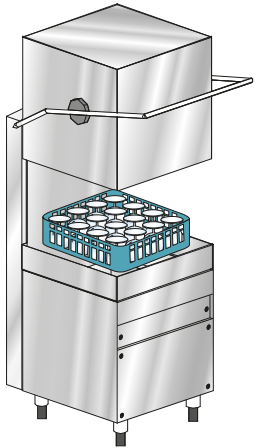

pict. 2

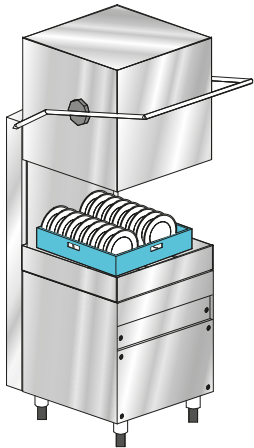

pict. 3

3.2 Cutlery and crockery loading

Before cutlery and crockery loading in the machine, coarsely clean them from the leftover food. It isn't necessary to rinse the cutlery and crockery under water.

ATTENTION: Do not wash articles polluted with petrol, paint, chips of steel or iron, ash, sand, wax, lubricant grease. These substances damage the machine. Do not wash fragile objects or material not resistant to the washing process.

Note the following recommendations:

- Crockery and cutlery should not be inserted inside one another, covering each other.
- Place the crockery in order to all surfaces can be reached by water; otherwise the dishes are not washed.
- Make sure all the crockery are in a stable position and that the hollow containers don't overturn (cups, glasses, bowls, etc.) .
- Place in the rack all the hollow containers such as cups, glass, etc. **upside-down**.
- Place the crockery with deep hollow with upper face downwards, so that water can flow out.
- Make sure the smaller crockery do not fall from the rack.
- Check all the wash arms runs freely and they are not blocked by too tall or too prominent crockery. Eventually, run a manual rotation of the arms to check it.

Some foods, such as carrots, tomatoes, and others, may contain some natural dyes substances, that in large amounts, can alter the crockery and plastic parts colors. Any discoloration does not mean that the plastic is not heat resistant.

Crockery and cutlery not suitable for dishwasher

Not suitable for dishwasher:

- Wooden crockery and cutlery or with wooden parts; water at high temperature causes deformation to wood. Also the adhesives used are not suitable for treatment in the dishwasher; a consequence could be the handles detachment.
- Crafts, precious vases or decorated glasses.
- Not heat-resistant plastic crockery.
- Copper, brass, pewter or aluminum objects: they may become discolored or opaque.
- The decorations on glass, after a certain number of washes, can lose gloss.
- Fragile glasses or crystal items, if often washed, can become opaque.

We recommend to buy exclusively crockery and cutlery suitable for dishwashing.

After several washes, the glass can become opaque.



It is mandatory to repeat the washing cycle if at the end of the cycle the crockery are not well clean or if there are washing residues (glasses, cups, bowls, etc. with liquid inside).

3.3 Detergent use

The machine has a standard detergent dispenser. The machine automatically sucks the detergent.

The detergent shall be the NO FOAM type, suitable for industrial dishwashers.

The use of good quality liquid detergents is recommended.

Follow the manufacturer's recommendations for chemical dosage, related to the local water hardness.

A correct amount of detergent is very important for a successful wash.

Should the detergent lack, the display shows **DETERGENT LEVEL** (only with optional "Sensor for Chemicals Low Level").

A buzzer sounds at one minute intervals.



By pressing the key **Info E** the display goes back to machine ready status. The signal becomes scrolling in the display's lower part alternatively to the cycle name. The signal remains until the detergent tank is refilled.

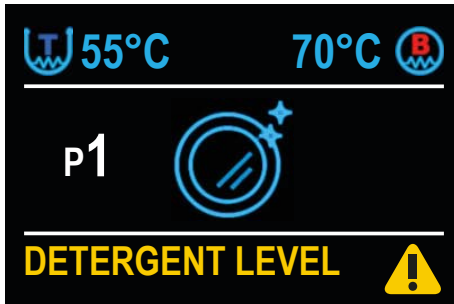

3.4 Rinse aid use

The machine has a standard rinse aid dispenser. The machine automatically sucks the product.

The rinse-aid chemical, shall be suitable for professional glass and dishwashers. It is advisable to rely on specialized retailers in the sector.

Should the detergent lack, the display will show **RINSE-AID LEVEL** (only with optional "Sensor for Chemicals Low Level"). A buzzer sounds at one minute intervals.



By pressing the key **Info E** the display goes back to machine ready status. The signal becomes scrolling in the display's lower part alternatively to the cycle name. The signal remains until the detergent tank is refilled.



3.5 Drain pump system

The machine is standardly equipped with a drain pump. It regulates the tank water level during wash cycles. At the end of the working day it drains the tank.

To proceed with a draining, both with machine ON and stand-by mode, press the key **C** until the display shows the message **TANK DRAINING**.



With the hood closed, the key **Start F** is blue and flashes.

After the draining is complete, the machine will turn automatically in **STAND-BY** mode.

3.6 Regeneration device (optional)

Should the machine be equipped with a water-softener circuit, this will be fully automatic.

When needed, a 120" regeneration cycle will automatically activate. During this phase, the display will show the letter **R** (at the bottom, on the right side).

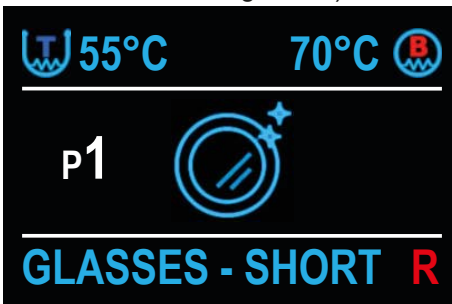

If needed, the cycle can be activated even during the wash-tank loading. **If the activation happens during the wash-cycle, this will be elongated.**

The circuit board is programmed to call periodically for a 20 minutes manual complete regeneration cycle. When the display shows **PRESS WATER SOFTENER REGENERATION KEY** (scrolling message at the bottom of the display) start the following procedure:

- To start a complete regeneration cycle, with the machine in **STAND-BY** mode and the hood shut, keep pressed the key **B** for about 3 seconds. The key **Start F** is blue and flashes.
- During the cycle the display shows the cycle phases and the percentage indicating the cycle progress.
- This cycle cannot be interrupted and the normal operation is inhibited.
- At the cycle end, the machine switches in **STAND-BY** mode, automatically.

Note: To carry out a correct regeneration cycle it necessary the salt container inside the tank has salt in it. In case of salt lacking the user is advised with the message **SALT LEVEL** and a buzzer sounds at regular intervals.



By pressing the key **Info E** the display goes back to machine ready status. The signal becomes scrolling in the display's lower part alternatively to the cycle name.

The signal remains until the salt container is refilled.

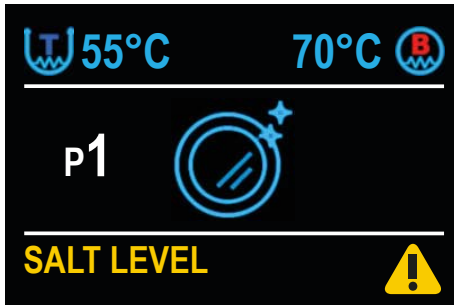

To add salt, open the machine hood and unscrew the salt container plug inside the tank.

Fill the special container with specific coarse salt for regeneration (1-4 mm), being careful not to spill it into the tank. A strong concentration of salt can negatively affect the correct functioning and service life of the machine and generate rust and the steel corrosion. After filling with salt, lock the plug tightly.

In case of water hardness above 35°f an external water softener is recommended.

3.7 Extra cold rinse function (optional)

Should the machine be equipped with a **Extra cold rinse** (optional) feature, and it is enable, after the normal rinse cycle an extra cold rinse is made for about 10 seconds with tap water.

To start the optional cycle, with machine ON, press the key **D**.

The display shows the relative symbol .

The optional cycle is active until the key **D** is pressed again. At this moment the icon disappears.



WARNINGS:

- Do not slam the hood when opening and closing.
- Do not put material or objects on the machine.
- The machine has an IP (see serial number label on the machine) protection rating against accidental water splashes and is not protected against pressurized water jets. Pressure-cleaning systems shall, therefore, not be used on this machine.
- Do not dip bare hands into water containing detergent. If this should occur, wash them immediately with plenty of water. Check the safety instructions on the detergent container.
- Some important rules must be followed for using this appliance:
 - 1) never touch the appliance with wet hands or feet;
 - 2) never use the appliance when barefooted;
 - 3) do not install the appliance in places exposed to water splashes.
- **This machine must be disconnected from the main electrical supply after use at the end of the day and for any service/maintenance operation. Switch off the main switch located on the wall, which shall be installed by a professional installer. Shut the water supply valve(s).**
- Do not cover the intake or dissipation grids.
- Do not use water to extinguish fires on electrical parts.

WARNING: INTERNAL CLEANING OF THE MACHINE SHALL BE CARRIED OUT AT LEAST 10 MINUTES AFTER THE POWER SWITCH HAS BEEN TURNED OFF.

WARNING: DO NOT INSERT HANDS AND/OR TOUCH THE PARTS LOCATED AT THE BOTTOM OF THE WASH TANK AND/OR AT THE END OF THE WASH CYCLE.



4. ECOLOGICAL ASPECTS

4.1 Recommendations for optimal use of energy, water and additives

Salt dosing: A pre-set (by the manufacturer) quantity of salt is injected in the resins at each regeneration cycle. It is important to observe the number of regeneration cycles recommended in paragraph **3.6 Regeneration device** in order to avoid salt spills or lime deposits.

Use the machine fully loaded when possible: This shall prevent detergent, rinse aid, water and energy consumption waste.

Detergent and rinse-aids: Use detergents and rinse-aid chemicals with high biodegradability, to best respect the environment. Verify proper dosage in relation to water hardness at least three times a year. Excess product pollutes rivers and seas while an insufficient dose results in unsatisfactory dish washing and/or hygiene.

Boiler and Wash-Tank temperatures: The boiler and tank temperatures are set by the manufacturer in order to obtain the best washing results with detergents on the market. The temperatures can be reset by the installer in relation to your detergent.

Pre-washing: Carefully pre-wash with a moderate amount of water at room temperature to facilitate the removal of animal fats. To remove encrusted materials warm water soaking is recommended.

Note: Wash objects as soon as possible to avoid deposits from drying and compromise effective washing.

For effective washing routine dishwasher cleaning and maintenance is advised (see chap. **6**).

Disregarding the points listed above and of any the information contained in this manual can cause energy, water and detergent waste with a subsequent increase in running costs and/or performance reduction.

5. H.A.C.C.P. AND HYGIENE REGULATIONS

- When starting the machine ON, no wash-cycle will be starting until the set boiler and wash-tank temperatures are reached. During operation, the machine will not start the rinse cycle till the set boiler temperature is reached.
- Remove carefully all solids from the objects to be washed, to avoid obstruction of filters, nozzles and piping.
- Drain the wash tank and clean the filters at least twice a day.
- Check if the detergent and rinse-aid dosage are correct (as recommended by the manufacturer). In the morning, before starting the machine, check that the quantity of chemicals in the canisters is enough for daily supply.
- Keep your working tables clean.
- Extract the rack with clean hands or gloves to avoid finger marks.
- Do not dry or polish the washed objects with cloths, brushes or rags that are not sterile.



6. MAINTENANCE

6.1 Routine maintenance

WARNING: The machine is not protected against pressurized water jets. Do not use pressure cleaning system against the machine.

It is recommended to contact the seller of chemicals for proper cleaning instructions, in order to have detailed indications on methods and products for the correct periodical machine sanitation.

Do not use bleach or chlorine based detergents.

Daily cleaning is needed to ensure that the machine runs perfectly. The following shall be carried out:

- Turn the machine in **STAND-BY** mode, by pressing the button **A** (see chap. 2).
- Remove the surface filters and clean them under running water. Drain the sump water (see paragraph 3.5).
- Remove the pump filter and clean with a brush and a water shower (see pict. 4).
- Remove the arms by loosening the fixing screws, and thoroughly clean them, and the wash and rinse slots under running water (see pict. 4).



pict. 4

- Reassemble the parts and reposition the wash pipes firmly in place.
- Clean the tank very carefully, using a water shower.
- It is suggested to leave the hood of the machine open at the end of the day.

Automatic cycle of machine self-cleaning/rinsing: recommended at each day end.

Machine in **STAND-BY** mode, the scrolling message **SELF-CLEANING: REMOVE FILTERS AND PRESS START** appears on the lower part of the display.

Remove the filters.

Shut the hood.



Push the button **Start F**. A wash chamber and heat recovery (if present) automatic self-cleaning cycle will start, after this the machine will be in **STAND-BY**. The message **SELF-CLEANING CYCLE OVER** appears.

- Shut the water valve.
- Turned the machine off by switching the main power switch OFF.

Note: This operation allows the complete draining of the boiler, in order to remove any air bubbles, which may cause malfunctions.

6.2 Extraordinary Maintenance – by qualified Service Personnel only



Once or twice per year, the machine should be checked by qualified Service Personnel:

- 1 Clean the intake filter of the solenoid valve
- 2 Remove scaling from the heating elements
- 3 Check the status and the tightness of all gaskets
- 4 Check the perfect state and/or wear of the components
- 5 Check the efficiency of the dispensers
- 6 Tighten firmly all electrical connections.

7. MACHINE INSTALLATION

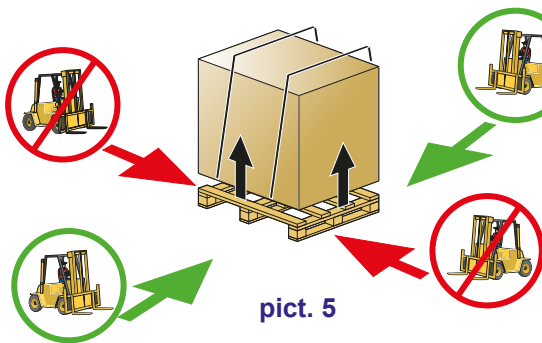

7.1 Handling

7.1.1 Handling the product

The machines must be handled strictly as shown in pict. 5 regarding the grip points indicated for lifting with a lift truck.

Latch the machine in a way that secures no vibration or shocks during transportation.

N.B.: Slings with ropes not recommended.

After unpacking, make sure the appliance has not been damaged due to transportation. If it has been, do notify the seller about this problem. If the damage might question the machine's safety, do not install the appliance.

Double check the firm tightness of all hose-clamps on piping, nuts and bolts, and fasteners, that might come loose with the transport, to prevent water dripping or leakages, or other damages, during the machine's operation.

See chapter **9 ENVIRONMENTAL ASPECTS** for disposal of the packing material.

7.1.2 Storage

Storage temperature: min. +4°C - max +50°C - humidity <90%.

The stored parts should be checked periodically, to detect any sign of deterioration.

Do not put anything on the machine, even if packed in its box.

7.2 Prepare for installation

This is just a guide-line for the machine installation.

The installation must be performed by a qualified engineer.

7.2.1 Room features

Install the machine, in a room closed to weather and with a guaranteed temperature-range between 5 and 35°C.

The machine is equipped with thermostatic sensors to manage the temperatures. To guarantee a proper functionality these sensor shall not operate at a room temperature below 5°C.

For this reason, it is fundamental that before starting the machine reaches the room temperature.

7.2.2 Electrical connection - Characteristics

The electrical connection to network shall be carried out in accordance to the local laws in force.

Make sure that the supply voltage is the same as reported on the machine plate and that the network can stand the needed power absorption shown on the same plate.



A suitable omni-polar one-way switch shall be installed and sized according to the absorption provided, in order to completely guarantee the disconnection from the supply mains, under "category III" overvoltage conditions.

This switch shall be included in the power network solely and exclusively used for this purpose and installed in the immediate vicinity of the machine.

Always turn the machine off via this switch. This is the only model of switch that guarantees a total electrical power disconnection.

Make sure that the facility is equipped with efficient ground connection.



WARNING: check very carefully if the "ground connection" of the machine, is properly sized and fully efficient, and that not too many units are connected on it. An undersized or poor "ground connection" might lead to corrosion and/or pitting effect on the stainless steel plates, even to perforation.

7.2.3 Water supply connection - Characteristics

Fresh water supply features:

Table 1

Water characteristics table	Min	Max
Static Pressure	200Kpa	400Kpa
Dynamic Pressure*	150Kpa	350Kpa
Water hardness**	2°f	8°f
Cold water-supply temperature***	5°C	50°C
Hot water-supply temperature****	50°C	60°C
Capacity	10l/min	

*Should the water supply pressure be more than 400 kPa, a pressure reducer must be installed (only for those versions where it is not a standard supply, already).

****It is compulsory to install a water-softener, in case of water with average hardness above 8°f.** Washed objects will be cleaner and the machine will last much longer.

The machine can be equipped with a water softener, on request. If the machine is equipped with a water-softener, a regeneration of the resins shall be done on regular basis (see par. **3.6 Regeneration device**).

N.B.: Any damage caused by limestone (calcareous water higher-up than 8°f and without water-softener) will not be covered by warranty.

A periodical check of the supplied water hardness is highly recommended.

*****The machine must be supplied with cold water, if equipped with the Heat Recovery System (min 5°C - max 15°C).**

Machines shall be made with extra power in case of cold water infeed.

****The water supply temperature shall never exceed 55°C.

The drain tube shall always be connected to a siphon in order to prevent the release of odors.

Maximum drain height = cm. 50.

7.2.4 Water supply characteristics

The machine water supply must be potable, in compliance with Directive 98/83/EC.

The inlet water must also meet the parameters given in the table 2.

Table 2

Water parameters table	Min	Max
Chlorine ¹		2mg/l
pH	6,5 ¹	8,5 ³
Water hardness		8°f ²⁻³
Iron ³		0,2 mg/l
Manganese ⁴		0,05 mg/l
Conductivity ⁵	200µS/cm	

¹ Out of range values might lead to corrosion and jeopardize the life of the machine.

² Should the water hardness is higher **it is compulsory** to install a water softner and check periodically its operation.

³ Out of range values might lead scaling and sediments with a consequent lower performance, functionality, and expected life of the machine.

⁴ Desired value: Out of range values might lead stainless steel blackening/tarnishing.

⁵ For machines equipped with Heat Recovery System.

It is recommended a water test once a year.

7.2.5 Steam evacuation

In accordance with regulations of environmental hygiene, for the proper functioning of the machine and a healthy environment for the operator who working in there, it should be at least 10 air volume changes per hour in the room where the machine is installed.

For small wash rooms we recommend at least 15 air volume changes per hour.

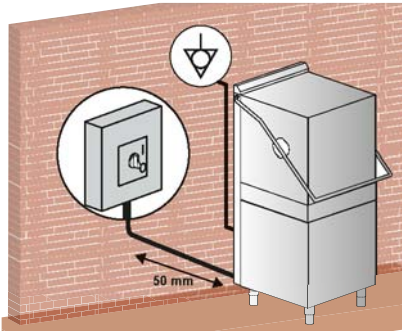

pict. 6

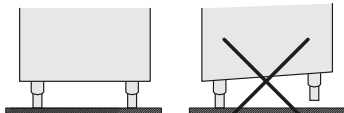

pict. 7

7.3 Installation

7.3.1 Positioning the machine

Remove the packing with care.

Lift the machine as described in par. 7.1.1 **Handling the product**.

Position the machine as shown on the installation diagram (lay-out) approved at the time of the offer.

Maintain a minimum distance of about 50 mm from the walls, so that motors are ventilated (see pict. 6). Install suction hoods to assure proper ventilation of the room, in order to eliminate steam and excessive humidity.

Check that the machine is properly levelled, by adjusting the legs.

Make sure the machine is not standing on the power cable or on the filling/drain hoses. Level the machine flat, by adjusting the support feet (see pict. 7).

7.3.2 Electrical connection

The electrical connection shall be carried out in accordance to the local laws in force.

The machine has a connection at the back, indicated by the symbol , that is meant to link the steel structure and masses among different apparatuses, to prevent electro-static electrical shocks.

The electrical supply cable must be new, flexible, and according to "har" H07RN-F or a local valid equivalent. The cable size is dimensioned according to the power.

If the machine is fitted with a three-phase pump, check the correct motor rotation (right rotation as per arrow on the casing). This is not needed if the pump is a single-phase model (standard).

7.3.3 Water connection

Connect the machine draining hose to the connection located at the bottom, laterally.

The drain tube shall always be connected to a siphon in order to prevent the release of odors.

Maximum drain height = cm. 50 (see pict. 8).

In those machines equipped with "water softener" the water supply temperature shall not exceed 40°C, to avoid damages to the filters' resins.

7.3.4 Start-up

At installation engineer's care.

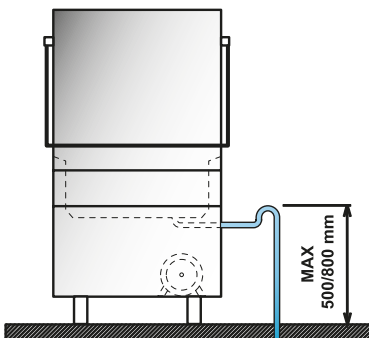

pict. 8



8. SIGNALS AND ALARMS

8.1 Signals

The signal messages are displayed based upon their meaning. They do not block the machine. The signals remain visible until the operator executes the necessary actions.

Signals with machine in stand-by mode:

When **PRESS WATER SOFTENER REGENERATION KEY** appears on the display it means that a total regeneration is needed (only on machines equipped with the optional Water Softner).

When **SELF-CLEANING: REMOVE FILTERS AND PRESS START** appears on the display it means that it is suggested to start a Self-cleaning cycle.

When **SELF-CLEANING CYCLE OVER** appears on the display it means that the machine has ended the Self-cleaning cycle.

Signals with machine switch on:

When **DETERGENT LEVEL** appears on the display it means that the detergent is over (only on machines equipped with the optional "Chemicals level Sensor").

When **RINSE-AID LEVEL** appears on the display it means that the rinse aid is over (only on machines equipped with the optional "Chemicals level Sensor").

When **SALT LEVEL** appears on the display it means that the salt level in the bowl is low (only on machines equipped with the optional Water Softner).

When **DOOR OPEN** appears on the display it means that you are trying an operation that cannot be done with the hood door.

When **DRAIN WATER IN WASH TANK** appears on the display it means that you are trying an operation that cannot be done with the wash tank full.

When **FLOWMETER FAIL** appears on the display it means that the water flowmeter is not connected or is disabled (only on machines equipped with the optional "Flowmeter").

8.2 Alarms

The alarms are displayed, based upon their meaning.

By pressing the key **E** the current alarm information is displayed.

TYPE OF ALARM	CAUSE
B1	BOILER FILLING FAIL
B2	BOILER PROBE FAIL.
B3	BOILER HEAT. ALARM
B4	RINSING FAILED
B5	BOILER OVERHEATING
B8	BOILER PRESSURE SWITCH
B9	BOILER SAFETY THERMOSTAT
E1	WATER LOAD FAILED
E2	TANK PROBE FAIL.
E3	TANK HEATING ALARM
E5	TANK OVERHEATING
E6	TANK DRAINING FAIL.
E7	WASH PUMP THERMAL RELAY
E8	TANK SAFETY THERMOSTAT
Z4	TANK SENSOR FAILURE
Z5	TANK HIGH LEVEL
Z6	TANK LOW LEVEL
Z9	REGENERATION FAIL
Z10	ALARM SL8

Table 3

ALARM-B1**BOILER FILLING
FAIL****B1 BOILER FILLING FAIL:**

Cause: The machine boiler fill-up was not achieved in the maximum foreseen time limit.

Remedies: Open the water supply valve and verify a proper water supply flow. Contact Technical Service.

ALARM-B2**BOILER PROBE
FAIL.****B2. BOILER PROBE FAIL.:**

Cause: The circuit board does not detect the boiler sensor.

Remedies: Contact Technical Service.

ALARM-B3**BOILER HEAT.
ALARM****B3. BOILER HEAT. ALARM:**

Cause: The factory-set boiler temperature was not achieved in the maximum foreseen time limit.

Remedies: Contact Technical Service.

ALARM-B4**RINSING FAILED****B4. RINSING FAILED:**

Cause: The rinse water was not used during the rinse cycle.

Remedies: Contact Technical Service.

ALARM-B5**BOILER
OVERHEATING****B5. BOILER OVERHEATING:**

Cause: The water temperature in the boiler exceeded 105°C.

Remedies: Contact Technical Service.

ALARM-B8**BOILER PRESSURE
SWITCH****B8. BOILER PRESSURE SWITCH:**

Cause: The circuit board does not detect the pressure-switch or the pressure-switch failed.

Remedies: Contact Technical Service.

ALARM-B9**BOILER SAFETY
THERMOSTAT****B9. BOILER SAFETY THERMOSTAT:**

Cause: The boiler safety thermostat is tripped.
Remedies: Contact Technical Service.

ALARM-E1**WATER LOAD
FAILED****E1. WATER LOAD FAILED:**

Cause: The machine wash-tank was not filled in the maximum foreseen time limit.
Remedies: Open the water supply valve. Contact Technical Service.

ALARM-E2**TANK PROBE
FAIL.****E2. TANK PROBE FAIL.:**

Cause: The circuit board does not detect the wash-tank sensor.
Remedies: Contact Technical Service.

ALARM-E3**TANK HEATING
ALARM****E3. TANK HEATING ALARM:**

Cause: The factory-set wash-tank temperature was not achieved in the maximum foreseen time limit.
Remedies: Contact Technical Service.

ALARM-E5**TANK
OVERHEATING****E5. TANK OVERHEATING:**

Cause: The wash-tank temperature exceeded 90°C.
Remedies: Contact Technical Service.

ALARM-E6**TANK DRAINING
FAIL.****E6. TANK DRAINING FAIL.:**

Cause: The draining of the wash-tank was not completed within the maximum foreseen time limit.
Remedies: Contact Technical Service.

ALARM-E7**WASH PUMP
THERMAL RELAY****E7. WASH PUMP THERMAL RELAY**

Cause: The wash pump(s) motor is blocked.
Remedies: Contact Technical Service.

ALARM-E8**TANK SAFETY
THERMOSTAT****E8. TANK SAFETY THERMOSTAT:**

Cause: The tank safety thermostat is tripped.
Remedies: Contact Technical Service.

ALARM-Z4**TANK SENSOR
FAILURE****Z4. TANK SENSOR FAILURE:**

Cause: The circuit board does not detect the pressure-switch or the pressure-switch failed.
Remedies: Contact Technical Service.

ALARM-Z5**TANK HIGH LEVEL****Z5. TANK HIGH LEVEL:**

Cause: The tank pressure-switch detects an excessively high level of water in the tank.
Remedies: Drain and load the tank. Contact Technical Service.

ALARM-Z6**TANK LOW LEVEL****Z6. TANK LOW LEVEL:**

Cause: The tank pressure-switch detects a too low level of water in the tank.
Remedies: Contact Technical Service.

ALARM-Z9**REGENERATION
FAIL****Z9 REGENERATION FAIL (on machines equipped with the optional Water Softener):**

Cause: The salt sensor does not work properly.
Remedies: Contact Technical Service.

ALARM-Z10**ALARM SL8****Z10 ALARM SL8 - BREAK TANK HIGH LEVEL (on machines without the optional Water Softener)**

Cause: The Break Tank safety pressure-switch detects a high level.

Remedies: Contact Technical Service.

9. ENVIRONMENTAL ASPECTS

9.1 Packaging



Packaging is made of the following components:

- a wooden pallet;
- a nylon sack (LDPE);
- a multi-layer carton;
- polystyrene (PS) strips;
- polypropylene (PP) banding.

All above materials, shall be disposed and treated in accordance with the Local Laws in force.

9.2 Disposal



The symbol WEEE/RAEE used on this product indicates that it cannot be treated as domestic waste. Proper disposal of this product contributes to protecting the environment. For more information on product recycling, contact the local authorities, domestic waste authorities or the dealer where the product was purchased.

For product or parts disposal, follow the Council directives 2011/65/UE and 2012/19/UE as amended and/or application legislative decrees.

The present product or parts cannot be disposed of as urban waste but shall be collected in separate containers (see the waste bin on wheels symbol with an "X" on the product).

At the time of product disposal, the user shall refer to the waste electrical and electronic equipment (WEEE/RAEE) specification. The manufacturer guarantees the absence of dangerous substances in the EEA used in conformity to the directive 2011/65/UE. If the user does not comply with the regulations he/she shall be subject to the penalties foreseen by each member state.

Disconnect electricity and water before disposal.

Cut away the electrical cable to ensure that further use is impossible.

All metal parts are recyclable as they are made of stainless steel.

Recyclable plastic parts are marked with the plastic material symbol.

10. TROUBLESHOOTING



Type of Problem	Possible Causes	Cure
The machine does not turn on	Main switch not ON.	Turn switch ON.
The machine does not load water.	Water valve shut.	Open the water valve.
	Rinse slots or solenoid-valve filter blocked and/or scaled with limestone.	Clean the rinse arm slots, piping and solenoid-valve filter. If the machine is equipped with a water softener check the salt content or regenerate the resins more often
	Defective pressure-switch.	Replace pressure-switch.
Cycle indicator - START button F flashing (red colour)	See chapter 8 Alarms .	---
Washing results are unsatisfactory.	The washing slots are obstructed or the rack does not rotate.	Remove the wash rack and clean the wash slots
	Foam is present	Use no-foam detergents or reduce the dose in use.
	Fats or starches not removed.	Insufficient detergent concentration.
	Filters are dirty.	Remove filters, clean with brush under a jet of water and replace in original position.
	Check tank temperature (which must be between 55°C and 60°C).	Check correct heating element operation.
	Wash time insufficient for the type of dirt.	Select a longer wash-cycle, if possible, otherwise repeat the wash cycle.
	Wash water is dirty.	Drain the tank water, clean the filters; refill the tank and replace the filters correctly.

Type of Problem	Possible Causes	Cure
Objects are not properly dried	Not enough rinse aid.	Increase dosage by turning the dispenser screw (call for Service).
	The rack is not suitable for the objects	Use the suitable rack which gives the objects an inclined position so that water can rinse away.
	The washed items may have been sitting in the wash chamber too long.	As soon as the cycle stops, remove the rack with pots and tools so that they can dry more quickly in the air.
	Rinse water temperature too low	Check the boiler temperature
	Surface of dishes and glasses too rough or porous for material wear.	Replace type of dishes and glasses used. If the dirt on the dishes is dry and old, soak before washing.
Streaks and spots on objects.	Too much rinse-aid chemical.	Reduce the rinse aid amount. Contact the Technical Assistance
	Too hard water.	Check the water quality. Water must not exceed 2-8°f in hardness.
	For appliances with softener: too little salt in the salt container or the resins have not been properly regenerated.	Fill the salt container (coarse salt: 1-4 mm grains) and regenerate the resins more often. If lime deposits are also observed on the body of the machine, have a qualified technician check the operation of the water softener.
	Salt present in dishwasher sump.	Thoroughly clean and rinse the appliance, and avoid spilling salt when filling the container.
The machine suddenly stops during operation.	The machine is connected to an overload device.	Contact the Technical Assistance
	A machine safety device was triggered.	Check the electrical devices. Contact the Technical Assistance
The machine stops during the wash stage and starts refilling water.	The previous day's water was not changed.	Drain the tank totally and refill.
	Excessive water temperature in tank.	Check the temperature and eventually reduce it. Contact the Technical Assistance
	Defective pressure switch.	
The washing pump doesn't work	The pump is blocked	Contact the Technical Assistance

**N.B.: For any other question, please contact your Service provider.
The manufacturer has right to modify any technical characteristics without prior notice.**

11. EU DECLARATION

The machine purchased is in compliance with the norms stated in the EU declaration attached to the machine in original. Please find attached below the facsimile of this declaration, with the general data of the machine purchased. For the absorption data refer to the data-plate on the machine.

DICHIARAZIONE DI CONFORMITA' UE
EU DECLARATION OF CONFORMITY
DÉCLARATION EU DE CONFORMITÉ
EU-KONFORMITÄTSEKTLÄRUNG
DECLARACIÓN EU DE CONFORMIDAD
DECLARAÇÃO EU DE CONFORMIDADE



Il sottoscritto (1), autorizzato dall'azienda (2), dichiara che la lavastoviglie elettrica per uso collettivo (3) è stata progettata e costruita in conformità alle norme armonizzate (4) secondo quanto prescritto dalle seguenti direttive e successivi emendamenti (5) e in applicazione a quanto previsto dalle direttive citate, è stata dotata di Marcatura CE e sono stati predisposti i fascicoli tecnici presso la nostra sede (2). Tale dichiarazione riguarda esclusivamente la macchina nello stato in cui è stata immessa sul mercato, escludendo i componenti aggiunti e/o le operazioni effettuate successivamente dall'utente finale. Declina ogni responsabilità per sinistri a persone, a cose o ad animali derivanti da manomissione della macchina da parte di terzi, ovvero da carenze di manutenzione, di riparazione o di installazione della stessa da parte di personale non qualificato. (*)

The undersigned (1), authorized by the company(2), hereby declares that the commercial electric dishwashing machine (3) is in compliance with the harmonised standards (4) according to the following directives and further amendments (5) and pursuant of the above mentioned directives, the CE Marking have been applied. Furthermore, adequate technical files have been prepared and are available at our offices (2). This declaration relates exclusively to the machinery in the state in which it was placed on the market, and excludes components which are added and/or operations carried out subsequently by the final user. Declines all responsibility for damages to people, properties and animals resulting from bad servicing of the machine by third parties as from inadequate maintenance or repairs or installation by unskilled technicians.

Le soussigné (1), désigné par la société (2), déclare que le lave-vaisselle électrique à usage collectif (3) est conforme aux normes harmonisées (4) selon les prescriptions et directives suivantes et les amendements successifs (5) et en application des directives citées, il porte le Marquage CE. Les dossiers techniques sont déposés dans notre siège (2). Cette déclaration concerne exclusivement la machine dans l'état dans lequel elle a été mise sur le marché et exclut les composants ajoutés et/ou les opérations effectuées par la suite par l'utilisateur final. Décline toute responsabilité pour tout sinistre à personnes, choses ou animaux résultant de l'endommagement de la machine par un tiers, c'est-à-dire dû à une maintenance, des réparations ou une installation inadéquates effectuées par du personnel non-qualifié.

Der Unterzeichnete (1) berechtigt von der Firma (2), erklärt, daß die elektrischen Spülmaschinen für den gewerblichen Gebrauch (3). In Übereinstimmung mit den harmonisierten Normen ist (4) gemäß folgender Richtlinien und deren nachfolgenden Änderungen (5) und daß in Übereinstimmung mit den erwähnten Richtlinien die CE-Kennzeichnung angebracht wurde und daß die relevanten technischen Unterlagen zusammengestellt wurden (2). Diese Erklärung bezieht sich nur auf die Maschine in dem Zustand, in dem sie in Verkehr gebracht wurde; vom Endnutzer nachträglich angebrachte Teile und/oder nachträglich vorgenommene Eingriffe bleiben unberücksichtigt. Jede Verantwortung für an Personen, Sachen und Tieren verursachten Schäden, die durch die Manipulation seitens Dritten, beziehungsweise auf mangelhafte Wartung und Reparaturarbeiten oder Installation von unqualifiziertem Personal zurückzuführen sind, werden abgelehnt.

Quien subscribe (1), elegido de la empresa (2), declara que el lavavajilla eléctrico de uso colectivo (3) es conforme a las normas armonizadas (4) como la prescripción de la siguientes directivas y sucesivas enmiendas (5) y, conforme con lo previsto en las citadas directivas, han recibido el Marcado CE. Existe asimismo los específico expediente técnico relativo disponible en nuestro domicilio (2). Esta declaración se refiere únicamente a las máquinas en el estado en que se comercialicen, con exclusión de los elementos añadidos y/o de las operaciones que realice posteriormente el usuario final. Declina toda responsabilidad por daños a personas, cosas o animales producidos del mal servicio de la máquina por terceras partes así como por reparaciones o mantenimiento inadecuados o de instalaciones por parte del personal no cualificado.

O abaixo-assinado (1), autorizado pela empresa (2), vem por este meio declarar que a máquina de lavar louça para uso comercial (3) esta de acordo com as normasharmonizadas (4) de acordo com o previsto pelas seguintes diretivas e posteriores alterações (5) a Marcação CE foi aplicada no seguimento das diretivas mencionadas. Os processos técnicos estão preparados e adequados e encontram-se disponíveis na nossa sede (2). Esta declaração diz respeito apenas à máquina tal como se encontra no momento da colocação no mercado, excluindo-se os componentes adicionados e/ou as operações efectuadas posteriormente pelo utilizador final. Declina toda e qualquer responsabilidade por danos causados a pessoas, bens e animais, resultantes do mau manuseamento da máquina por parte de terceiros assim como manutenção incorrecta ou reparações inadequadas ou instalação por pessoal não qualificado.

(*) **Lingua originale / Original language / Originalsprache / Langue originale / Idioma original / Idioma original**

2)	3)
4) EN 60335-1:2012; EN 60335-2-58:2005; EN 55011:2009; EN55014:2006; EN 61000 3-2:2006; EN 61000 3-3:2008; EN61000 3-11:2000; EN 61000 3-12:2005; EN 61000 4-2:2009; EN61000 4-4:2010; EN 61000 4-5:2006; EN 61000 4-6:2009; EN61000 4-11:2004	5) 2014/30/EU; 2006/42/EC; 2011/65/EU; 2012/19/EU
1) Preposto/Person in Charge	Firmato in originale e conservato presso la nostra sede (2). Original document signed and available at our office (2). Dieses Dokument ist im Original unterzeichnet und bei uns aufbewahrt (2). Signé en original et gardé à notre siège (2). Firmado en original y conservado en nuestro domicilio (2). Original assinado e armazenado na nossa sede (2).