

**WEH1500**



**109901**

Bartscher GmbH  
Franz-Kleine-Str. 28  
D-33154 Salzkotten  
Germany

Phone: +49 5258 971-0  
Fax: +49 5258 971-120  
**Service hotline:** +49 5258 971-197  
[www.bartscher.com](http://www.bartscher.com)



Version: 1.0

Date of preparation: **2023-12-01**

---

## Original instruction manual

1	Safety .....	2
1.1	Explanation of Signal Words .....	2
1.2	Safety instructions.....	3
1.3	Intended Use .....	5
1.4	Unintended Use .....	5
2	General information .....	6
2.1	Liability and Warranty .....	6
2.2	Copyright Protection .....	6
2.3	Declaration of Conformity .....	6
3	Transport, Packaging and Storage .....	7
3.1	Delivery Check.....	7
3.2	Packaging .....	7
3.3	Storage .....	7
4	Technical Data.....	8
4.1	Technical Specifications .....	8
4.2	List of Components of the Appliance .....	9
4.3	Functions of the Appliance.....	10
5	Installation and operation .....	15
5.1	Installation.....	15
5.2	Electrical Connection .....	20
5.3	Operation .....	20
5.4	Settings.....	23
6	Cleaning and Maintenance .....	28
7	Possible Malfunctions .....	28
8	Disposal.....	30



**Read this instruction manual before using and keep it available at all times!**

This instruction manual contains information about installation, operation and maintenance of the appliance and constitutes an important source of information and reference guide. The knowledge of all operational and safety instructions included in this manual is a prerequisite for safe and proper handling of the appliance. Additionally, accident prevention, occupational health and safety, and legal regulations in force in the area the appliance is used apply.

Before you start using the appliance, especially before turning it on, read this instruction manual in order to avoid personal injuries and property damages. Improper use may cause damage.

This instruction manual forms and integral part of the product and must be stored in an immediate vicinity of the appliance and be available at all times. The instruction manual should be transferred together with the appliance.

## 1 Safety

This appliance has been manufactured in accordance with technical standards currently in force. However, the appliance may be a source of hazards if used improperly or contrary to its intended purpose. All persons using the appliance must consider information included in this instruction manual and observe safety instructions.

### 1.1 Explanation of Signal Words

Important safety instructions and warning information are indicated in this instruction manual with appropriate signal words. You must strictly follow the instructions, to prevent accidents, personal injuries and property damages.



**DANGER!**

The signal word **DANGER** warns against hazards that lead to severe injuries or death if the hazards are not avoided.



**WARNING!**

The signal word **WARNING** warns against hazards that may lead to moderate or severe injuries or death if the hazards are not avoided.



### CAUTION!

The signal word **CAUTION** warns against hazards that may lead to light or moderate injuries if the hazards are not avoided.

### IMPORTANT!

The signal word **IMPORTANT** indicates possible property damages, which may occur if safety instructions are not observed.

### NOTE!

The symbol **NOTE** indicates subsequent information and guidelines for the user on usage of the appliance.

## 1.2 Safety instructions

### Electrical Current

- Too high a mains voltage or incorrect installation may cause electric shock.
- The appliance may be connected only if data on the rating plate correspond with the mains voltage.
- To avoid short-circuit, the appliance should be kept dry.
- If there are malfunctions during operation, disconnect the appliance from the power supply.
- Do not touch the appliance's plug with wet hands.
- Never take hold of the appliance if it has fallen into water. Immediately disconnect the appliance from the power supply.
- Any repairs or housing opening may be carried out by professionals and relevant workshops only.
- Do not transport the appliance, holding it by the power cord.
- Do not allow the power cord to come into contact with heat sources or sharp edges.
- Do not bend, pinch nor knot the power cord.
- Always completely unwind the power cord.
- Never place the appliance or other objects on the power cord.
- Always take hold of the plug to disconnect the appliance from the power supply.

- Check the power cord regularly for damage. Do not use the appliance if the power cord is damaged. If this cable is damaged, it must be replaced by customer service or a qualified electrician in order to avoid dangers.

## Operating Personnel

- The appliance may only be operated by qualified personnel and trained specialist personnel.
- This appliance may not be operated by persons (including children) with limited physical, sensory or mental capabilities, nor by persons with limited experience and/or limited knowledge.
- Children should be supervised to ensure that they are not playing with or switching on the appliance.

## Improper Use

- Unintended or prohibited use may cause damage to the appliance.
- The appliance may only be used when its technical condition is flawless and allows for safe operation.
- The appliance may only be used when all connections are executed according to rules of law in force.
- The appliance may only be used when it is clean.
- Use only original spare parts. Never attempt to repair the appliance on your own.
- Do not introduce any changes in the appliance nor modify it.

### 1.3 Intended Use

As described below, every use of the appliance for a purpose differing and/or diverging from its intended standard use, is prohibited and considered to be an unintended use.

The following is an intended use:

- Reduces limescale build-up in an appliance and on washed items by reducing water hardness.

### 1.4 Unintended Use

An unintended use may lead to personal injuries or property damages caused by hazardous voltage, fire or high temperature. The appliance may only be used to perform tasks described in this instruction manual.

## 2 General information

### 2.1 Liability and Warranty

All information and instructions in this instruction manual account for legal regulations in force, current level of technical engineering knowledge as well as our expertise and experience, developed over the years. If special models or additional options are ordered, or state-of-the-art technical solutions were implemented, the actual scope of delivery of the appliance may, in some circumstances, differ from descriptions and numerous drawings in this instruction manual.

The manufacturer is not liable for any damages nor faults stemming from:

- failure to observe instructions,
- unintended use,
- technical alterations introduced by the user,
- usage of unapproved spare parts.

We reserve the right to introduce technical modifications to the product, intended for improvement of the appliance and its performance.

### 2.2 Copyright Protection

This instruction manual, and texts, drawings and images included in it, as well as its other components are copyright protected. It is prohibited to reproduce this instruction manual (including its excerpts), in any form and by any means, and to use and/or transfer its content to third parties without manufacturer's written permission. Violation of the above results in obligation to pay compensation. We reserve the right to claim further damages.

### 2.3 Declaration of Conformity

The appliance meets the currently applicable standards and guidelines of the European Union. We confirm the above in the EC Declaration of Conformity. We may provide relevant Declaration of Conformity upon request.



## 3 Transport, Packaging and Storage

### 3.1 Delivery Check

Immediately upon reception, check the delivery for completeness and possible shipping damage. In the case of visible transport damage refuse to accept the appliance or accept it conditionally. Mark and note the scope of damage in shipping documents/consignment list of the shipping company and lodge a complaint.

Concealed damage must be reported immediately upon its discovery, as compensation claims may only be filed within applicable time limits.

If you find that parts or accessories missing, please contact our Customer Service Department.

### 3.2 Packaging

Do not dispose of the appliance cardboard box. It may be used to store the appliance when relocating or when shipping the appliance to our service point in the case of any damages.

The packaging and its elements are made of recyclable materials. Particularly, these are: plastic films and bags, cardboard box.

When disposing of the packaging, observe applicable domestic regulations. Recyclable packaging materials should be recycled.

EN

### 3.3 Storage

Leave the packaging closed until installation of the appliance; observe external indications concerning method of placing and storage. Store the packaging in the following conditions only:

- in closed rooms;
- in dry and dust-free surrounding;
- away from aggressive agents;
- in a location protected against sunlight;
- in a location protected against mechanical shocks.

In the case of extended storage (over three months), make sure you check the condition of the packaging and the parts regularly. If needed, replace the packaging with a new one.

## 4 Technical Data

### 4.1 Technical Specifications

<b>Name:</b>	<b>Water softening system WEH1500</b>
Art. No.:	<b>109901</b>
Material:	plastic
Output capacity:	1.500 litres/day at 10° dH (total hardness)
Water connection:	3/4"
Water temperature at inlet, in °C:	1 - 30
Connection capacity, appliances:	1
Return value per cartridge:	0
Operating pressure:	2 - 6
Salt stock in brine tank, in kg:	20
Salt consumption, in kg / regeneration:	0,7
Regeneration duration, in min:	45
Dimensions (W x D x H), in mm:	238 x 465 x 478
Weight, in kg:	9,2

We reserve the right to implement technical modifications.

#### Version / Characteristics

- Designed for: industrial dishwashers
- Digital display
- Setting options:
  - interval
  - hour
  - day of the week
  - water hardness
  - regeneration
- Regeneration: flow rate or period

## 4.2 List of Components of the Appliance



EN

Fig. 1

- |                                       |                     |
|---------------------------------------|---------------------|
| 1. Control valve with digital display | 2. Filter cartridge |
| 3. Brine tank cover                   | 4. Brine tank       |
| 5. Housing                            | 6. Connections      |

## 4.3 Functions of the Appliance

### How the Appliance Works

Hard water contains a combination of calcium (Ca), magnesium (Mg) and iron (Fe). Softening is used to remove positively charged ions using an ion exchange resin. When the ion exchange resin loses its effectiveness, it is activated through a regeneration process.

### Regeneration

Regeneration is carried out by rinsing the sludge with a salt solution and flushing the absorbed calcium and magnesium ions into the wastewater.

Regeneration is carried out automatically in an intelligent, logical way: based on the water consumption of the previous 7 days, the system itself selects the day of regeneration at the set time. During regeneration (60 min), unsoftened water is available.

The **regeneration process** consists of 4 cycles:

1. Regenerating agent replenishment
2. Rinsing with the regenerating agent solution
3. Backwashing
4. Quick rinsing

### Water Softening System Structure

The system is configured for 0.7 kg of regenerating agent per regeneration. The amount of water softened between regenerations is calculated with the formula:

$$Z = 1350 \times 10 / Y$$

Z — means the amount of softened water between regenerations,

Y — means the hardness of the tested water based on dH (German degrees of hardness).

Example of calculation of the amount of softened water between regeneration processes:

The tested water hardness is 15°dH.

The amount of water Z between regeneration processes is calculated as follows:

$$Z = 1350 \times 10 / 15 = 900 \text{ litres.}$$

With a water hardness of 15°dH, 900 litres of softened water will be obtained.

**Water Hardness Performance Table (°)**

Degree of hardness				Softened water (L)
English hardness	French hardness	PPM	German hardness	
12,5	18,0	178,6	10	1500
13,8	19,8	196,5	11	1364
15,0	21,6	214,3	12	1250
16,3	23,4	232,2	13	1154
17,5	25,2	250,0	14	1071
18,8	27,0	267,9	15	1000
20,0	28,8	285,8	16	938
21,3	30,6	303,6	17	882
22,5	32,4	321,5	18	833
23,8	34,2	339,3	19	789
25,0	36,0	357,2	20	750
26,3	37,8	375,1	21	714
27,5	39,6	392,9	22	682
28,8	41,4	410,8	23	652
30,0	43,2	428,6	24	625
31,3	45,0	446,5	25	600
32,5	46,8	464,4	26	577
33,8	48,6	482,2	27	556
35,0	50,4	500,1	28	536
36,3	52,2	517,9	29	517
37,5	54,0	535,8	30	500
38,8	55,8	553,7	31	484
40,0	57,6	571,5	32	469
41,3	59,4	589,4	33	455
42,5	61,2	607,2	34	441
43,8	63,0	625,1	35	429
45,0	64,8	643,0	36	417
46,3	66,6	660,8	37	405

47,5	68,4	678,7	38	395
48,8	70,2	696,5	39	385
50,0	72,0	714,4	40	375

Tab. 1

### Standards, Rules and Regulations

- The water used to supply the appliance must be of drinking water quality and conform to the requirements of the regulations for the use of water of the public utility at a site.
- All parts in contact with the treated water must be made of waterproof material.
- Ensure that a soil drainage is installed at the water treatment site. The purchaser is responsible for the drainage.
- The maximum temperature of the supplied water should not exceed 30°C.
- Do not remove the water softening system during use.
- Do not open the water softening system, otherwise the warranty will be voided.

### Control Function

#### Control Valve

Before starting, set the current time and water hardness in degrees.

The valve is set by default to regenerate at 2:00 AM at 20 German degrees.

#### Salt Replenishment Reminder

The system automatically detects the salt level in the brine tank each time after regeneration. If the salt level is below normal, the low salt sensor will relay this to the intelligent control system, and a "SALT" alarm will be displayed in the screen.

The buzzer will sound daily from 7:30 PM to 10:30 PM to remind the user to replenish the salt.

Salt should be replenished on time to avoid using unsoftened water. When the display shows the "SALT" alarm, the salt in the brine tank can be used for 2 or 3 more regenerations.

#### Bypass

The bypass connection allows for convenient installation and maintenance. There are three different types of states when the bypass handle is rotated.

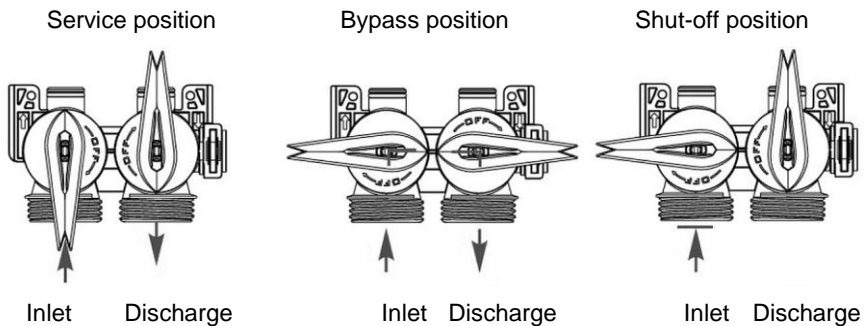

Fig. 2

#### DRY Brine Tank

The system fills the brine tank each time just a few hours before regeneration to keep the brine tank largely dry, preventing salt from accumulating above the tank or leaking out.



#### INTELLIGENT Control

- The water softening system is equipped with the latest intelligent control valve, described below.

**Upflow regeneration system.** Unlike downflow systems, a water softening system with the upflow system directs the water flow upward. Water flows from the bottom of the brine tank in an upward swirling motion through the resin. The upflow system is a high-efficiency system. Thanks to regeneration with the water stream directed upward, the system can use 30% less salt.

**Proportional regeneration.** The system regenerates the used resin only according to the water consumption condition. This saves salt and keeps the resin fresh.

**Holiday mode** When the system is not going to be used for a long time, the holiday mode can keep the resin fresh. Holiday mode can be activated by

pressing and holding the  button in softening mode until HOLIDAY appears in the display. To switch the holiday mode off, press the  button until the HOLIDAY message is no longer displayed.

- If the control valve does not detect water consumption greater than 6 LPM (litres per minute) or 85 LPD (litres per day) in the next 4 days, the control valve will initiate 100% regeneration at the set time of the 4th day, and then remain in standby mode in the operating position.
- If the control valve does not detect water consumption greater than 6 LPM (litres per minute) or 85 LPD (litres per day) in the next 4 days, the controller will only perform a 5-minute backwash and quick rinse at the programmed time on the 2nd and 4th day, respectively.
- If the control valve detects water consumption greater than 6 LPM (litres per minute) or 85 LPD (litres per day), the holiday mode is discontinued and the control valve switches to normal mode based on previous conditions. The amount of water consumed is added via the control valve to the records.



### 5 Installation and operation



#### CAUTION!

**Incorrect installation, positioning, operation, maintenance or misuse of the appliance may lead to personal injury or property damage.**

Positioning and installation, as well as repairs may be performed by authorised technical service only and in compliance with the applicable national law.

#### NOTE!

**The manufacturer disclaims all liability and provides no warranty for damages, which may be attributed to non-observance of regulations or incorrect installation.**

### 5.1 Installation

#### Information for Installer

EN

- All installation and maintenance work on the water softening system must be performed only by trained and authorized specialized personnel.
- Unpack the appliance and discard the entire packing material. Never remove the rating plate or any warning signs from the appliance.
- Before installing the water softening system, the appliance working with it (dishwasher) must be free of lime and gypsum deposits.
- Do not install the appliance in the vicinity of heat sources and open flames. Protect the appliance from sunlight.
- Protect the appliance from mechanical damage.
- If the water pressure in the water supply line exceeds 6 bar, it is necessary to install a pressure reducer to the appliance.
- Accessories for the water softening system in contact with water must be made of material suitable for this purpose.
- All parts must be installed in accordance with the country's guidelines for the installation of drinking water systems.
- The ambient temperature at the installation site must be at least 10°C.
- Protect the appliance from frost.

- The installation site of the appliance must be protected from damage caused by water (e.g., by an existing floor drain). The manufacturer is not responsible for damage caused by water.

### **ATTENTION!**

**After storage and transportation at temperatures below 0°C, the appliance must be kept in its open original packaging for at least 24 hours before it is put into operation at the specified ambient temperature.**

### **Preparation for Installation**

The user must make the following preparations at the installation site

1. Water supply line with 3/4" connection and shut-off valve.
2. Water discharge line (sewer) with a maximum height of 100 mm, DN50 connection.
3. Socket 230 V / 50 Hz, 16 A.
4. Floor drain in the installation room.
5. Mechanical fine filter must be installed upstream of the system.

### Installation Diagram

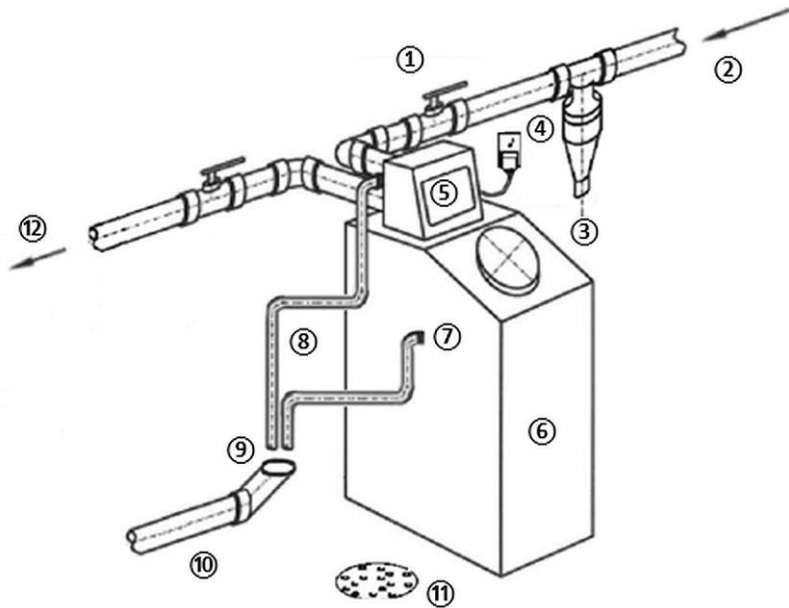

EN

Fig. 3

- |  |                               |
|--|-------------------------------|
| 1. Water supply line with 3/4" connection and shut-off valve | 2. Cold water supply          |
| 3. Mechanical cleaning filter                                | 4. Electrical socket          |
| 5. Control valve   | 6. Brine tank                 |
| 7. Overflow drain elbow                                      | 8. Flexible regeneration hose |
| 9. Air gap   | 10. Sewage network            |
| 11. Floor drain  | 12. Softened water            |

### Water Softening System Installation

1. After preparation for installation, place the appliance in the designated room according to the installation plan.
2. Connect all supply and drain lines. The appliance's connections are shown in the following figure:

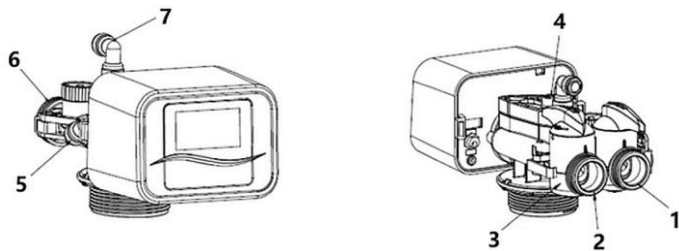

Fig. 4

- Connect the water supply line (2) and drain pipe (1) to the appliance.
- Connect the flexible sewage pipe (1/2") to the connection pipe (5) and to the drain or sewage system.

#### ATTENTION!

**The sewage pipe must be large enough to allow 5 l/m of rinse water to drain. The drain pipe must be rigid enough not to break and lead to blockages and overflowing of the brine tank, as well as to the malfunction of the regeneration process.**

- A mechanical fine filter should be installed in front of the water softening system to protect the appliance from mechanical damage caused by sediment from water pipes.
- Fill the brine tank of the water softening system with salt tablets.
- Then add 3 litres of water.
- Check all connections to the appliance and tighten them if necessary.
- Connect the water softening system to a single grounded outlet.

### Disassembly and Disposal

At the end of its life, the appliance will be disassembled (for final destruction or scrapping).

Disassembly should be done in reverse order.

#### **ATTENTION!**

**First, thoroughly clean the system with clean drinking water and completely empty the tanks and hoses!**

**Observe health and safety regulations when doing so!**

### Preferred Settings

The appliance is pre-set at the factory. Precise adjustment is done by user on site.

1. Program the control valve (section 5.4).
2. Before commissioning, set the current time and water hardness in German degrees of hardness.
3. Check the water hardness and enter the correct value.

Based on this, the system will calculate the capacity after which regeneration should begin. The control valve is set by default so that regeneration takes place at 2:00 AM at 20 degrees of water hardness according to the German scale.

4. Open the water supply to the water softening system.

The water pressure must be at least 2.0 bar and a maximum of 6.0 bar.

5. Vent the system, starting the regeneration process. Start the regeneration by pressing the  (EXIT) button for 5 seconds.

There will be an audible buzzing of the electric motor, indicating that regeneration is in progress. During the regeneration process, the system is ventilated and the brine tank is filled with water. Immediately after regeneration is complete, the appliance is ready for operation again. Hard water is available during regeneration.

### 5.2 Electrical Connection

- Verify if the technical specification of the appliance (see the rating plate) corresponds to the characteristics of the local electric mains grid.
- Connect the appliance to a single, properly grounded mains socket with a protective contact. Do not connect the appliance to a multi-socket.
- The power cord should be laid in a way preventing anyone from threading on it or tripping against it.

### 5.3 Operation

#### Display Messages

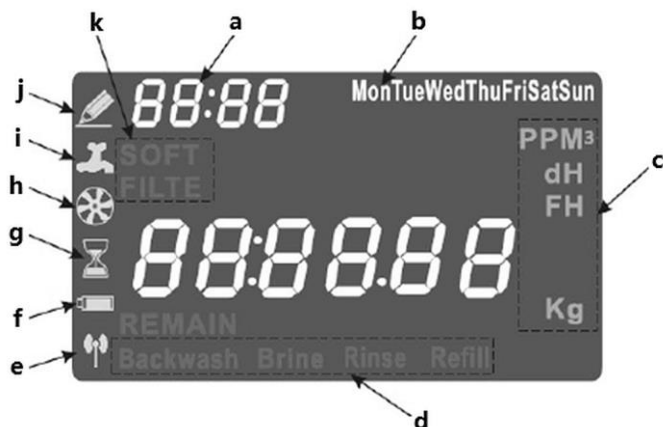

Fig. 5

**a – current time**

**b – information about the day of the week**

**c – appliance:** M3 – flow rate; PPM, dH, FH – water hardness unit, dH – German hardness, FH – French hardness, Kg – total resin replacement capacity.

**d – cycle stage:** When this message flashes, it means that the control is moving to the current cycle stage.

**e – wireless control:** When this message appears, it means that the wireless unit can control the valve.

**f – backup battery:** The battery is installed. When this message flashes, it means that the battery level is low.

## Installation and operation

**g – queue regeneration:** The initiation of queue regeneration means that the controller is currently in the process of regeneration.

**h – flow meter:** When the flow meter is installed and flashing, it means that the flow is going through the meter.

**i – appliance is running:** If flashing, it means that the controller is moving to the operating position.

**j – setting mode:** At the controls in the data settings.

**k – valve type:** SOFT – softening valve, FILTE – filter valve.

### Control Keys



Fig. 6



#### Time programming menu

Short press – enter user settings



#### Entering

Approval and saving of current settings



#### Increase button

Increase setting value



#### Decrease button

Decrease the value of the settings



#### Exit

1. Short press in programming mode – return to previous setting step
2. Long press (5 sec) – regeneration starts immediately
3. Short press in softening mode – forces regeneration to start at the programmed time.

### Backup battery – connection and functions

#### NOTE!

The backup battery is not included in the scope of supply.

A 9 V 6LR61 block battery is required for the appliance.

To extend the life of the battery, connect the battery only when the control valve is properly set.



Fig. 7

1. Remove the cover from the battery socket.
2. Slide the battery terminal onto the battery.
3. Then place the battery in the battery socket.

#### Functions:

- When the power is switched off in the operating position, the control valve remains in the same position, even after reaching regeneration. The battery, processor and flow meter operate normally. The skipped regeneration will be made up as soon as the power supply is restored.
- When there is a power failure during the regeneration stage, the control valve battery remains on, and the control valve completes the current stage and moves it back to the operating position, where it waits for electrical power to be restored. It then returns to the operating position to continue and complete the remaining regeneration stages to be executed.



### 5.4 Settings

#### Settings

The appliance is pre-set at the factory. The default language is German.

To set other options, follow the setting steps in the table below or contact the service department.



Fig. 8



1. To enter the setting mode, press the  button.
2. In the home screen, press the  button to set the time.



Fig. 9

The hours indicator starts flashing.

3. Press the  or  button to set the hours.
4. Press the  button to save the setting.

EN



Fig. 10

The minutes indicator starts flashing.

5. Press the  or  button to set the minutes.
6. Press the  button to save the setting.



Fig. 11



Fig. 12



Fig. 13





Fig. 14



The day of the week indicator starts flashing.

7. Press the  or  button to set the day of the week.
8. Press the  button to save the setting.

The overrun day indicator starts flashing.

9. Press the  or  button to set the overrun day.
10. Press the  button to save the setting.

The regeneration time indicator starts flashing.

11. Press the  or  button to set the regeneration time.
12. Press the  button to save the setting.

When the maintenance time arrives, the informal indicator and alarm will alternate in the screen.



Fig. 15





Fig. 16



Fig. 17

13. Press the  button to abort the alarm and return to the home screen.

The water hardness indicator starts flashing.

14. Set the degree of water hardness (dH) on the inlet by pressing the  or  button.

15. Press the  button to save the setting.

The electric power indicator flashes.

16. Press the  button to switch the acoustic signal off when connected to the electric power supply.



Fig. 18



Fig. 19

17. In the home screen, press the  button for 3 seconds to activate the holiday mode.

A message appears in the display as shown on the left.

18. Press the  button again to switch the message off.

### Manual regeneration initiation

19. Press the  button in the home screen for 5 seconds.

The control valve initiates regeneration immediately.

Press the  button again to proceed to the next stage of the cycle.

EN

### Automatically Detect and Store System Errors

The control valve automatically displays all detected system errors and warns the user via the display. The details are as follows:



Fig. 20

Output position cannot be located



The optical sensor does not receive a signal

Fig. 21



The electric motor is blocked or locking the wrong starting position

Fig. 22



Digital display is not well connected to the control valve (cable and radio)

Fig. 23

## 6 Cleaning and Maintenance

1. Check the water treatment device regularly.
2. Check the tightness of the connections. If the connections or seals are leaking, remove them, and if necessary, replace them.
3. Check hoses for kinks; kinked hoses should be replaced.
4. Hoses should be replaced regularly after a maximum of 5 years, or sooner if leaking.
5. Do not use caustic chemicals, cleaning solutions or detergents for cleaning.
6. Have the controls maintained and the entire appliance serviced by a qualified specialist every 3 years.

## 7 Possible Malfunctions

The table below contains descriptions of possible causes and solutions to malfunctions or errors during operation of the appliance. When malfunction cannot be removed, contact the technical service.

In such a case, provide article number, model name and serial number. These data may be found in the rating plate.

Malfunction	Possible Cause	Solution
The controller does not automatically perform regeneration	Disconnect the meter cable	Reattach the meter cable
	Damaged transformer	Replace the transformer
	Damaged controller or sensor	Contact the service company Replace or repair the parts
Hardness of treated water is higher than the setting	Bypass valve is not in operating position	Move the bypass valve to the operating position
	Incorrectly installed water supply line and/or drain line	Correctly install water supply line and/or drain line

## Possible Malfunctions

Malfunction	Possible Cause	Solution
Hardness of treated water is higher than the setting	The hardness of the inlet water is higher than the setting	Reset the water hardness at the water inlet
	Resin is contaminated and unsuitable	Contact service and have the resin replaced
	Insufficient salt concentration or amount	Keep the brine tank filled with salt at all times. Clean annually.
The appliance does not take salt solution	Clogged drain line or flow regulator	Clean the drain line and flow regulator
	Clogged injector	Clean injector, replace injector housing
	No water in the brine tank	Check that the flow regulator is not clogged. Make sure the safety float is not blocked
Salty taste of treated water	Low pressure in the water supply line	Install a pressure booster pump to increase the pressure in the water supply line
	The drain line is blocked	Remove the blockage
Constant flow into the drain	Internal control leak	Clean valve, reinstall
	Pin stuck in brine	Contact the service company

## 8 Disposal

### Electrical Appliance

	<p>Electric appliances are marked with this symbol. Electrical appliances must be disposed of and recycled in a correct and environmentally friendly manner. You must not dispose of electric appliances with household waste. Disconnect the appliance from the power supply and remove power cord from the appliance.</p>
---	---

Electrical appliances should be returned to designated collection points.