

**EN**

**Instructions for Installation, Use and  
Maintenance**

**CE**

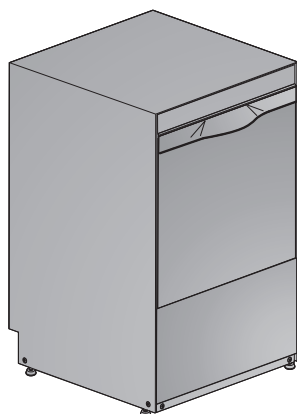



Thank you for choosing our appliance.

The installation, use and maintenance instructions given in this manual have been prepared to ensure the long life and correct operation of your appliance.

Follow these instructions carefully.

We have designed and manufactured this appliance according to the latest technological developments. Now, it is in your care.

Your satisfaction is our greatest reward.

<b>SUMMARY</b>	<b>Page</b>
<b>IMPORTANT INFORMATION</b>	<b>22</b>
<b>INSTALLER SECTION</b>	
<b>1. MACHINE INSTALLATION</b>	<b>25</b>
1.1 Receipt of the appliance	25
1.2 Water connection	25
1.3 Electrical connection	25
1.4 Temperature adjustment	26
1.5 Rinse aid dispenser operation	26
<b>2. DETERGENT DISPENSER INSTALLATION</b>	<b>28</b>
2.1 Electrical connection	28
2.2 Water connection	28
2.3 Dispensing the detergent	28
<b>3. PUMP TECHNICAL DATA AND INFORMATION</b>	<b>29</b>
3.1 Emptying pump (optional)	29
3.2 Pressure increase pump (optional)	29
3.3 Dataplate	30
<b>USER SECTION</b>	
<b>4. CONTROL PANEL AND RELATIVE SYMBOLS</b>	<b>31</b>
<b>5. OPERATION</b>	<b>31</b>
5.1 Use of detergent	32
5.2 Use of rinse aid	32
5.3 Discharge pump system (optional)	32
5.4 Regeneration device (optional)	32
5.5 Compliance with hygiene regulations and H.A.C.C.P.	33
<b>6. MAINTENANCE</b>	<b>34</b>
6.1 Regular maintenance	34
6.2 Special maintenance	34
<b>7. ALARMS</b>	<b>34</b>
<b>8. ENVIRONMENTAL FEATURES</b>	<b>35</b>
8.1 Packing	35
8.2 Disposal	35
<b>9. ECOLOGICAL FEATURES</b>	<b>35</b>
9.1 Recommendations for optimum energy, water, and additive consumption	35
<b>GENERAL INFORMATION</b>	
<b>10. TROUBLESHOOTING</b>	<b>36</b>



**READ THE INSTRUCTIONS CAREFULLY BEFORE INSTALLING THE MACHINE.**



**WARNING: FAILURE TO COMPLY (EVEN PARTIALLY) WITH THE RULES GIVEN IN THIS MANUAL WILL INVALIDATE THE PRODUCT WARRANTY AND RELIEVES THE MANUFACTURER OF ANY RESPONSIBILITY.**



## INSTRUCTIONS

This instruction booklet must be kept with the dishwasher for future consultation. If the dishwasher is sold or transferred to another user, make sure the booklet always goes with the appliance so that the new owner can have the necessary information on operation and the relative instructions.

The instruction booklet must be carefully read before installation and first use of the dishwasher.

These instructions are supplied to safeguard the user in compliance with Directive 2006/95/CE as amended and the “harmonized product Technical Standard” EN 60335-1 and EN 60335-2-58.

- **ADAPTATION OF THE ELECTRICAL AND WATER SYSTEMS FOR DISHWASHER INSTALLATION MUST ONLY BE CARRIED OUT BY QUALIFIED OPERATORS.**
- This dishwasher must only be used by adults. This is a professional machine to be used by qualified personnel, and installed and repaired exclusively by a qualified technical assistance service. The Manufacturer declines any responsibility for improper use, maintenance or repair.
- The appliance is not to be used by children or persons with reduced physical, sensory or mental capabilities, or lack of experience and knowledge, unless they have been given supervision or instruction.
- Children being supervised not to play with the appliance.
- Accompany the door in opening and closing.
- Make sure the dishwasher is not resting on the power cord or the filling and drain hoses. Level the machine by adjusting the support feet.
- Do not use the appliance or any part of it as a stepladder or means of support as it has been designed exclusively to bear the weight of the dishrack containing dishes to be washed.
- **The dishwasher is designed only and solely for washing plates, glasses and various pots and pans with human food type of residue. DO NOT wash articles polluted with petrol, paint, bits of steel or iron, fragile objects or material not resistant to the washing process. Do not use acidic corrosive chemical products or alkaline and solvents or chlorine based detergents.**
- Do not open the dishwasher door when it is working. In any case, the dishwasher has a special safety device which immediately stops it if the door is accidentally opened, thus preventing water spillage. Remember to always switch the dishwasher off and empty the tank before accessing the inside for cleaning or any other purpose.
- **After use, at the end of the day and for any kind of maintenance, it is advisable to disconnect the dishwasher from the power supply by means of the service switch and the main wall switch. Close the water supply cock.**
- The user must not carry out any repair and/or maintenance operations. In any case contact qualified personnel.
- Servicing of this dishwasher must be performed by authorized personnel.  
**N.B.: Only use original replacement parts. Otherwise the product warranty is invalidated and the manufacturer is no longer responsible.**
- **Do not use old load pipe, but only new ones.**
- Some important rules must be followed for using this appliance:
  - 1) never touch the appliance with wet hands or feet;
  - 2) never use the appliance when barefoot;
  - 3) do not install the appliance in places exposed to water sprays.
- Do not dip bare hands into water containing detergent. If this should occur, wash them immediately with plenty of water.
- Only follow the instructions given in the manufacturer’s booklet for cleaning operations (chap. 6)
- This appliance is designed to work at room temperatures up to a max. 35°C, in a suitable place with temperature not below 5°C.

- Do not use water to put out fires on electrical parts.
- Do not clog the intake or dissipation grids.
- Only qualified personnel can access the control panel after power is switched off.
- The machine has an IPX3 rating of protection against accidental splashes of water. It is not protected against pressurized jets of water, so it is recommended that pressure cleaning systems not be used.



**CAUTION: WAIT 10 MINUTES AFTER THE APPLIANCE HAS BEEN TURNED OFF BEFORE CLEANING THE INSIDE.**

**CAUTION: DO NOT PUT HANDS IN THE APPLIANCE AND/OR TOUCH THE PARTS ON THE BOTTOM OF THE TUB DURING AND/OR AT THE END OF A WASHING CYCLE.**

**NOTE: The manufacturer declines any responsibility for accidents to people or things deriving from failure to observe the rules stated above.**



**ATTENTION:**

At the end of installation make sure to remove the parts of this booklet relevant to the installer, for future consultation.

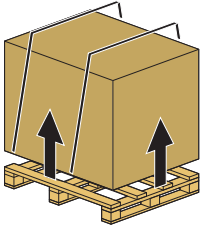
**1. MACHINE INSTALLATION****1.1 Receipt of the appliance**

After removing the packing, ensure that the appliance has not been damaged in transport. If it has, inform the retailer. If safety has been compromised, do not install the machine. For disposal of the packing, see ch.8.

**1.2 Water connection**

Pressure Table	Min.	Max.
	kPa	kPa
Static Pressure	250	400
Dynamic Pressure	200	350
Water hardness	2°f	10°f

table 1

H <sub>2</sub> O supply temperature table	
Machine upon request	Standard Macchine from catalogue
H <sub>2</sub> O Cold	H <sub>2</sub> O Hot
5°C ≤ t < 50°C	50°C ≤ t ≤ 60°C

table 2

Connect the machine's water supply with an interrupt valve capable of quickly and completely shutting off water intake.

Make sure that the water supply pressure comes within the values given in the Table 1. If it is less than 2 bar dynamic pressure (200 kPa) a pressure pump must be installed to guarantee optimal machine operation (by request, the dishwasher can be supplied with a pump).

If, however, the water supply pressure is greater than 400 kPa, a pressure reducing device must be installed.

For water with average hardness greater than 10°Fr., a water softener **must be used**.

This will result in cleaner dishes and longer life of the appliance.

By request, the machine can be equipped with a water softener (see chap. 5.4).

All damages caused by the hydraulic limestone (calcareous water higher-up than 10°F and without watersoftner) are not are not covered by warranty.

In order to ensure the optimum performance, the water supply temperature must come within the range given in table 2.

Each machine is provided with a rubber tube with a 3/4" threaded attachment for water filling.

Connect the emptying tube, supplied with the appliance, to the union elbow located under the tub so that water flows freely. If it is not possible to empty the water at a level lower than the drain of the appliance, it is advisable to install an emptying pump, which can be provided by request.

The emptying tube should always be connected to a siphon to prevent odor back-up from the screen.

**1.3 Electrical connection**

The electrical connection must be made according to current technical standards.

Ensure that the mains voltage corresponds to the value given on the machine dataplate.

**Install a suitable omnipolar thermal magnetic circuit breaker, dimensioned according to absorption, with a contact opening of at least 3 mm.**

**This circuit breaker must be exclusively used for this purpose and installed in the immediate vicinity.**

**Make sure that the electrical systems are suitably earthed.**

**On the back of the appliance there is a terminal marked with the symbol (see Pict. 1), which is provided for equipotential connection between different appliances (see electrical safety standards).**

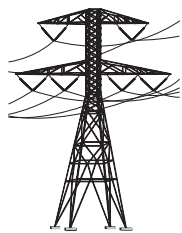

pict. 1



FOR APPLIANCES USING A THREE-PHASE POWER SUPPLY, FOLLOW THE INSTRUCTIONS AND WIRING DIAGRAM ATTACHED TO THE APPLIANCE.

ATTENTION TO CORRECT SENSE OF TRI-PHASES PUMPS ROTATION (if present).

Feed cable: the retailer - importer - installer must ensure that the feed cable complies with the cable insulation category of the workplace, in conformity with current Technical Standards.

**1.4 Temperature adjustment**



If necessary, the water temperature of the wash and rinse cycles can be adjusted by means of the fine-adjustment screws on the respective thermostats.

The recommended temperatures are 55°C for the wash cycle (tub) and 85 - 90°C for the rinse cycle (boiler). Machines with boiler inside the washing tub have only one thermostat which should be set at 75-80°C.

**1.5 Rinse aid dispenser operation**

**Technical characteristics**

**Operation:** It utilizes the difference in combined pressure caused by turning the washing pump on and off, and the rinse pressure.

**Water connection:**

- 1) Connect the dispenser tube fitting (A) to the pump, by means of the rubber tube installed in the appliance (pump pressure).
- 2) Connect the small black rubber tube by the brass delivery fitting (B) to the connection in the boiler (injector).
- 3) Make sure that the green product suction tube is inserted on the special fitting (C) and that the small filter and the ballast are inserted in the rinse aid tank.

**Priming:** To prime the dispenser, turn on the appliance and carry out several complete wash cycles or press the adjustment screw (D) during the wash cycle and open and close the door combined with pressing the pin (D). This method speeds up the refill process.

**Adjustment:** With each rinse cycle, the dispenser draws an amount of rinse aid, adjustable from 0 to 4 cc, equivalent to a length of 0 to 30 cm drawn into the suction tube.

In order to regulate the dispenser to the minimum amount, turn the adjustment screw (D) completely clockwise. For the maximum amount, turn the screw anticlockwise about 20 complete turns.

For the correct amount of rinse aid, see the paragraph **"Use of rinse aid"**.(chap. 5.2).

N.B.: for each turn of the screw the amount of the product drawn into the tube varies by 1.6 cm, equivalent to 0.2 cm<sup>3</sup>/turn (about 0.21g/turn with a concentration of 1.05 g/cm<sup>3</sup> of rinse aid). The rinse aid cannot function properly if the difference in level between the bottom of the machine and the container exceeds 80 cm.

THE DISPENSERS ARE PRE-SET TO A 5 CM OF TUBE (0,65 gr.) INTAKE OF PRODUCT FOLLOWING A TEST PHASE SYSTEM CHECK. THIS MEASUREMENT SHOULD BE ADJUSTED ACCORDING TO THE TYPE OF RINSE AID USED AND WATER HARDNESS.

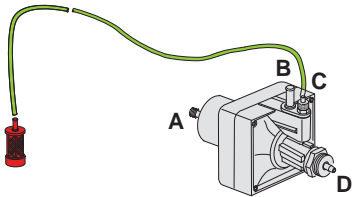

code 10799

pict. 2

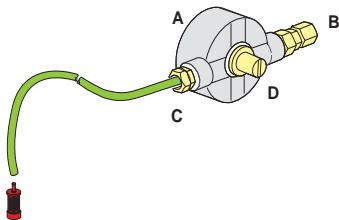

code 10799/G

pict. 3

PROBLEMS	CAUSES AND SOLUTIONS
Water exits from the rinse aid suction tube.	The suction valves 10805 - 10705/D and delivery do not seal due to foreign bodies in the closing seats. Clean the valves 10805 - 10705/D, check that the rinse aid suction filter is present, and filter the water entering the dishwasher.
The dispenser does not draw rinse aid.	a) the delivery valve 10805 - 10705/D does not seal due to foreign bodies in the closing seats. Clean the valve 10805 - 10705/D, check that the rinse aid suction filter is present and filter the water entering the dishwasher.
	b) The piston seal 10806 does not hold because it is damaged. Replace the seal 10806 with an original.
	c) check the diaphragm 10807 - 10705/O.





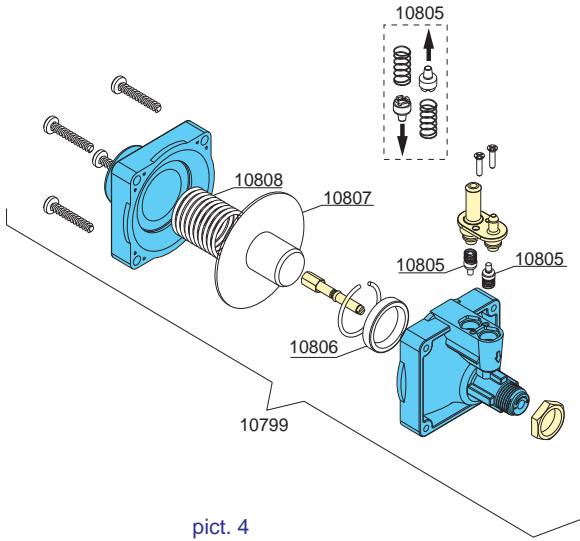

pict. 4

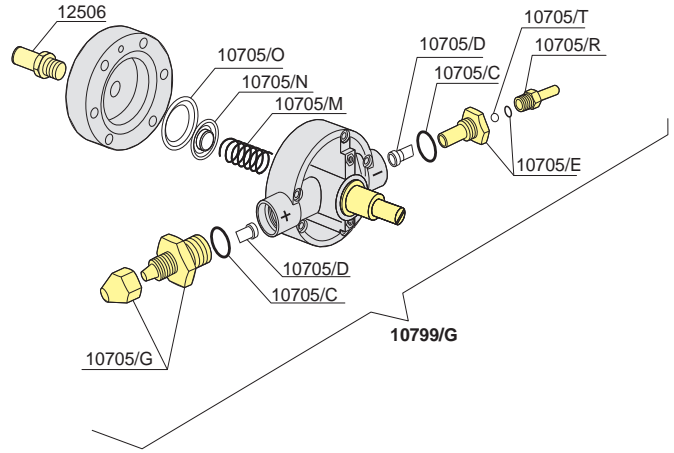

## 2. DETERGENT DISPENSER INSTALLATION

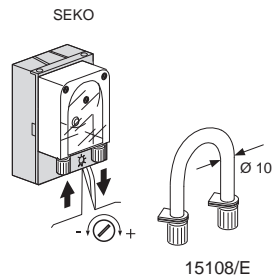

pict. 6

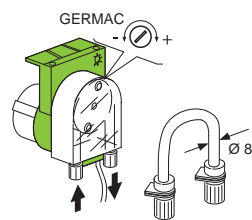

15185

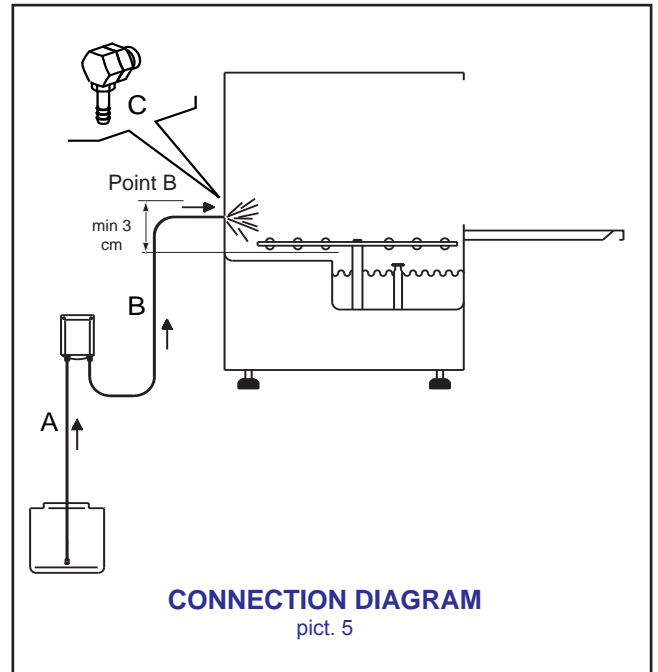

### 2.1 Electrical connection

Follow the wiring diagram attached to the machine.

### 2.2 Water connection

- a) A  $\text{Ø}12$  hole must be made on the back of the appliance.  
In some appliances the hole has already been made and is closed with a plastic cap. Remove the cap from the hole and fit the delivery connection.
- b) Otherwise, drill one of the same diameter as the injector on the back part of the tub (see pict. 5). This operation must be carried out by the Technical Service.  
The hole must be made above the water level.  
Important: make the hole in a position distant from the overflow tube, so that detergent does not flow out immediately. Fix the dispenser in a vertical position with tube connectors turned downwards, making sure not to place it on energized components.  
Clean the inside of the machine from any drilling residual.
- c) Correctly mount the injector (C) using the appropriate fixtures.
- d) Connect the suction tube to the suction attachment of the dispenser (see pict. 5 point A).
- e) Connect the delivery tube to the other attachment of the dispenser, and the delivery fitting (see pict. 5 point B).
- f) Insert the suction tube with filter in the detergent tank.
- g) Prime the detergent and proceed to dispense.

### 2.3 Dispensing the detergent

The detergent dispenser capacity can be adjusted using a screwdriver as shown in pict. 6. Every 2 cm of product drawn into the tube corresponds to  $0.25 \text{ cm}^3$  equivalent to 0.3 g (with a concentration of  $1.2\text{g}/\text{cm}^3$ ). For proper dispensing see paragraph 5.1.



### 3. TECHNICAL DATA AND USEFUL INFORMATION ON PUMPS

#### 3.1 Emptying pump (optional)

How installing, pay particular attention to the position of the emptying tube (see pict. 7). See chapter 5.3. for operations description.

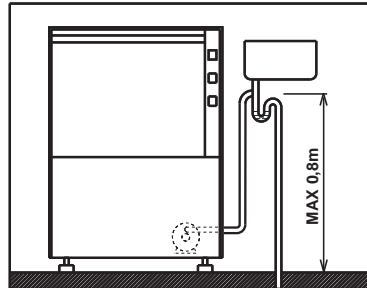
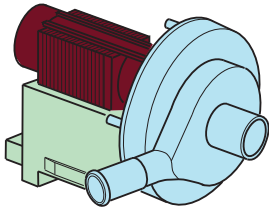

pict. 7

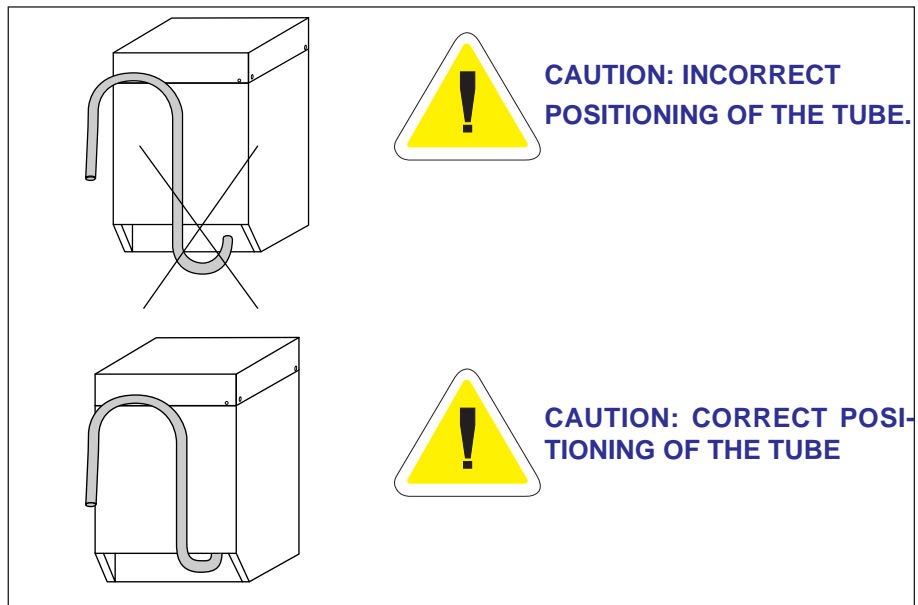

#### 3.2 Pressure increasing pump (optional)

When the dishwasher has not been used for some time, check that the supplementary pressure increasing pump turns freely.

To do this, operate using a screwdriver in the special slot on the ventilating side of the motor shaft (see pict. 8).

In case of blocking, turn the main switch off and move the motor shaft, inserting the screwdriver in the notch, turning it clockwise and anticlockwise.

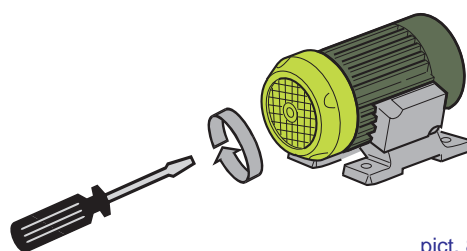

pict. 8

3.3 Dataplate

**Code** DW 999XXXXYY  
**Model DESCRIPTION**  
**S/N** DW A 1015770      **Type** .....

**400V 3N 50HZ 3500W**      **8A 500W**

**IPX3**      **16A**

**200-500 kPa**

**TECHICAL SPECIFICATION**

**MADE IN ITALY**

Pressione Dinamica alimentazione idrica  
 Pression dynamique arrivèe d'eau  
 Dynamic pressure water supply  
 Dynamischer Druck asserreinlauf

Pressione dinamica vapore saturo  
 Pression dynamique vapeur satueèe  
 Dymanischer Druck gesattigter Dampf  
 Pression Dinamica Vapor Saturado

Temperatura massima acqua in ingresso 60°C  
 Temperature max eau a l'entre  
 Maximale Temperatur Wasseranschl  
 Maximum Water temperature in-feeding

**Model**      **S/N**

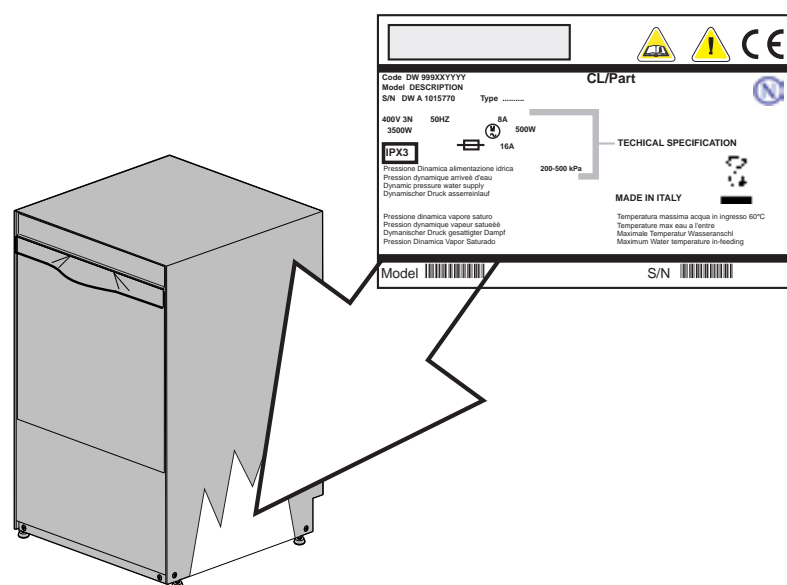
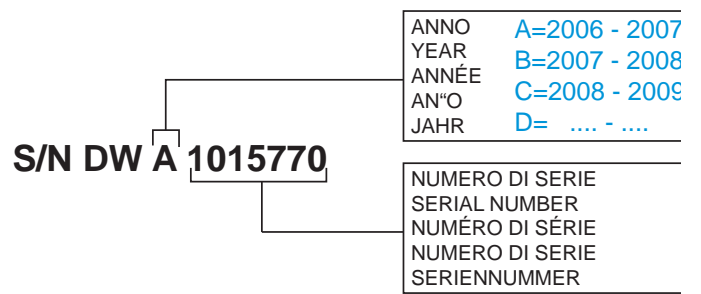
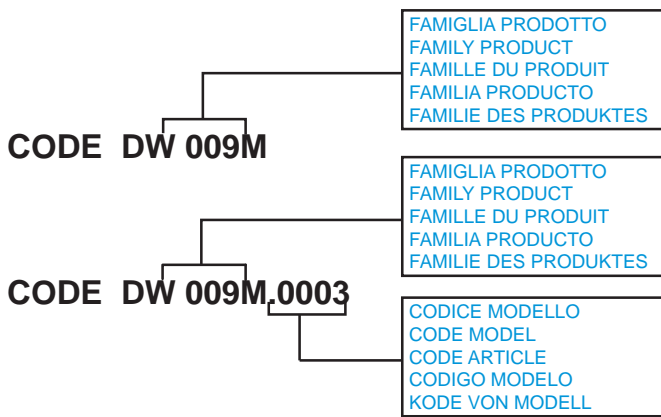

## 4. CONTROL PANEL AND RELATIVE SYMBOLS

### CONTROLS

1		Main switch 0-1
2	<b>START</b>	Cycle START button
3		Cooling glasses button (optional)
4		Regeneration START button (optional)
5		Manual empty button (optional)
6		Wash type selector (if provided)

### INDICATORS

a		Power on indicator
b		Tub full indicator
c		Washing cycle indicator
d		Regeneration cycle indicator
e		Temperature indicator

## 5. OPERATION

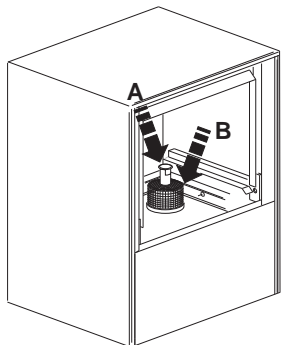

pict. 9

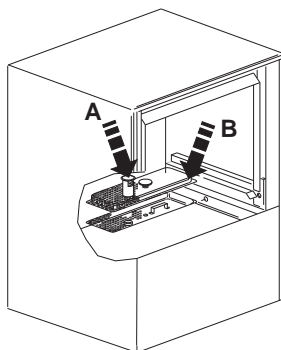

pict. 10

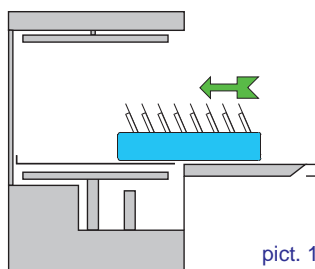

pict. 11

- Check that the filter (B) is correctly fitted in its seat (pict. 9-10). The filter must be cleaned after every 20 wash cycles and whenever necessary. DO NOT use the appliance without the filter.
- Insert the overflow tube (A) in the special seat inside the tub (pict. 9-10)
- Close the dishwasher door.
- Insert the special rinse aid dispenser tube in the liquid container and check that the quantity of additive is sufficient for daily use (see chap. 5.2 "Use of rinse aid").
- Open the water tap and plug in the main switch.
- Turn switch 0-1 (see chap. 4) to position 1 (pressed). The operation is signalled by the switch indicator lighting up or by the indicator with the symbol (a) (see chap. 4). The machine will automatically fill the tub with water; (indicator (b) - see chap. 4 - when present will turn on, indicating the tub is full) then the heating phase begins. Indicator (e) (see chap. 4) comes on when the water temperature is reached.
- Insert the rack filled with dishes to wash. The plates must be correctly placed in the rack (see pict. 11).
- On machines with selector 6 (see chap. 4), select the wash cycle required.
- Before starting the wash-cycle, in absence of an automatic dosing system, pour the detergent in the wash-tank. When the temperature indicator (e) will turn on, press the START 2 button (see chapter 4) for at least a second. The beginning of the cycle is indicated either by the light on the button itself or on the (c) lamp. At the end of the washing cycle, a hot rinse cycle will take place. The indicator light of the START button 2 or the (c) lamp (see chap. 4) will turn off when the cycle has finished. At cycle end with the door closed, dishes do not get dried. Take out the basket or keep the door open to allow the evaporation and the drying of the dishes. To carry out a cooling glasses cycle, on appliances equipped with this option, press button 3 (see chap. 4) and hold it down for the desired length of time after the indicator light C goes off. After this cycle, the glasses remain wet.
- The appliance is now ready for a new wash.
- At the end of the day, clean the machine (see chap. 6 "Maintenance").
- Turn off the machine and the water tap.
- Turn off the main wall switch.



### 5.1 Use of detergent

ONLY use NON FOAMING types suitable for industrial glass-washers and dishwashers. It is advisable to use liquid detergents.

Put the detergent directly in the tub.

The correct amount will be suggested by the product manufacturer according to the water hardness. By request, the dishwasher can be equipped with an electric detergent dispenser (always recommended).

1cm. of the product drawn into the tube is equal to about 0.15 g. A correct amount of detergent is very important for a successful wash.



### 5.2 Use of rinse aid

The machine is equipped with a rinse aid dispenser.

The machine automatically draws the product.

The amount dispensed can be regulated by operating the fine-adjustment screw on the dispenser.

Reduce the amount by turning the screw clockwise, increase by turning it anticlockwise.

The recommended amount is 2-5 cm of product measured on the suction tube. 1 cm of the product drawn into the tube is equal to about 0.13g. A correct amount of rinse aid is very important for a quick and clean drying.

### 5.3 Discharge pump system (optional)

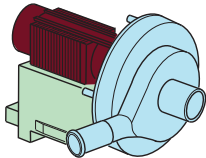

To drain completely the wash-tank keep the machine ON, extract the overflow pipe and shut the door. Press the button (5 - see chap. 4) for at least a second: the discharge pump will automatically drain the wash-tank.

When the drain is completed, turn the machine OFF.

Turn the machine OFF and, after 5 seconds, ON (button 1 - see chap. 4) to fill the wash-tank and run a new cycle.

Opening the door will stop the machine that will re-start when the door is shut.

During the wash-rinse cycle the water in excess is automatically drained.

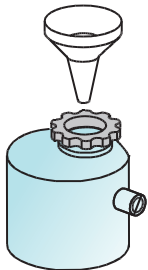

pict. 12

### 5.4 Regeneration device (optional)

Resin regeneration by the water softener is very important.

Resin regeneration: resin regeneration should be carried out according to the number of cycles as indicated in the picture below. Ex. 27°F (or 15°D) = 39 cycles.

To carry out the purifying cycle, follow these instructions:

- Open the water tap and plug in the main switch.
- Turn the main switch 1 (see chap. 4) to 1 (OFF).
- Open the door.
- Remove the overflow tube and empty all the water in the tub.
- Once the tank is empty check and fully replenish the salt, being careful not to spill it on the tank itself. A strong concentration of salt can negatively affect the correct functioning and service life of the machine. Fill the special container, placed on the inside of the tub, (see pict. 12) with coarse salt (1-2 mm. grains - the maximum capacity of the bowl is 500 gr.).
- Close the door, press button (4 - see chap. 4) for 5 seconds and wait for the turn on of the indicator light (d) - see chap. 4. The indicator light (d) will come on when the cycle is activated. The resins contained in the purifier will be automatically regenerated in about 20 minutes. The cycle is completed when the indicator light (d) goes off. Wait 20 seconds before opening the door.

Before opening the door, please wait 20 seconds.

After the softening cycle, switch the machine off with button (1 - see chap. 4).

Turn off the main wall switch.

P.S.: once the cycle has begun it cannot be stopped.

If a water conditioner is installed externally, follow the instructions given in the relative manual to regenerate the resins.

- The flashing of the cycle lamp during the softening cycle, indicates a malfunction or a missed draining of the wash-tank (see chapter 7).



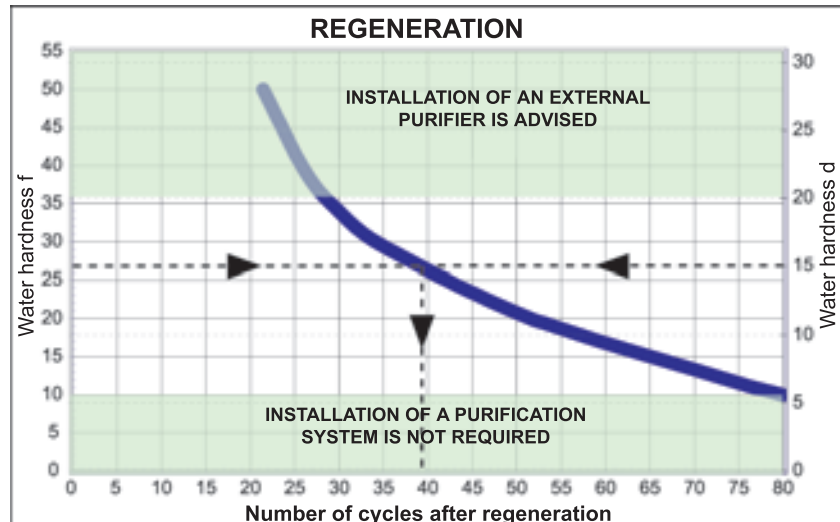

In the case of water hardness above 35°F it is advisable to install an external water softener.

### 5.5 Compliance with hygiene regulations and H.A.C.C.P.

- The machines are equipped with a temperature indicator (e - chap. 4) which lights up when the boiler and the tub have reached the preset temperature (values set by the manufacturer). It is recommended to wait for this light to go on before starting the next cycle.
- Scrape food from the dishes carefully in order not to clog the filters, nozzles and pipes.
- Unload the wash tub and clean the filters at least twice a day.
- Check that the amount of detergent and rinse aid dispensed is correct (as suggested by the supplier of the product). In the morning before starting up the machine, check that there is enough product in the containers for daily use.
- Always clean the support floor of the dishes.
- Remove the rack from the dishwasher with clean hands or gloves so as not to dirty the cutlery.
- Do not dry or polish the dishes with non-sterilized cloths, brushes, or dusters.

## 6. MAINTENANCE

### 6.1 Regular Maintenance



**WARNING:** The machine is not protected against water jets, therefore do not use pressure cleaning systems.

Contact your cleaning products retailer for detailed instructions on the methods and products to use for periodic sanitizing of your appliance. **DO NOT use bleach or chlorine-based detergents for cleaning the appliance.**

In order to ensure perfect performance, the appliance must be completely cleaned at least once a day in the following way:

- Turn the switch to 0 (1 - see chap. 4).
- Switch off the main switch.
- Turn off the water tap.

- Remove the overflow tube to empty the water.

For appliances provided with emptying pump follow the indications as described on paragraph 5.3.

- Remove the filter and clean it with a brush under running water.
- Remove the rotors by loosening the fixing screws, and thoroughly clean the nozzles and cleaning and rinsing arms under running water.
- Reassemble all parts and refit the rotors in their seats, fixing them with the relative screws.
- Clean the tub thoroughly using specific products.
- At the end of the day, it is advisable to leave the dishwasher door open.

**N.B.:** It is advisable to replace the tub water by refilling the tub at least every 20 wash cycles, or twice a day. Do not use metal brushes or corrosive products which can damage the machine.

### 6.2 Special Maintenance

Once or twice a year have a qualified technician inspect the machine:

- 1 To clean the electrovalve filter.
- 2 To remove residual deposits.
- 3 To check the watertight of the seals for water loading and unloading connections.
- 4 The condition and/or wear of the components.
- 5 The operation of the dispensers.

## 7. ALARMS



TYPE OF ALARM	CAUSE	REMEDIES
Flashing of the cycle lamp	Missed refill of water in the wash-tank	Verify the full opening of the water inlet valve or the right positioning of the overflow pipe. Switch the machine OFF and ON to reset the alarm
	Missed heating of the water boiler (in machines equipped with Thermostop)	Boiler thermostat or boiler heating element out of order. Check them or call for Service
Flashing of the softening lamp	Missed tank emptying	remove the overflow pipe and drain the tank. Switch the machine OFF and ON to reset the alarm



## 8. ENVIRONMENTAL FEATURES

### 8.1 Packing



The packing consists of the following:

- a wood pallet;
- a nylon bag (LDPE);
- multi-layered cardboard;
- polyurethane foam (PS);
- polypropylene support (PP).

We kindly advise you to dispose of the above-mentioned material in accordance with current environmental regulations.

### 8.2 Disposal



The use of the WEEE Symbol indicates that this product may not be treated as household waste. By ensuring this product is disposed of correctly, you will help protect the environment. For more detailed information about the recycling of this product, please contact your local authority, your household waste disposal service provider or the shop where you purchased the product.

For the disposal of the machine or one part of its, please follow the directives 2002/95/CE, 2002/96/CE and following changes and/or the legislative decrees of application.

This product or parts of it cannot be disposed of as domestic waste but must be treated by means of separate collection (see barred waste container symbol on product).

At the time of product disposal, the user must refer to the specific waste collection systems for electric and electronic appliances (WEEE).

The manufacturer guarantees the absence of dangerous substances in the EEE's used in compliance with the 2002/95/CE Directive.

In the case of failure to comply with that prescribed, the user will be subject to the sanctions envisioned by the individual European Community member.

Disconnect the machine from the electrical and water supply before disposal.

Cut off the electrical cable in order to make any other use impossible.

All the metal parts are recyclable as they are in stainless steel.

Recyclable plastic parts are marked with the symbol of the plastic material.



## 9. ECOLOGICAL FEATURES

### 9.1 Recommendations for optimum energy, water, and additive consumption

#### Dispensing of salt

A pre-set quantity (by the manufacturer) of salt is injected in the resins every regeneration cycle. It is important to observe the number of regeneration cycles recommended in paragraph 5.3 in order to avoid salt spills or lime deposits.

#### If possible operate the machine at full capacity.

Thus avoiding a waste in detergent, rinse aid, and electrical and water consumption.

#### Detergents and rinse aids

Out of respect for the environment, use detergents and rinse aids with the highest biodegradability. Check the correct amount according to the water hardness at least once a year. An excessive amount of the product will pollute rivers and seas, an inadequate quantity will preclude proper washing and/or cleanliness of the dishes.

#### Temperature of the tub and boiler

The temperature of the tub and boiler are set by the manufacturer in such a way as to ensure the best washing results from the majority of detergents on the market. These may be re-set by the installer according to your detergent (see chap.1.4).

#### Removal of food

Carefully scrape food from the dishes using lukewarm water in moderation to help in the removal of animal fat. To successfully remove caked on material, soaking in hot water is recommended.

#### Note:

Wash dishes as soon as possible to prevent hardening of the deposits and compromising the effectiveness of the washing.

For an effective washing process, regular cleaning and maintenance of the dishwasher is recommended (see chap.6).

**Non-compliance with the above recommendations or with any and all information within the manual could result in a waste of energy, water, and detergent, further causing an increase in user costs and/or a reduction in performance.**

## 10. TROUBLESHOOTING

Type of Problem	Possible Causes	Cure
The appliance does not start	The main switch is turned off	Turn on the switch
The appliance does not draw water	The water tap is closed	Open the water tap
	The rinsing arm nozzles or the electrovalve filter are clogged and/or caked with lime deposits	Clean the rinsing arm nozzles, the pipes and the electrovalve filter. If the machine has a water purifier check the salt content or regenerate the resins more often
	Faulty pressure switch	Replace the pressure switch (call the Technical Assistance service)
Flashing of the cycle lamp	See chapter 7 "Alarms"	
Unsatisfactory washing results	The washing nozzles are clogged or the washing arms do not rotate	Unscrew and clean the nozzles and the rotating column, refit them correctly in their seats
	Unremoved grease or starch	Detergent concentration too low
	The filter is too dirty	Remove the filter, clean it with a brush under running water and refit in its seat
	Check the tub temperature (it must be between 50°C and 60°C)	Adjust the thermostat or check correct heating element operation
	Length of washing cycle inadequate for type of grime build-up	Choose a longer cycle if possible, otherwise repeat wash cycle
	Wash water too dirty	Empty water from the tub, clean filters; refill the tub and correctly reposition the filters
Presence of foam	Use of unsuitable products	Use non-foaming detergent or use less of same detergent
	Tub temperature too low	Adjust the thermostat or check correct heating element operation
Glasses or dishes are not completely dry	Insufficient rinse aid	Increase the amount of rinse aid by turning the screw on the dispenser (see paragraph "Rinse aid dispenser")
	The rack is unsuitable for the glasses and dishes	Use a suitable rack enabling the dishes to be tilted so water can run off
	The dishes have been too long in the tub	As soon as the wash cycle is finished, pull the rack out immediately, allowing the air to dry the glasses and dishes more quickly
	Rinse water temperature is less than 75°C - 80°C	Check the temperature of the boiler thermostat
	Surface of dishes and glasses too rough or porous for material wear	Replace type of dishes and glasses used
Streaks and spots on glasses and dishes	Too much rinse aid	Decrease the amount of rinse aid by turning the fine-adjustment screw on the dispenser (see paragraph "Rinse aid dispenser")
	The water is too hard	Check the water hardness. Water should not be harder than 5-10 °f
	For appliances with conditioners: too little salt in the salt container or the resins have not been properly regenerated	Fill the salt container (coarse salt: 1-2 mm grains) and regenerate the resins more often. If lime deposits are also observed on the body of the machine, have a qualified technician check the operation of the purifier
	Salt present in dishwasher tub	Thoroughly clean and rinse the appliance, and avoid spilling salt when filling the container
The appliance suddenly stops during the cycle	The appliance is connected to an overloaded circuit	Connect the appliance separately (call the Technical Assistance service)
	A safety device has been activated	Check safety devices (call the Technical Assistance service)
During wash cycle the machine stops and draws water	Water from the previous day has not been replaced	Empty the tub and refill it
	The tub water temperature is too high	Have the Technical Assistance service check the thermostat and the pressure switch
	Faulty pressure switch	
The booster pump can't prime	The overflow tube is incorrectly positioned	Remove the overflow tube and correctly reposition it
	Little pressure on feeding	Take out the boiler pipe and drain the pump

**N.B. For any other problems, contact the Technical Assistance service.**

**The manufacturer reserves the right to alter the technical characteristics without prior notice.**